

DEWATS

Decentralised Wastewater Treatment in Developing Countries

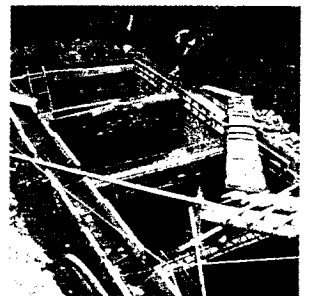

Ludwig Sasse
1998

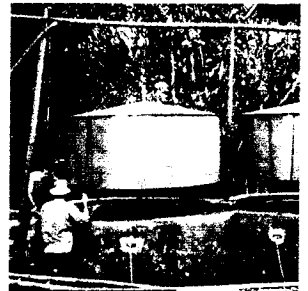
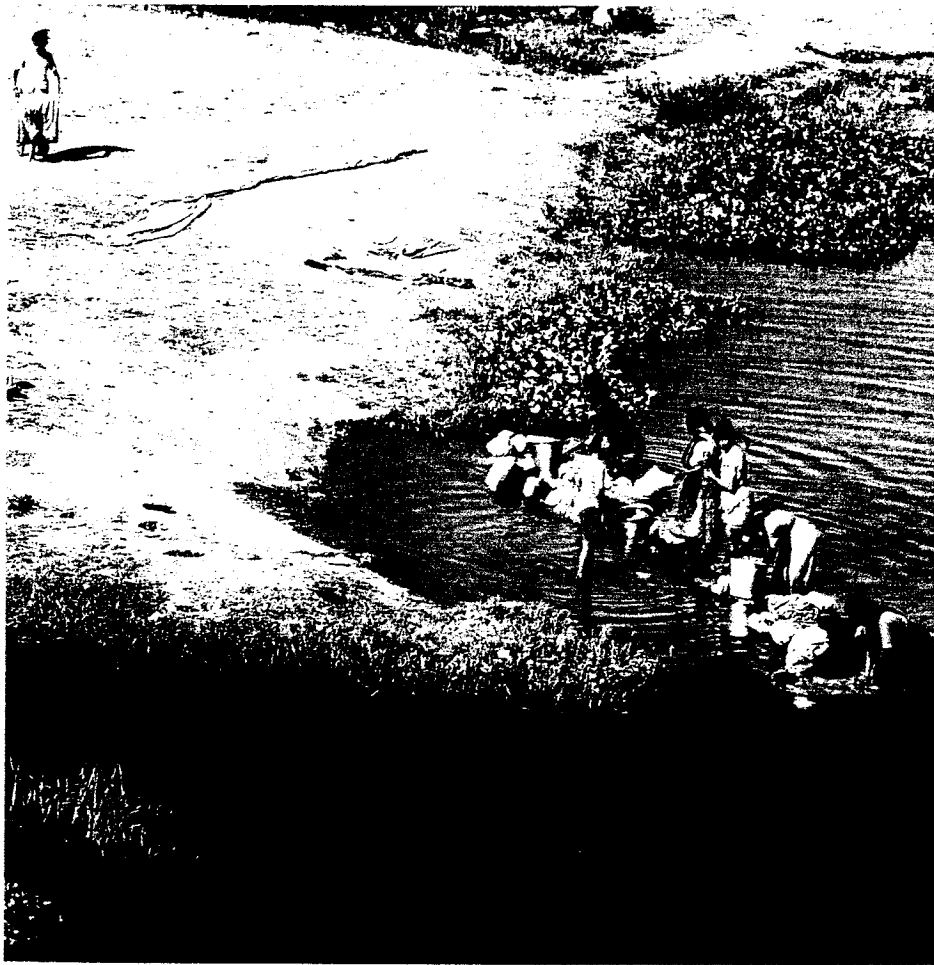

Dear reader,

I am inconsolable to have to inform you that not all errors could be eliminated before printing. Please forgive and bear with me. I ask you most humble to correct the following mistakes (not to mention minor printing errors):

Page 14, chapter 2.4.1, first paragraph, line 6: ambiguous must be replaced by **ambitious**

Page 94, Fig. 39: Section and Plan is to be interchanged

Page 75, chapter 9.4, right column, line 14: not 300 m³ per m² but **300m² surface area per m³** is correct

Page 93, just above chapter 9.11: (Fig. 133) must be replaced by **(Tab.28)**

Page 116, chapter 12.1. 3rd line from top: carbohydrate must be replaced by carbon dioxide

Page 119, Fig. 58: This plant had been constructed by LPTP and BORDA for cattle dung in a meat factory in Central Java – and not in Orissa, India

Page 141, formula of cell J5 should better start from 0% BOD removal, it reads then:

$$J5=IF(F5<0,4;(F5*0,22/0,4);IF(F5<0,75;(F5-0,4)*31/35+0,22;IF(F5<0,8;(F5-0,75)*9,5/5+0,605;IF(F5<0,85;(F5-0,8)*12,5/5+0,7;IF(F5<0,9;(F5-0,85)*17,5/5+0,825;(F5-0,9)*30/5+1))))))$$

Page 146, formula of cell E11, in the second **and** fourth line: 1,16 must be replaced by **1/1,16**

Page 152, SI/US-unit for kWh to kJ must be 0.000**28** and last line, last formula must be 1,8(^oK)-460

Page 156, after Mara must follow

Metcalf & Eddy: »Wastewater Engineering, Treatment - Disposal - Reuse«, third edition, TATA McGraw-Hill Edition, New Delhi, 1995

We have further improved **Tab. 26** on page 135 in order to take better care of weaker wastewater. The existing Tab. 26 is still valid for stronger wastewater, however the new Tab. 26 is more comprehensive. I propose to cut out the existing pages 133–136 and insert the attached **new pages 133-136** instead. – ~~DONE~~!

Ludwig Sasse

DEWATS

Decentralised Wastewater Treatment in Developing Countries

Ludwig Sasse
1998

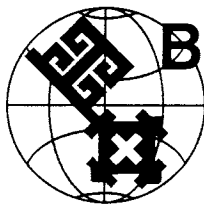

BORDA

Bremen Overseas Research and Development Association
Bremer Arbeitsgemeinschaft für Überseeforschung und Entwicklung
Association Brêmeoise de Recherche et de Développement d'Outre Mer
Industriestrasse 20, D-28199 Bremen

The Author:

Ludwig Sasse, civil engineer, responsible for biogas and wastewater projects of BORDA since 1980, editor of the BORDA BIOGAS FORUM, wrote several books and articles on biogas and wastewater technology and dissemination.



This publication of BORDA was prepared with the financial assistance of The European Commission, Directorate - General IB/D4, Environment and Tropical Forest Sector, Rue de la Loi 200, B - 1049 Bruxelles, Belgium

and



The Free Hanseatic City of Bremen, Senator of Ports, Transport and Foreign Trade, State Office for Development Cooperation, Martini Str. 24, D - 28195 Bremen, Germany

The views expressed in this publication are those of the author and do not represent the official views neither of the European Commission nor the State Government of Bremen

Printed in Bremen 1998

CONTENTS

- 1 FOREWORD
- 2 DEWATS: PROPERTIES, PERFORMANCE AND SCOPE
 - 2.1 Properties of DEWATS
 - 2.2 Performance
 - 2.3 Scope
 - 2.4 Implementation
- 3 DISSEMINATION
 - 3.1 The Need for Active Dissemination of DEWATS
 - 3.2 Preconditions for dissemination
 - 3.3 The Social Aspect
 - 3.4 The Economic Aspect
 - 3.5 The Technical Aspect
 - 3.6 The Legal Aspect
 - 3.7 Dissemination Strategy
- 4 ECONOMICS
 - 4.1 Economy of Wastewater Treatment
 - 4.2 Treatment Alternatives
 - 4.3 Parameters for Economic Calculation
- 5 PROCESS OF WASTEWATER TREATMENT
 - 5.1 Definition
 - 5.2 Basics of Biological Treatment
 - 5.3 Aerobic - Anaerobic
 - 5.4 Phase Separation
 - 5.5 Separation of Solids
 - 5.6 Elimination of Nitrogen
 - 5.7 Elimination of Phosphorus
 - 5.8 Elimination of Toxic Substances
 - 5.9 Removal of Pathogens
- 6 ECOLOGY AND SELF PURIFICATION EFFECT
 - 6.1 Surface Water
 - 6.2 Groundwater
 - 6.3 Soil
- 7 CONTROL PARAMETERS
 - 7.1 Volume
 - 7.2 Solids
 - 7.3 Fat, Grease and Oil
 - 7.4 Turbidity, Colour and Odour
 - 7.5 COD and BOD
 - 7.6 Nitrogen
 - 7.7 Phosphorus
 - 7.8 Temperature and pH
 - 7.9 Volatile Fatty Acids
 - 7.10 Dissolved Oxygen
 - 7.11 Pathogens
- 8 DIMENSIONING PARAMETERS
 - 8.1 Hydraulic Load
 - 8.2 Organic Load
 - 8.3 Sludge Volume

9 TECHNOLOGY

- 9.1 Grease Trap and Grit Chamber
- 9.2 Septic Tank
- 9.3 Imhoff Tank
- 9.4 Anaerobic Filter
- 9.5 UASB
- 9.6 Baffled Septic Tank
- 9.7 Fully Mixed Digester
- 9.8 Trickling Filter
- 9.9 Constructed Wetlands
- 9.10 The Horizontal Gravel Filter
- 9.11 Vertical Sand Filter
- 9.12 Ponds
- 9.13 Hybrid and Combined Systems
- 9.14 Unsuitable Technologies

10 SLUDGE DISPOSAL

- 10.1 Desludging
- 10.2 Sludge Drying
- 10.3 Composting

11 REUSE OF WASTEWATER AND SLUDGE

- 11.1 Risks
- 11.2 Groundwater Recharge
- 11.3 Fishponds
- 11.4 Irrigation
- 11.5 Reuse for Process and Domestic Purposes

12 BIOGAS UTILISATION

- 12.1 Biogas
- 12.2 Scope of Use

- 12.3 Gas Collection and Storage
- 12.4 Distribution of Biogas
- 12.5 Gas Appliances

13 COMPUTER SPREAD SHEETS

- 13.1 Technical Spread Sheets
 - 13.1.1 Usefulness of Computer Calculation
 - 13.1.2 Risks of Using Simplified Formulas
 - 13.1.3 About the Spread Sheets
 - 13.1.4 Assumed COD / BOD Relation
 - 13.1.5 Wastewater Production per Capita
 - 13.1.6 Septic Tank
 - 13.1.7 Imhoff Tank
 - 13.1.8 Anaerobic Filters
 - 13.1.9 Baffled Septic Tank
 - 13.1.10 Biogas Plant
 - 13.1.11 Gravel filter
 - 13.1.12 Anaerobic Pond
 - 13.1.13 Aerobic Pond
- 13.2 Economic Computer Spread Sheets
 - 13.2.1 General
 - 13.2.2 Viability of Using Biogas
 - 13.2.3 Annual Cost Calculation
- 13.3 Using Spread Sheets without Computer

14 APPENDIX

15 LITERATURE

16 KEYWORDS

1 FOREWORD

This handbook is an outcome of a project titled

“Low Maintenance Wastewater Treatment Systems - LOMWATS; Development of Technologies and Dissemination Strategies.”

The project had been financed by the Commission of the European Union, with substantial contribution by the State Office for Development Co-operation of the Free Hanseatic City of Bremen from October 1994 until April 1998.

The following organisations participated in the project:

CEEIC (Chengdu) and HRIIEE (Hangzhou) from China; SIITRAT (New Delhi), MDS (Kanji-rapally) and CSR (Auroville) from India, and GERES (Marseilles) from France. BORDA from Germany co-ordinated the project.

This book aims at a target group which is typical for decentralised technology implementation. This group consist of people who are aware of the general problem and know something about possible solutions. However, their knowledge is too general on the one hand, or too specialised on the other to master the very typical problems which go together with decentralisation. This book wants to provide enough basic knowledge about the technology to non-technical project managers in order to enable them to adapt the technology locally. The book wants also to help the technical specialist to understand where technical simplification is required in order to disseminate the technology in its typical decentralised con-

text - and provides tables for dimensioning of treatment plants on the computer. Last but not least, the book will assist senior development planners who need to understand the specifics of decentralised wastewater treatment technology sufficiently in order to select or approve appropriate strategies for its dissemination.

Consequently, this book cannot and will not provide additional information to any of the specialists in his or her own field. On the contrary, a specialist may be irked by certain simplifications. This may make good for the fact, that practical people are often irritated by academic specialists, of both the technical and non-technical field.

There will be always a need for decentralised wastewater treatment in Developing Countries. The only realistic approach for the time being is the use of low maintenance technology. However, the abbreviation for it, namely LOMWATS, carries unjustly an image of low standard which could become counter productive to dissemination. Therefore, the name DEWATS will be used, which stands for „Decentralised Wastewater Treatment Systems“. DEWATS includes only such systems which are considered suitable for decentralised application and dissemination in the case that qualified maintenance and operation cannot be expected. Nevertheless, DEWATS technologies may also be suitable for large centralised applications. On the other hand may sophisticated technology of considerable maintenance and steering requirement also be appropriate in certain decentralised cases.

However, even the rather simple DEWATS - technologies are generally not mastered at the place of decentralised pollution. This indicates the biggest disadvantage of decentralisation, which is the need for know-how and expertise at each of the decentralised location. This book intends to improve the situation. Nonetheless, centralised guidance and supervision of decentralised activities is required which is extremely costly, and therefore, dissemination of DEWATS needs active promotion.

Acknowledgement

I would like to express my sincere thanks to all who enabled the writing of this book, either through providing funds or through sharing their rich experience. I want to thank especially those who made mistakes in the past and saved me from „falling into the ditch“ myself. Unfortunately, it would be unfair to mention their names, however, I would like to encourage everybody to openly report about own failures, because when they have been sincerely analysed they are the best teaching material for others.

The book in your hand can only be an entry point to the wide field of wastewater treatment technology. Fortunately, there are other books which describe the various sectors of the technology more profoundly. You find a long list of books and articles in the annex who's authors deserve my gratitude, however, I would like to mention three books of quite different type which were of particular help to me:

My favourite is „Biologie der Abwasserreinigung“ (*Biology of Wastewater Treatment*) by Klaus Mudrack and Sabine Kunst, be-

cause it explains the biochemical subject in such a manner that even civil engineers like myself can follow. I hope the book in your hand has something of this clarity.

Another book indispensable for a German civil engineer is „Taschenbuch der Stadtentwässerung“ (*Pocket book of Sewerage*) by the famous Imhoffs, in which one finds general guidance on „simply everything“ concerning sewage and wastewater treatment. The book has been translated into several languages under various titles and parts of it have been included into books by local authors.

The last of the trinity is „Wastewater Engineering“ by Metcalf and Eddy. Beside being a comprehensive and voluminous handbook for engineers that is based on theoretical knowledge and practical experience, it is also a textbook for students with examples for dimensioning and planning.

I would also like to thank the participants of a workshop held in Auroville, India in November 1997, whom I used without their knowledge to check the general concept of this book. I am further indebted to those to whom I have sent the draft version for comments. I am grateful for remarks and information given by D.P. Singhal, Deng Liangwei, Andreas Schmidt, Gilles B., Dirk Esser and Christopher Kellner. I would also like to thank Mr. Siepen who compiled mountains of literature for me while working as a volunteer for BORDA. My special thanks goes to Mrs. Anthya Madiath who tried hard to clean the text from the most cruel „Germanisms“ without hurting my ego too much.

Ludwig Sasse

Bremen, March 1998

2 DEWATS

PROPERTIES, PERFORMANCE AND SCOPE

This chapter gives a general overview on Decentralised Wastewater Treatment Systems technology (DEWATS) and may be considered being a summary of its essentials. It is meant for development planners or politicians, especially, who tend to not to go deep into technical details before making their decisions.

2.1 Properties of DEWATS

2.1.1 DEWATS

- ❑ DEWATS is an approach, rather than just a technical hardware package.
- ❑ DEWATS provides treatment for wastewater flows from 1 - 500 m³ per day, from both domestic and industrial sources.
- ❑ DEWATS is based on a set of treatment principles the selection of which has been determined by their reliability, longevity, tolerance towards inflow fluctuation, and most importantly, because these treatment principles dispense with the need for sophisticated control and maintenance.

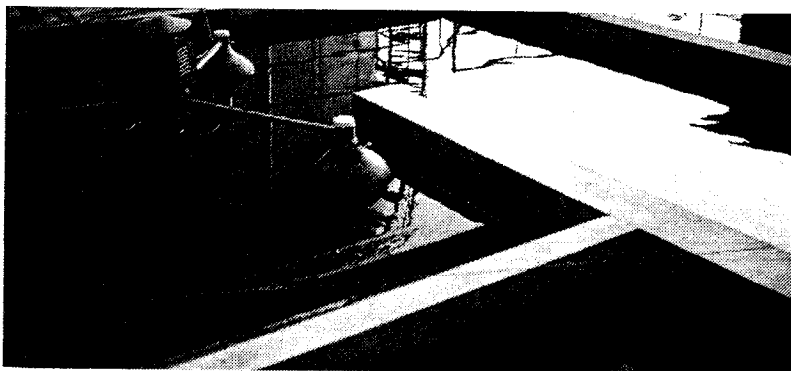

- ❑ DEWATS work without technical energy, and thus cannot be switched off intentionally (see *Fig. 1*).
- ❑ DEWATS guarantees permanent and continuous operation, however, fluctuation in effluent quality may occur temporarily.
- ❑ DEWATS is not everywhere the best solution. However, where skilled and responsible operation and maintenance cannot be guaranteed, DEWATS technologies are undoubtedly the best choice available.

2.1.2 Treatment Systems

DEWATS is based on four treatment systems:

- ❑ Sedimentation and primary treatment in sedimentation ponds, septic tanks or Imhoff tanks
- ❑ Secondary anaerobic treatment in fixed bed filters or baffled septic tanks (baffled reactors)
- ❑ Secondary and tertiary aerobic / anaerobic treatment in constructed wetlands (subsurface flow filters)

Fig. 1.
One of too many non-aerating aerators [photo: Sasse]

- Secondary and tertiary aerobic / anaerobic treatment in ponds.

The above four systems are combined in accordance with the wastewater influent and the required effluent quality. Hybrid systems

or a combination of secondary on-site treatment and tertiary co-operative treatment is also possible.

The Imhoff tank is slightly more complicated to construct than a septic tank, but

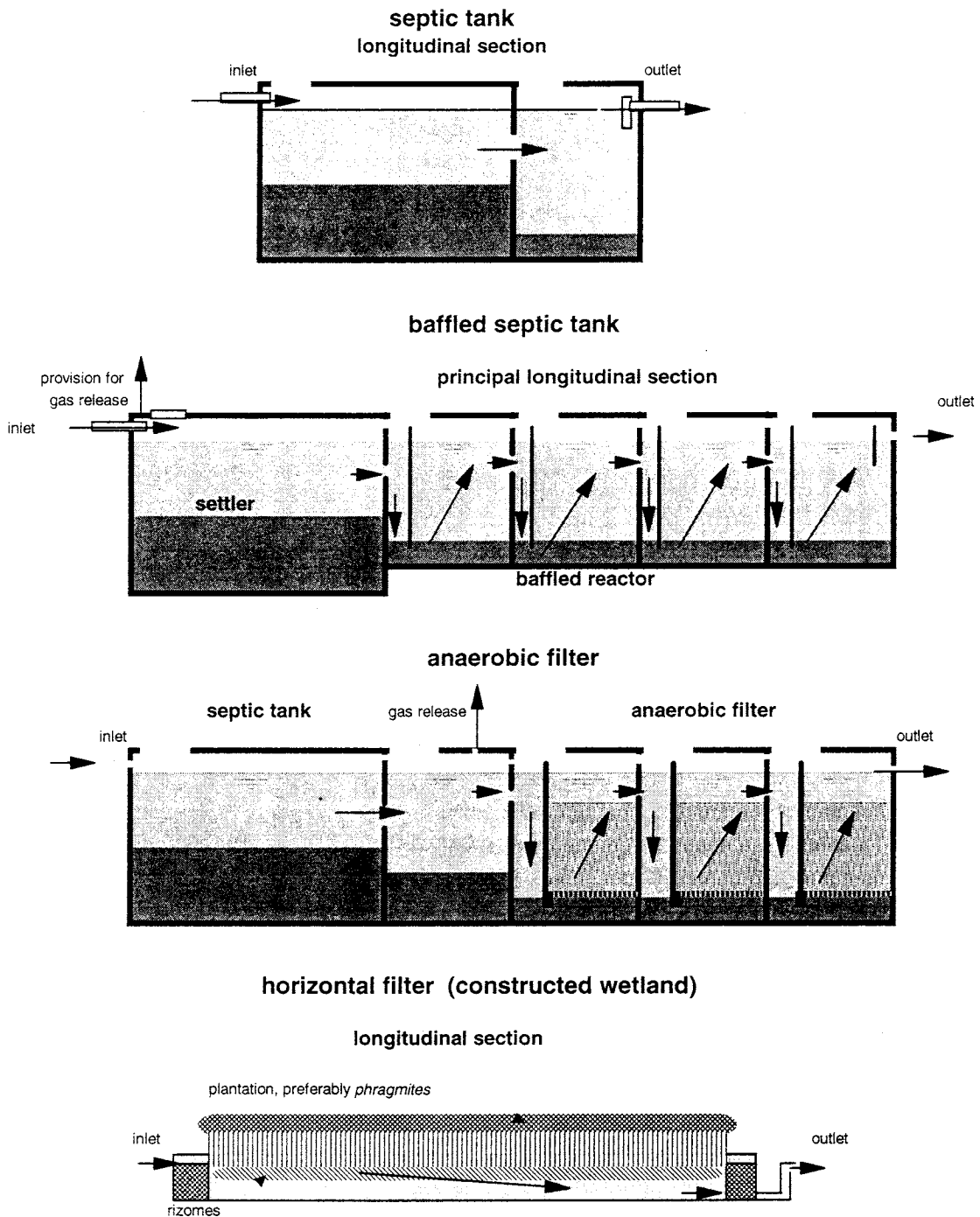

Fig. 2. Treatment systems considered to be suitable for decentralised dissemination

Pros and Cons of DEWATS

type	kind of treatment	used for type of wastewater	advantages	disadvantages
septic tank	sedimentation, sludge stabilisation	wastewater of settleable solids, especially domestic	simple, durable, little space because of being underground	low treatment efficiency, effluent not odourless
Imhoff tank	sedimentation, sludge stabilisation	wastewater of settleable solids, especially domestic	durable, little space because of being underground, odourless effluent	less simple than septic tank, needs very regular desludging
anaerobic filter	anaerobic degradation of suspended and dissolved solids	pre-settled domestic and industrial wastewater of narrow COD/BOD ratio	simple and fairly durable if well constructed and wastewater has been properly pre-treated, high treatment efficiency, little permanent space required because of being underground	costly in construction because of special filter material, blockage of filter possible, effluent smells slightly despite high treatment efficiency
baffled septic tank	anaerobic degradation of suspended and dissolved solids	pre-settled domestic and industrial wastewater of narrow COD/BOD ratio, suitable for strong industrial wastewater	simple and durable, high treatment efficiency, little permanent space required because of being underground, hardly any blockage, relatively cheap compared to anaerobic filter	requires larger space for construction, less efficient with weak wastewater, longer start-up phase than anaerobic filter
horizontal gravel filter	aerobic-facultative-anaerobic degradation of dissolved and fine suspended solids, pathogen removal	suitable for domestic and weak industrial wastewater where settleable solids and most suspended solids already removed by pre-treatment	high treatment efficiency when properly constructed, pleasant landscaping possible, no wastewater above ground, can be cheap in construction if filter material is available at site, no nuisance of odour	high permanent space requirement, costly if right quality of gravel is not available, great knowledge and care required during construction, intensive maintenance and supervision during first 1 - 2 years
anaerobic pond	sedimentation, anaerobic degradation and sludge stabilisation	strong and medium industrial wastewater	simple in construction, flexible in respect to degree of treatment, little maintenance	wastewater pond occupies open land, there is always some odour, can even be stinky, mosquitoes are difficult to control
aerobic pond	aerobic degradation, pathogen removal	weak, mostly pre-treated wastewater from domestic and industrial sources	simple in construction, reliable in performance if properly dimensioned, high pathogen removal rate, can be used to create an almost natural environment, fish farming possible when large in size and low loaded	large permanent space requirement, mosquitoes and odour can become a nuisance if undersized, algae can raise effluent BOD

provides a fresher effluent when de-sludged at designed intervals. The Imhoff tank is used preferably when post-treatment takes

place near residential houses, in open ponds or constructed wetlands of vertical flow type.

Deep anaerobic ponds and shallow polishing ponds are also considered being DEWATS.

Special provisions may have to be made for industrial wastewater before standardised DEWATS designs can be applied. These for example include, an open settler for daily removal of fruit waste from a canning factory, buffer tanks to mix varying flows from a milk processing plant, grease traps or neutralisation pits to balance the pH of the influent. In these cases, standard DEWATS are applicable only after such pre-treatment steps have been taken.

Despite their reliability and impressive treatment performance, such well-known and proven systems as UASB, trickling filter, rotating discs, etc. are not considered as being DEWATS as these systems require careful and skilled attendance.

Most of the treatment processes which are used in large-scale treatment plants despite their proven efficiency do not meet the DEWATS criteria and therefore, cannot be included. The activated sludge process, the fluidised bed reactor, aerated or chemical flocculation and all kinds of controlled recirculation of wastewater are part of this category. Regular or continuous re-circulation is partly acceptable under the condition that the pumps that are used cannot be switched off easily, i.e. separately from transportation pumps.

Well designed conventional treatment plants may not meet DEWATS requirements

Admittedly, this self-imposed restraint over technical choices in DEWATS could in prac-

tice impact upon the quality of the effluent. However, inferior quality need not to be when there is sufficient space for the plant. There are certain measures at hand to discharge effluent of acceptable quality:

- provision of sufficient space at the source of pollution
- pre-treatment at source and post treatment where sufficient land is available
- pre-treatment at source and post treatment in co-operation with others
- accepting an effluent with higher pollution load
- restricting wastewater producing activities at this particular site
- connection to a central treatment plant via sewage line.

Permanent dilution of wastewater or the installation of a mechanised and highly efficient treatment plant remain theoretical options, because experience shows that such processes are chronically afflicted by irregular operation.

2.1.3 Kinds of Wastewater

Septic tanks are used for wastewater with a high percentage of settleable solids, typically for effluent from domestic sources.

Anaerobic filters are used for wastewater with low percentage of suspended solids (e.g. after primary treatment in septic tanks), and narrow COD/BOD ratio; biogas utilisation may be considered in case of BOD concentration > 1.000 mg/l. (BOD = biological oxygen demand, COD = chemical oxygen demand; both are the most common parameters for pollution).

Baffled Septic Tanks are suitable for all kinds of wastewater, however, preferably for such of high percentage of non-settleable suspended solids and narrow COD/BOD ratio.

Constructed wetlands are used for wastewater with low percentage of suspended solids and COD concentration below 500 mg/l.

Wastewater for treatment in aerobic ponds should have a BOD₅ content below 300 mg/l.

Facultative and anaerobic ponds may be charged with strong wastewater, however, bad odour cannot be avoided reliably with high loading rates.

2.1.4 Area requirement

Depending on total volume, which influences tank depth, nature of wastewater and temperature, the following values may indicate permanent area requirement for setting up a treatment plant:

septic tank, Imhoff tank:

0,5 m²/m³ daily flow

anaerobic filter, baffled septic tank:

1 m²/m³ daily flow

constructed wetland:

30 m²/m³ daily flow

anaerobic ponds:

4 m²/m³ daily flow

facultative aerobic ponds:

25 m²/m³ daily flow

These values are approximate figures for wastewater of typical strength, however, the required area increases with strength. There might be no waste of land in case of closed anaerobic systems as they are usually constructed underground. Area for sludge drying beds is not included; this may come to 0,1 - 10 m²/m³ daily flow, according to strength and desludging intervals.

2.2 Performance

2.2.1 Treatment Quality

Treatment quality depends on the nature of influent and temperature, but can basically be defined in the following approximate BOD removal rates:

25 to 50 % for septic tanks and Imhoff tanks

70 to 90 % for anaerobic filters and baffled septic tanks

70 to 95 % for constructed wetland and pond systems.

These values and the required effluent quality decide the choice of treatment systems. For example, septic tanks alone are not suitable to discharge directly into receiving waters, but may suit treatment on land where the groundwater table is low and odour is not likely to be a nuisance. Taking a limit of 50 mg/l BOD being discharged, the anaerobic filter in combination with a septic tank may treat wastewater of 300 mg/l BOD without further post treatment. Stronger wastewater would require a constructed wetland or pond system for final treatment.

There are endless possibilities of cheaper treatment solutions based on local conditions. What is required is that all options be carefully considered. Whether long-way open discharge channels may deliver the required additional treatment should always be taken into consideration. Expert knowledge is needed to evaluate such possibilities; evaluation should compulsorily include analysis of wastewater samples.

Substantial removal of nitrogen requires a mix of aerobic and anaerobic treatment which happens in constructed wetlands and ponds, only. In closed anaerobic tank systems of the DEWATS-type nitrogen forms to

ammonia. The effluent is a good fertiliser, but because of that, causes algae growth in receiving waters and is toxic to fish.

Phosphorus is a good fertiliser, and therefore dangerous in rivers and lakes. Removing of phosphorus in DEWATS is limited, like in most treatment plants. However, constructed wetlands could be helpful when filter media contains iron or aluminium compounds. It should be noted that phosphorus can be accumulated by sedimentation or fixed in bacteria mass, but can hardly be removed or transformed into harmless substances.

2.2.2 Pathogen control

Like all modern wastewater treatment plants, DEWAT systems, as well, are not made for pathogen control in the first place. Pathogen removal rates increase with long retention times, but all high rate plants work proudly on short retention times.

The WHO guidelines and other independent surveys describe transmission of worm infections as the greatest risk in relation to wastewater. Worm eggs, helminths, are well removed from effluent by sedimentation but accumulate in the bottom sludge. The long retention times of 1 to 3 years in septic tanks and anaerobic filters provide sufficient protection against helminths infection in practice. Therefore, frequent sludge removal carries a slightly higher risk.

Bacteria and Virus are destroyed to a great extent, however they remain in infectious concentrations in effluent of anaerobic filters and septic tanks. Nevertheless, the statistical risk of infection is rather limited. High pathogen removal rates are reported

from constructed wetlands and shallow aerobic ponds. This effect is attributed to longer retention times, exposure to UV rays in ponds, and various bio-chemical interactions in constructed wetlands. Pathogen removal rates of these systems are higher than in conventional municipal treatment plants.

Chlorination can be used for pathogen control. Simple devices with automatic dosing may be added before final discharge. However, use of chlorine should be limited to cases of high risk, as it would be for hospitals during an epidemic outbreak. Permanent chlorination should be avoided because it does not only kill pathogens but also other bacteria and protozoans which are responsible for the self purification effect of receiving waters.

2.3 Scope

2.3.1 Reuse of wastewater

Effluent from anaerobic units is characterised by foul smell, even at low BOD values. Irrigation in garden areas should then better be underground. Effluent from aerobic ponds or constructed wetlands is suitable for surface irrigation, even in domestic gardens. However, the better the treatment effect of the system, the lower is the fertilising value of the effluent.

Although most pathogens are removed in aerobic ponds, domestic or agricultural effluent can never be labelled "guaranteed free of pathogens". Irrigation of crops should therefore stop 2 weeks prior to harvesting. It is best not to irrigate vegetables and fruits, which are usually consumed raw after flowering.

Treated wastewater can be used for fish farming when diluted with fresh river water or after extensive treatment in pond systems. Integrated fish and crop farming is possible.

2.3.2 Reuse of Sludge

Each treatment system produces sludge which must be removed in regular intervals, which may reach from some days or weeks (Imhoff tanks) to several years (ponds). Aerobic systems produce more sludge than anaerobic systems. Desludging should comply with agricultural requirements because sludge although contaminated by pathogens is a valuable fertiliser. Consequently sludge requires careful handling. The process of composting kills most helminths, bacteria and viruses due to the high temperature that it generates.

2.3.3 Use of Biogas

Conventionally, DEWATS do not utilise the biogas from anaerobic processes because of the cost and additional attendance factors. Devices for collection, storage, distribution and utilisation of biogas add to the cost to be recovered from the energy value of biogas. However, under certain circumstances the use of biogas may actually reduce the cost of treatment. Biogas utilisation makes economic sense in the case of strong wastewater, and especially when biogas can be regularly and purposefully used on-site. Approximately 200 litres of biogas can be recovered from 1 kg of COD removed. A household normally requires 2 to 3 m³ of biogas per day for cooking. Thus, biogas from 20 m³ of wastewater

with a COD concentration of not less than 1000 mg/l would be needed to serve the requirements of one household kitchen.

2.3.4 Costs

Total costs, described as annual costs, include planning and supervision costs, running costs, capital costs, and the cost of construction inclusive of the cost of land. As is evident, it is not easy to provide handy calculations on the total cost of wastewater treatment. The comparison of costs is also made difficult, by the fact while a particular system may be cheaper it may not necessarily be the most suitable, while other systems might be expensive at one location but cheaper at another due to differential land prices. However, in general it can be confidently said that DEWATS has the potential of being more economical in comparison to other realistic treatment options. This is true on account of the following:

- DEWATS may be standardised for certain customer-sectors, which reduces planning cost.
- DEWATS does use neither movable parts nor energy, which avoids expensive but quickly wearing engineering parts.
- DEWATS is designed to be constructed with local craftsmen; this allows to employ less costly contractors which causes lower capital cost, as well, and later lesser expenses for repair.
- DEWATS may be combined with natural or already existing treatment facilities so that the most appropriate solution may be chosen.

- DEWATS has the least possible maintenance requirements which spares not only manpower for daily attendance but also highly paid supervisors or plant managers.

No wastewater treatment is profitable in itself. However, the indirect gains from treating wastewater might be numerous. Whether decentralised DEWATS can compete with the fees and creature comforts that people derive from of a centralised sewer connection would depend on the local situation. The feasibility of using treated water, sludge or biogas also differs from place to place. Integrated wastewater farming merits consideration albeit as a completely independent business.

2.4 Implementation

2.4.1 Designing Procedure

If the planning engineer knows his craft and recognises his limitations, designing DEWATS is relatively simple. Performance of treatment systems cannot be precisely predicted and therefore calculation of dimensions should not follow ambiguous procedures. In case of small and medium scale DEWATS, a slightly oversized plant volume would add to operational safety.

Based on local conditions, needs and preferences plants of varying sizes could be chosen to become fixed standard designs. On-site adaptation can then be made by less qualified site supervisors or technicians.

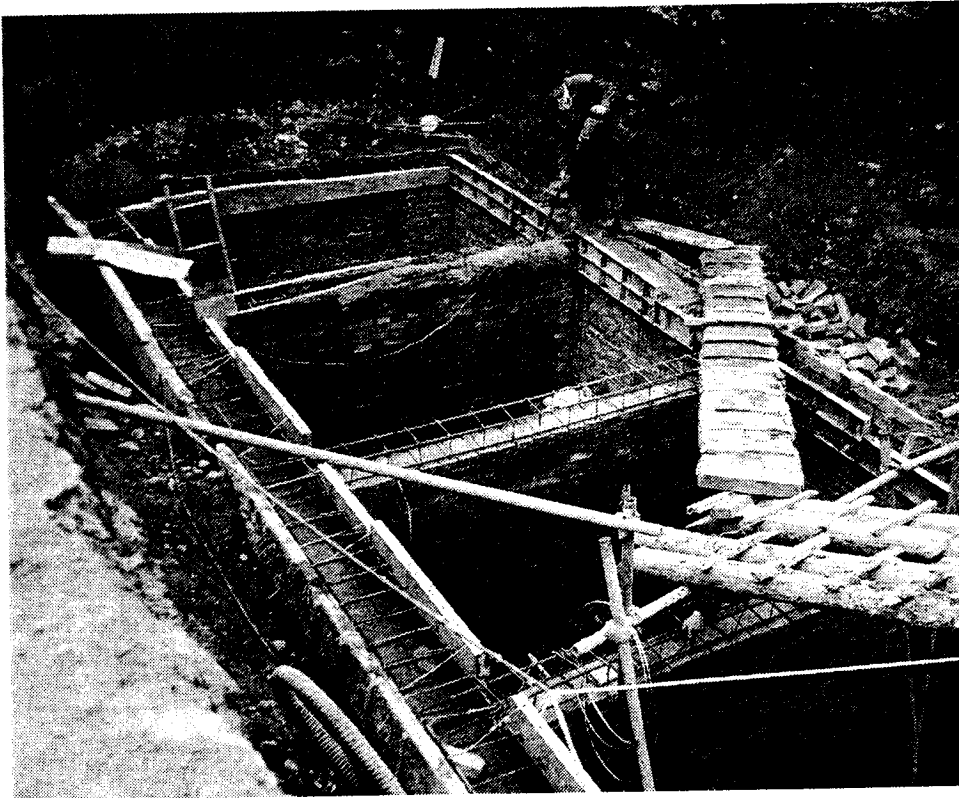

Individual cases have to be calculated and designed individually; the structural details of the standard plants may be integrated. A simplified, quasi standardised method has been developed for calculation of dimensions (see chapter 13.1).

Co-operative plant systems that require interconnecting sewerage must be designed individually by an ex-

Fig. 3.
DEWATS anaerobic filter under construction. Planning and supervision by CEEIC [photo: Sasse]

perienced engineer who is able to place plants and sewers according to contours and other site requirements.

2.4.2 Wastewater Data

Data indispensable to the calculation and choice of the right DEWATS design are:

- daily wastewater flow
- hours of major wastewater flow or other data describing fluctuations
- average COD values and range of fluctuation
- average BOD values or average COD/BOD ratio
- suspended solids content, percentage of settleable solids
- pH
- ambient temperature and temperature of wastewater at source

In the case of domestic wastewater this data is easy to arrive at when the number of persons and water consumption per capita per day is known. While total water consumption might be easy to measure on site, it is important to consider the amount of water only that enters the treatment system.

For industrial wastewater other parameters such as COD/N or COD/P relation, content of fat and grease, content of toxic substances or salinity are also likely to be of concern. A full analysis may be necessary when planning the first such plant. Comprehensive understanding of the production process of the industry will help to specify crucial information required. Customarily production processes are unlikely

to differ vastly within a defined area of production, thereby making standardisation fairly easy.

2.4.3 Construction

DEWATS are relatively simple structures that can be built by reasonably qualified craftsmen or building contractors with the ability to read technical drawings. If this were not the case, almost daily supervision by a qualified technician would be required. The construction of watertight tanks and tank connections would require craftsmanship of a relatively high order. Control of construction quality is of utmost importance if biogas is to be stored within the reactor.

Technical details of a design, which has been adapted to local conditions, should be based on the material that is locally available and the costs of such material.

Important materials are:

- concrete for basement and foundation
- brickwork or concrete blocks for walls
- water pipes of 3", 4" and 6" in diameter
- filter material for anaerobic filters, such as cinder, rock chipping, or specially made plastic products
- properly sized filter material for gravel filters (uniform grain size)
- plastic foils for bottom sealing of filters and ponds

Gate valves of 6" and 4" diameter are necessary to facilitate de-sludging of tanks regularly.

2.4.4 Maintenance

The more a standard design has been adapted or modified to fit local conditions, the greater the likelihood of operational modification during the initial phase. It is therefore important that the contractor or design engineer keeps a close eye on the plant, until the expected treatment results have been achieved. Despite faultless implementation, it may be necessary to extend such attendance up to as long as two years.

Permanent wastewater treatment that does not include some degree of maintenance is inconceivable. DEWATS nonetheless reduces maintenance to the nature of occasional routine work. Anaerobic tanks would need to be de-sludged at calculated intervals (usually 1 to 3 years) due to the sludge storage volume having been limited to these intervals. Treatment is not interrupted during de-sludging. Normally, sludge is drawn from anaerobic digesters with the help of portable sludge pumps, which discharge into movable tankers. Direct discharge into adjacent sludge drying beds may be possible in the case of Imhoff tanks with short de-sludging intervals.

Anaerobic filters tend to clog when fed with high pollution loads, especially when of high SS content. Flushing off the biological film is possible by back washing. This will require an additional outlet pipe at the inlet side. In practice, what is usually done is to remove the filter media, wash it and clean it outside and put it back after this cleaning. This may be necessary every five to ten years.

Constructed wetlands gradually lose their treatment efficiency after 5 to 15 years, depending on grain size and organic load.

The filter media would need to be replaced. The same media may however be re-used after washing. During this exercise unless several filter beds were to be provided, treatment would have to be suspended. Surface plantation has then to be replaced also; otherwise regular harvesting of cover plants is not required.

Pond systems require the least maintenance. De-sludging may not be necessary for 10 to 20 years. Normally, an occasional control of the inlet and outlet structures should be sufficient. Control of wastewater flow may be required when a foul smell occurs due to overloading in the hot season. Such problems can be avoided through intelligent inflow distribution and generous sizing of ponds.

2.4.5 Training for Operation

DEWATS is designed such that maintenance is reduced to the minimum. Daily attendance is limited to certain industrial plants. However, there should be someone on-site who understands the system. It would be best to explain the treatment process to the most senior person available, as he is likely to be the one to give orders to the workers in case of need. In case the educational qualifications of the on site staff is low, the engineer who designed the plant or the contractor who constructed the plant should provide service personnel, who may come to the site once a year or at times of need.

Extensive training of staff at the lower level is generally not necessary and in most cases not effective due to fluctuation of workers. Hiring professional manpower for after care service may then be considered the better

solution. The case might be different for hospitals or housing colonies that usually have a permanent staff.

If a large number of DEWATS are to be implemented the aim should be to standardise the maintenance service. This is likely to be possible because of local standardisation of plant design, with similar characteristics for operation.

3 DISSEMINATION

3.1 The Need for Active Dissemination of DEWATS

Planning and implementation of DEWATS is not a very profitable business for engineers and building contractors. Therefore, dissemination of decentralised wastewater treatment systems will need to be pushed by political will and administrative support.

The treatment units are relatively small, nevertheless complicated and are usually spread over a scattered area. The required expertise for their realisation is truly remarkable. Resultantly, general planning must be centralised and designing standardised in order to reduce the overall cost per plant and to maintain the required expertise. On the other hand, any centralisation will involve the setting up of a superstructure with its build-in tendency to create an expensive officer's pyramid. To achieve implementation of a large number of plants, a strong and omnipresent superstructure seems to be required. The dog bites in his own tail. However, this superstructure becomes relatively less expensive if the scale of implementation is large. Therefore, a reasonable, affordable and sustainable dissemination strategy is essential to balance the desired environmental benefits with acceptable social costs. Short-term economic viability of the superstructure cannot necessarily be the yardstick for choosing a dissemination strategy.

3.2 Preconditions for Dissemination

There are some preconditions commonly required for dissemination of any decen-

tralised technology or technical hardware. These preconditions have to be fulfilled before one may start thinking about a dissemination strategy:

- The hardware to be disseminated is technically sound
- In principle it is feasible to operate and maintain the hardware on the spot.
- The technology in general is economically and/or environmentally useful.
- The technology is suitable and useful in the particular local situation.

Dissemination would make sense only if these pre-conditions are fulfilled.

There will be no improved wastewater treatment without technical expertise

DEWATS, as a decentralised technology will always need local adaptation. Even fully standardised designs are constructed locally; for example, they have to be connected to the source of pollution and have to be set at proper level to allow free flow of effluent to the receiving water. Implicit in the decentralisation of technology is the decentralisation of know-how and expertise. Centralised guidance and supervision of decentralised activities is extremely costly. These services would therefore have to be kept to the minimum. This would be possible, only if basic knowledge and a minimum of expertise were locally available.

Local adaptation of DEWATS is influenced by:

- the technical requirements and solutions,
- the geographical or physical environment and
- the social and socio-economic circumstances.

On the other hand, dissemination has to choose a strategy which observes several aspects:

- the social aspect,
- the economic aspect,
- the technical aspect and
- the legal aspect

The dissemination strategy that is ultimately chosen has to include all these aspects.

3.3 The Social Aspect

3.3.1 The Status of Waste Disposal in Society

The public is growing in its awareness of wastewater treatment as a result of increasing damage and pollution to the environment from wastewater. However, public interest appears to be confined to the harmful effects of pollution, only. In other words, there is no particular public interest in having a wastewater treatment plant - and there appears to be definitely even less interest in maintaining it. The general attitude is one of "somebody must do something".

The public needs to realise that that "somebody" is they, if nobody else really cares about their problem. The question then is with regard to the preferred treatment con-

cept. It is unlikely that individual DEWATS which must be taken care of by the individual will be very popular. Even if DEWATS were to be the only possibility, public willingness to participate in the programme would still be limited. Therefore, concepts, which require the participation of the general public, are not likely to work too well, and consequently should be avoided whenever possible.

Throughout the ages anything related to wastewater seems to have had very low priority. Even in olden times it was always people of the lowest social status who were put in charge of waste disposal. Unlike carpenters, masons or other professionals, these "scavengers" as they were called were never really interested in upgrading their discriminated skills. Understandably, the knowledge of wastewater disposal lagged behind other basic civic techniques. Strangely that missing interest was found even among royalty whose otherwise impressive castles had all but a primitive toilet outside. The well-designed and elaborate place of Versailles for instance, did not have a toilet. Similarly, the genius engineer Leonardo da Vinci developed weapons, bridges, air planes; but in his model city of 1484, treatment of waste was relegated to just one low-level wastewater canal.

Wastewater engineers are probably the only ones who love handling wastewater

Nonetheless, the taboo on faeces that exists over centuries is perhaps the most efficient sanitary measure, and still is from a health point of view a beneficial habit. However, the phenomenal population growth

the world over has increasingly demanded professional attention to wastewater and its disposal in response to which, today we have a new breed of wastewater engineers who are not ashamed of their profession.

3.3.2 Organising People

For wastewater treatment to take place in a co-operative context, it is important that people are organised. The objectives of organising people may be manifold:

- collecting investment capital,
- contributing land,
- giving permission for trespassing of sewers over private land,
- collective operation and maintenance
- collective financing of services for operation,
- use of effluent for irrigation, sludge for fertiliser or biogas for energy.

There are numerous ways in which people can come together. The framework of action may be the general community administration, a development project, or an NGO, which supports self-help activity. However, the local tradition of self organisation and co-operation and the particular image of the subject "wastewater" will influence the organisational structure.

How to organise people is a well-researched subject. The results and suggestions of all those books and concepts cannot be presented here in detail. However, great care is necessary to check any proposed method whether it is suitable and promising in case of wastewater treatment and disposal. Most experiences of community involvement in

sanitation are related to water supply or low cost toilet programmes for individual households, programmes which meet immediate felt needs. It must be remembered that this is not so with wastewater disposal - and even less so with wastewater treatment. People do not want to be bothered with it. In general, people expect that anonymous authorities should take care of this problem. Public willingness to get involved in treating their wastewater is low and can only be expected to increase in case of severe crises, or in the likelihood of substantial economic benefit as in the case of re-using wastewater for irrigation, for instance.

3.3.3 Partners for Dissemination

The logical partners in dissemination of wastewater treatment systems beside the polluter as customer, are the government administration at one end, and private enterprise such as engineering companies, at the other. In an ideal scenario, the government would announce a set of by-laws and then oversee the implementation of these bylaws. Thereupon, polluters by social agreement or threat of punishment would be obliged to contact private engineers and contractors to implement an adequate treatment and disposal system. The investment capital would come from the individual, from bank loans, and perhaps as a subsidy from public funds. This scenario is typical to industrialised countries.

In developing countries, the scenario might appear deceptively similar. On the contrary, the comparison is not likely to go beyond the introduction of bylaws, which are seldom enforced, as a result of which pollut-

ers may not even be aware of their existence. The service of private engineers is also likely to be far too expensive for the small polluter. Altogether, this leads to a situation of complete in-action or to one of arbitrary abuse of power by some officials. As a result of the failure of the government or the private sector, informal or registered self-help groups step in to carry out the various tasks that are normally not theirs.

Public awareness towards the problem of wastewater pollution has grown tremendously in recent years. Politicians and government administrations welcome any initiative to help solving the problem through decentralised measures. Money is often not the biggest problem, at least for pilot or demonstration projects. However, there is a general helplessness when it comes to individual implementation, and more so when it comes to active and well organised dissemination of DEWATS.

Tab. 1.
Indian discharge standards

Indian National Discharge Standards					
parameter	unit	discharge into			
		inland surface water	public sewers	land for irrigation	marine coastal area
SS	mg/l	100	600	200	100
pH		5.5 to 9	5.5 to 9	5.5 to 9	5.5 to 9
temperature	°C	< +5°C			< +5°C
BOD ₅	mg/l	30	350	100	100
COD	mg/l	250			250
oil and grease	mg/l	10	20	10	20
total res. chlorine	mg/l	1			21
NH ₃ -N	mg/l	50	50		50
N _{kjel} as NH ₃	mg/l	100			100
free ammonia as NH ₃	mg/l	5			5
nitrate N	mg/l	10			20
diss. phosphates as P	mg/l	5			
sulphides as S	mg/l	2			5

CPCB

Marketing experts, development consultants or socially oriented NGOs are the first to present themselves as partners for dissemination. Other business organisations and contractors more suited to wide scale dissemination are rare 'diamonds in a heap of sand'. The logical consequence of this dilemma is to find new local partners for decentralised dissemination at each place. Since these partners will play the key role in implementation, dissemination concepts must necessarily be shaped to suit them.

Dissemination concepts must suit the local partners

3.4 The Economic Aspect

3.4.1 Decentralisation

Whether decentralised wastewater treatment is better than centralised treatment is basically a question for theoretical or ideological discussion. In practice, there is always likely to be a mix of centralised and decentralised solutions.

Cost-benefit analyses are helpful as general policy considerations and for choosing the most economic treatment system in individual cases. However, the problem of a cost-benefit analysis of DEWATS lies in the parameters influencing the calculation, which are often difficult to project a priori. A time frame of 20 to 30 years - the normal lifetime of a treatment plant - should constitute the basis for calculation. While construction costs are relatively

easy to calculate, an estimate of realistic running costs would need an in-depth study of the technical requirements of the system as well as the prevailing social environment.

Further, it would need a fairly precise reading into future management structures. Overheads in form of salaries for the management, expenditure for the logistic requirements of operation and maintenance are extremely difficult to foresee, especially in the case of co-operatives. The cost of transporting sludge, for example, can increase manifold if the neighbouring farmer decides not to take the sludge. A new drying or dumping place could be so far away so that trucks would have to be hired instead of oxcarts as planned, sending calculations awry.

A **totally centralised system** would result in the lowest plant construction cost per treated volume of wastewater. On the other hand, connecting individual sources to the treatment unit may result in up to five times the cost for the required sewerage. Management costs are comparatively low because one highly qualified manager cares for a large volume of wastewater, respectively a large number of users. Maintenance costs are quite high, instead, because sophisticated mechanised equipment requires permanent care.

A **semi-centralised system** connects several smaller treatment units to sewerage of shorter overall-length. Construction costs are relatively low, but qualified management may be needed for each plant, thus pushing up the cost.

A **fully decentralised system** would need a natural environment that is capable of absorbing the discharged wastewater of each

individual plant on-site. Structural costs are likely to be the lowest for fully decentralised systems, especially if slightly sub-standard treatment is accepted. Safe sludge disposal must also be possible at site, otherwise the cost of transportation for sludge collection and disposal must be included. Maintenance and management costs are dispensed with when the user of the plant also attends to it. However, if proper operation on a more sophisticated level is to be secured, the need for qualified supervision and service structures may arise, which to a certain extent would need to be organised centrally (for example for collection and disposal of sludge). Regular effluent control is particularly costly in decentralised systems.

3.4.2 Treatment Quality

The kind of environmental pollution that exists tends to justify the strict discharge standards that prevail. However, standards that are extremely high, paradoxically may worsen, not improve the situation.

The nature of treatment is first of all a function of the area, for which one may allow a certain degree of environmental pollution. If the area where pollution occurs is infinite, there may be no necessity for treatment. Similarly, when pollution is infinitely small the polluted area is zero. Situations between these two extremes should be open for setting priorities, meaning that the final choice should be open to negotiation. Economic, social and environmental aspects would each merit due consideration to reach the most acceptable compromise with regard to the required treatment quality.

Permitted discharge quality will also depend on the location of pollution. Transport of wastewater to sites further away instead of on-site treatment had been practised since man developed settlements. Today, wastewater transportation to remote land or waters is still common. While this may be acceptable today, the damage to the environment may become irreversible and in time, the legacy of pollution could hit back at the polluter. In the case of DEWATS dissemination, the decision to treat wastewater on-site and not just send it away is already made.

In most countries national pollution standards allow for higher pollution loads in effluents of smaller plants, and effluent standards are "softer" when the discharge is onto land and into waters that are little used.

Discharge standards in developing countries have often been borrowed from industrialised countries, which are based on highly diluted municipal sewage. DEWATS in developing countries are meant for public toilets, hospitals, schools or smaller communities where it is likely that lesser water is used for household and toilet purposes than in industrialised countries. The high concentration of wastewater from water saving toilets leads automatically to higher BOD concentration of the effluent, even when BOD removal rates are within the technical range of an adequate treatment system. In such case, as saving of water is crucial to sustainable development it would not be reasonable to dilute the effluent "artificially" in order to achieve an administratively imposed concentration. Standards which relate to absolute pollution loads (instead of concentrations) would be more reasonable, at least for small units.

This point is especially important, because one of the great advantages of decentralisation and on-site treatment is that waste transport in short sewer pipes does not require highly diluted wastewater. Despite higher concentrations, the absolute pollution load remains the same. Water saving policies could easily accept higher concentrations at the outlet when other environmental factors being favourable; for example when there is enough land available or the receiving river carries enough water the year round.

Furthermore, it makes little sense to install DEWATS of a high treatment quality, when their effluent joins an open sewer channel which receives other untreated wastewater. In this case, simple, individual septic tanks, which cost less but are albeit less effective in their performance, would be appropriate, because treatment of the main wastewater stream would in any case have to be done.

3.4.3 Treatment Cost

Thirty to fifty percent of the pollution load may be removed with simple technology, such as the septic tank. Another thirty to forty percent might be removed with the help of units such as baffled septic tanks and anaerobic filters that are yet simple but far more effective. Any further treatment would require post treatment in ponds or constructed wetlands (conventional systems using artificial oxidation do not belong to the DEWATS family). The higher the relative pollution removal rate, the higher are the absolute treatment costs per kg BOD removed. Additional treatment devices for removal of nitrogen, phosphorous or other

toxic substances are likely to be unusually expensive.

Technically spoken, DEWATS are able to meet any discharge standard. However, since self sustainable dissemination of DEWATS is likely to be strongly influenced by investment and operational costs, the choice of an appropriate treatment standard will not only determine the dissemination strategy but may be vital for the total success of DEWATS.

Treatment efficiency of DEWATS may be as high as that of any conventional treatment plant

Environmental experts and experienced wastewater engineers would need to determine appropriate treatment standards. It is crucial that authorities that administrate pollution control have a understanding of the issue and can be flexible in accepting and legalising deviations from general standards, so long as these deviations are ecologically acceptable.

3.4.4 Investment Capital

As there is generally no financial return on wastewater treatment there is little genuine economic interest to invest in it. Apart from the few persons who act out of a sense of responsibility for the environment, there is rarely anybody who invests in wastewater treatment voluntarily. Only if and until polluters are compelled by law to pay for the pollution they cause will investment capital become available to wastewater treatment, because investment in wastewater treatment will be viable compared to imposed fines.

Construction budgets for new buildings and enterprises are likely to include wastewater treatment costs. Existing units, apart from the problem of having the space for construction may not be able to raise funds for installing a treatment unit at one time. Dissemination programmes must therefore necessarily ensure the availability of credit schemes to polluter's for wastewater treatment.

A sustainable dissemination strategy must take into account the time it may take a polluter to allocate the required capital (for example, to wait until the next board meeting decides on the matter). Practically this could translate into a time lag of a year or more between the time when the planning engineer invites the contractor to see the site and make a realistic estimate for construction and the availability of funds for the purpose. Besides the inflation factor this also implies that a contractor cannot afford to rely solely on DEWATS for his survival. Under these circumstances it may be difficult to recruit contractors who are permanently available to a DEWATS dissemination programme.

3.5 The Technical Aspect

3.5.1 Decentralisation

From an economic point of view, decentralisation requires a simplified technology for the reason that it will be prohibitively expensive to permanently maintain the necessary expertise for sophisticated technology on a decentralised level.

It may be possible to actualise decentralised solutions with the help of completely standardised designs based on local con-

struction techniques; in other words, by placing "black-box" hardware packages on the "market". In both cases expertise will be needed for choosing the right design or the suitable "black-box". Expertise will also be needed to advise the user in proper operation and adequate maintenance. Such advice must have a stable address, which might be difficult in case certain operations become necessary after one or two years only, for example in the case of de-sludging. This could also mean that the constructing enterprise would need to be contracted for maintenance and operation on behalf of the customer. The expertise available for on-site operation and maintenance would decide on the nature of required plant management.

Invaluable experience gained from rural biogas dissemination programmes over a span of 30 years in India, China and several other countries confirms that each such project or programme had first to develop an appropriate local design notwithstanding the availability of standardised designs from other projects /countries. Interestingly neither India nor China have been able to sustain the dissemination of their small-scale rural biogas programme from a technical point of view without the support of a superstructure. In most cases it has been difficult to ensure that the user has sufficient expertise to maintain the biogas plants properly. None of the programmes have been able to do without a subsidised after sales service. This scenario is bound to be true to other areas of technology dissemination as well.

DEWATS is far more complicated than rural biogas plants. The bio-chemical and physical properties of wastewater especially in case of wastewater from industrial sources

are far from uniform. Consequently, the expertise required for design, construction and operation of DEWATS become all the more indispensable as compared to rural biogas plants. One of the crucial points is to decide whether a standard design is suitable, or how it should be modified.

The availability of the right expertise is irreplaceable in DEWATS dissemination. It is decisive for a dissemination programme of decentralised plants to clarify the nature of the expertise that is to be maintained, at what level and for which technology. Missing knowledge and expertise cannot be consigned to the insignificance of a so-called "social matter". Professionals and technicians are duty bound to ensure that the goods or structures they provide are technically sound and appropriate. The breakdown of a technical system is not necessarily the fault of the customer. It is the duty of the technician to deliver the right design for a given situation.

It is the duty of the technician to deliver an appropriate design which will be realised with an appropriate technology

A division of labour between different experts is essential. It is the duty of the non-technical "social" staff to feed the technician with information about social matters and the technician to feed the social experts with information about the technical necessities. What is required is collaboration between the disciplines, not role confusion. It is a known fact that technicians as a rule do not give enough information about technical necessities to social experts. This in all likelihood happens for two rea-

sons: the technicians do not know the technology well enough and/or the social experts are not able to understand the implications of the technical requirements. The problem of sub-standard technical knowledge is likely to be true of most potential DEWATS constructors - and promoters.

3.5.2 Construction

The local availability of hardware is a precondition for decentralisation. In case of main structures, appropriateness of local building material plays a decisive role in executing the construction. The kind of filter material available for instance influences the choice of the treatment principle. Expertise is needed to modify standard designs, or if necessary, make new designs, which can be constructed with locally available material. It is also important to decide whether traditional construction techniques are suitable for wastewater treatment systems, especially if biogas is supposed to be used. The expert has also to decide whether the treatment system fits the local geography.

At the level of implementation of small-scale treatment systems, the qualification of craftsmen is usually low. Masons may not be able to read and write and thus, structural drawings are not useful at site. Structural designs would therefore have to be simplified or supervisors who are properly qualified to read the drawing be present regularly.

Familiarity with the design principles apart, a mastery of structural details will be crucial to the proper functioning of the plant. The need for correct execution of the structural details of the design cannot be over-emphasised. Cost or efficiency enhancing modifications of structural details is ill

advised in the absence of a deep understanding of the proposed measure. For example, a dentated sill is of no use if the top of teeth, instead of the bottom notches, is kept in level.

3.5.3 Substrate

The quality, quantity and other properties of wastewater determine the treatment principle from a scientific point of view. The type of treatment system finally chosen will depend on the geographical, structural and socio-economic conditions. Expertise to analyse and evaluate the wastewater, to choose the most appropriate treatment system and to countercheck the design in respect to its local suitability will be imperative.

In the absence of such expertise at the local level, standardisation on the basis of similar wastewater in the region will be the next step. The local expert should then at least be able to distinguish between "standard" and "other" wastewater. To do this, there must be somebody in the disseminating organisation that can read laboratory results or, at least understands the importance of working with the right data in choosing the appropriate structure. Furthermore, someone would be required to collect representative wastewater samples and interpret the laboratory results for the technician.

Low maintenance is demanded of decentralised wastewater treatment. If structural measures can improve treatment, chemicals such as coagulants are „forbidden“. However, the use of chemicals may be unavoidable if bacterial growth is impaired by nutrient deficiencies, e.g. an unbalanced phos-

phorous-nitrogen ratio. Bio-chemical expertise is required to decide if such measures are really necessary.

3.6 The Legal Aspect

3.6.1 The Political Environment

The over all political climate is as important as the administrative framework. It is important to know who the movers are and the different roles each actor plays. It is also important to be familiar with the regulatory framework and more specifically the extent to which rules and regulations are actually enforced. To politicians, inefficiencies of the legal framework are at worst a moral matter, only, whereas to those implementing a DEWATS dissemination strategy, inefficiencies of the socio-political environment are essentially a fundamental planning parameter.

Conventionally, policy is formulated on a bedrock of relevant facts. Familiarity with scientific or technical facts ensure that the right policy and the right laws and by-laws are shaped. Decision-makers should know that each step in the treatment process removes only a portion of the incoming pollution load. It is also important that they know that DEWATS is premised on the belief that wastewater treatment should be permanent and that permanency can only be guaranteed by simple and robust systems. This implies that permanent wastewater treatment is not possible without maintenance. Nonetheless, in DEWATS, maintenance operations are kept to the absolute minimum - necessarily.

3.6.2 Political Priorities

Political and administrative preferences lean heavily towards large scale, centralised wastewater and sewerage systems. Given the fact that most wastewater is produced by urban agglomerations, this is understandable. Domestic wastewater from towns and cities is the largest single source of water pollution. Industrial wastewater from suburban areas comes next. In India it has been estimated that only 50% of the wastewater that finally reaches the river Ganges actually passes through urban wastewater treatment plants. The other 50% of this water flows untreated into the environment. Whether this untreated 50% can be actualised into a potential demand for DEWATS depends on policy making and the seriousness of its application.

Most governments tend to sacrifice environmental concerns on the altar of fiscal demand. The industrialised west has been no different. The history of wastewater treatment in Europe and North America reflects the tug of war between the economy and the environment. Earlier and today, the state-of-the-art of treatment technologies and regulatory framework is the outcome of this dialectic.

The same seems to be happening in developing countries as well, the only difference being in the import of advanced treatment technologies from industrialised countries. Today environmental standards, i.e. discharge standards for wastewater are being based on the treatment technologies that are available, and not on the prevailing state of the economy. This is leading to a strange situation wherein the strict discharge standards are hardly followed because their application is too expensive. Thus, the indi-

vidual polluter gets away by completely ignoring the problem or by setting up a fake treatment system to please the environmental control officer. Either way, the environment is not protected. On the other hand, were environmental standards to be more realistic and feasible there is greater likelihood of adherence to the law by individual polluters.

“Undue haste in adopting standards which are currently too high can lead to the use of inappropriate technology in pursuit of unattainable or unaffordable objectives and, in doing so, produces an unsustainable system. There is a great danger in setting standards and then ignoring them. It is often better to set appropriate and affordable standards and to have a phased approach to improving the standards as and when affordable. In addition, such an approach permits the country the opportunity to develop its own standards and gives adequate time to implement a suitable regulatory framework and to develop the institutional capacity necessary for enforcement.”

(Johnson and Horan: *“Institutional Developments, Standards and River Quality, WST, Vol 33, No 3, 1996”*)

It is also important to apply a law in keeping with its original intention. But this is only possible if the technology is fully understood. It is interesting to know that England at the end of the last century considered case by case assessment of individual polluters but abandoned the proposition fearing administrative snarls and an untenable relaxation of discharge standards. In the current scenario when decentralised wastewater treatment is being taken far more seriously than in the past, such an approach may still be advisable. In the case of pond treatment *Duncan Mara* gives an example:

“If filtered BOD was permissible then a one-day anaerobic pond plus a 4-day facultative pond could reduce the BOD from 300 to 30 mg/l filtered, but to

only 60mg/l unfiltered; two 3-day maturation ponds would be needed to get the BOD down to a 30 mg/l unfiltered - equal to an increase in retention time of 120%! So the filtered, unfiltered question has major cost implications. Those who might worry about the effect of pond algae in a receiving watercourse should remember that they will produce oxygen during the day but, more importantly, they will be quickly consumed by the stream biota,... So maturation ponds are not always required.”

(*D. Mara, “Appropriate Response” in WQI May/June 1997*).

Another obstacle to achieving a better degree of treatment are unrealistic and overly ambitious master plans that could never be successfully implemented in the given time and resource frame; whereas more modest, intermediate solutions would be more likely to succeed. In all fast growing towns and cities, municipal boundaries have been over run by rapidly expanding urban agglomeration; a fact, that is perhaps not even reflected in the master plan. On the other hand, an over extended master plan could be well beyond the financial and logistical strength of the municipality. A more general solution, that includes appropriate decentralised treatment systems could improve the environment considerably, although this measure would have to bear the label of being only “temporary” („temporary“ like slums, which by practice became „permanent“).

3.6.3 Legal Aspects of Some Sectors of DEWATS Application

3.6.3.1 Human Settlements

Administrative support to disseminate DEWATS must distinguish between low-income areas, middle class housing colonies and high income “enclaves”. A pragmatic

approach would be to pass a "temporary" by-law (or short-term master plan) for a specific area, which reflects both, the economic as well as the environmental situation. Making the ultimate degree of treatment the yardstick does not work. A more realistic benchmark ought to take into account the capacity of the administration - financial and logistical - to enforce the feasible standards of those "temporary" by-laws. Since local conditions vary from site to site, the prescription of absolute measures would be self-defeating were administrative guidelines would be more befitting. Such guidelines should take into account:

- Items which can immediately be considered, e.g. treatment systems which can be implemented by the individual polluter or the respective group of polluters at the time of constructing the buildings.
- Items which will remain valid into the future, and will not conflict with future master-plans.
- True temporary items which may have a shorter life time or lower performance than "everlasting" structures.

The key purpose behind temporary by-laws would be to prescribe, rather dictate a set of DEWATS measures, than to set standards of discharge quality which have to be controlled. Durable, anaerobic rough treatment systems such as baffled septic tanks or anaerobic filters may be most suitable in such cases. Smaller sewage diameters could later be used if these pre-treatment systems are kept permanently in operation. A centralised maintenance service or control over a decentralised service would be needed to guarantee that the system works.

In case of high-income enclaves, individual post treatment with planted gravel filters would be appropriate when receiving waters are not located too far away. Otherwise, post-treatment is preferably done in semi-centralised units, e.g. ponds, which might be cheaper to construct and operate. Sewage lines cannot be avoided in that case.

3.6.3.2 Hospitals, Schools, Compounds, Army Camps, Hotels, etc.

An institution could sometimes be the only substantial polluter in an otherwise clean and healthy rural environment. In such a case, permanent on-site wastewater treatment is the only solution.

The best approach to achieving the highest degree of environmental protection would be to let realistic assessment of possible treatment methods guide administrative control. The potential of the most appropriate DEWATS should be the basis for setting discharge standards and for dictating compulsory treatment units. Durability and permanence should rule over the tendency to set the highest theoretical standards of treatment performance.

In the case of new installations, only options which fulfil DEWATS criteria stand a chance of providing permanent and viable service. Systems using artificial oxidation technologies should not be permitted, since the system can be switched off without negative impact on the polluter himself. The pollution control authorities have to propose DEWATS if the polluter or his planning architect is not familiar with that option. It should not be difficult to enforce the necessary by-laws, since DEWATS is probably the most economic alternative.

3.6.3.3 Industrial Estates

Industrial estates are a conglomeration of enterprises that produce wastewater of varying volume and strength. A common treatment plant for the whole estate may be the best solution. However, it may be difficult to convince all the entrepreneurs to pay towards a co-operative treatment system, particularly if only few members discharge substantial amounts of wastewater.

A co-operative treatment plant may be the right solution, but people forced to co-operate may not think so

In a decision that favours individual treatment systems, the application of general discharge standards may turn out to be unjust to certain enterprises, or may even discourage certain industries from settling in the estate. In a scenario where the wastewater output by the majority of the enterprises is low and only a few industries would merit environmental control, strict discharge standards enforcement for only those few may not lead to an acceptable wastewater quality at the exit of the estate, since the large number of small polluters may have greater impact than one or two severe polluters. A more moderate application of the law could be more productive because of its inherent feasibility. However, it is the decision of the administration to allow such exceptions. If discharge standards are strictly enforced, larger cash rich enterprises may opt for conventional (non-DEWATS) solutions, which are quite likely to succeed if control and operational management will be maintained. Fund starved, small-scale

units on the other hand are bound to cheat on pollution control whenever possible due to financial constraints.

Small-scale industries that have substantial wastewater production need land for final treatment systems, such as ponds or constructed wetlands which depend on natural oxygen supply via surface area. The required land ought to be provided to the individual enterprise or to the estate as a whole at a lower rate. New industrial estates are seldom connected to sewer lines immediately. Thus, provision of land for such post-treatment systems would need to be made right at the planning stages. If the pollution control officer could agree to apply the legal discharge standard at the outlet of the total estate, instead at the boundary of the individual enterprise, existing estates could use open drains as natural oxidation ditches for post treatment.

3.7 Dissemination Strategy

It would be overbearing, or at least premature to pretend to know *the* dissemination strategy for DEWATS without having in mind a particular situation. Dissemination strategies for decentralised technologies must be based on local facts and actors, explicitly, however under consideration of general factors, such as:

- the requirements of the technology itself (first of all!)
- the legal framework, and
- the conditions for funding of the necessary infrastructure, including a likely superstructure.

3.7.1 Components of Dissemination

3.7.1.1 Information

The terminology "awareness building" does not appear to do justice to the subject. While there may be a need for awareness building with the administration in some places, the existence of rules and regulations are indicative of awareness in most countries. After becoming aware of their problems, clients want information on solutions. Implicit in knowing the technology is knowledge of the limitations and conditions under which the potential of the technology can be put to use. Beside direct customers, administrators, and potential implementers (contractors and engineers, etc.), the general public also needs to be informed.

Low maintenance does not mean
NO-maintenance.

3.7.1.2 Regulation

Regulation of discharge standards play an important role to create the need for treatment and to choose the appropriate technology for it. Regulations should be flexible enough to allow appropriate alternatives without putting at risk the environmental needs.

3.7.1.3 Financing

Wastewater treatment is a cost factor and represents a substantial investment to most polluters. While financial incentives may accelerate the introduction of new technology, their prescription as a general instrument for implementation is ill advised. Nevertheless, access to soft bank loans is essential, particularly to small-scale enterprises.

3.7.1.4 Implementation

Characterised by a small building volume as base for calculating engineering fees, DEWATS understandably does not attract engineers. Engineering companies would need to be seriously persuaded to design DEWATS instead of "conventional" treatment systems of which components can be bought ready made. It may be worth subsidising engineering fees as a promotion instrument until at least that time when DEWATS becomes popular. These incentives are social investments which ought to be calculated against the future gains of a pollution free environment. In the same vein, it may be necessary to pay engineers to train contractors in DEWATS construction. One precondition for that is that expertise and knowledge about DEWATS is available with the free-lanced engineers.

3.7.1.5 Operation

Treatment plants that work without a minimum of maintenance and supervision are non-existent. It seems difficult to keep the knowledge about maintenance for sure with the polluter until maintenance becomes necessary for the first time. User training and professional maintenance would have to be guaranteed for some years at least, through a contract between the customer and the supplier.

3.7.1.6 Control

Control is the flip side of regulation. If an improved control system cannot be part of the dissemination strategy for financial or other reasons, then control must insist on the implementation of reliable technology options, such as DEWATS.

3.7.1.7 Reuse of Resources

Treating of wastewater requires a different expertise than for the re-use of wastewater and sludge in agriculture or fishery. Similarly the utilisation of biogas also requires special expertise. If the re-use of by-products is to be part of the dissemination strategy, the engagement of other appropriate agencies or individual experts to attend to this purpose may become expedient.

3.7.2 The Motors of Dissemination

3.7.2.1 The Government

As governments are primarily responsible for environmental protection, by the same convention, the responsibility for the dissemination of DEWATS should essentially also vest with the government. The government's major guiding instrument is reliable control of reasonable discharge standards. Nonetheless, a suitable legal framework may also include tax exemption, the provision of subsidies - direct or indirect- and surety for bank loans. Direct subsidies, which are perceived to distort economic competition, are no longer in vogue. Consequently it may be necessary to structure indirect financial support to activities such as awareness building, research, training, or infrastructure to non-governmental organisations (NGOs), private enterprise and professional associations to enhance the scope of dissemination. Project ideas would principally have to come from these agents.

3.7.2.2 Non-Governmental Organisations

Characteristically, NGO's play a variety of roles foremost of which is their innate support to weaker groups of society to fight

private or governmental abuse of their rights as citizens. Today a large number of NGO's are committed to environmental justice. It is not uncommon to find NGO's protesting against the violation of pollution standards and succeeding in getting the government to bring the law to bear against careless offenders or to even get the government to change archaic rules and regulations.

The role of the NGO may be extended to implementation and technical training as long as the normal "market" forces consisting of engineers and contractors have not become involved adequately. However, it is important to realise that wastewater treatment is not a matter of propaganda but a matter of applied natural science. No NGO can become an implementing agency without permanently involving persons of sufficient scientific and technical knowledge.

Wastewater treatment does not happen through propaganda, but through applied natural science.

NGOs start traditionally from acute single cases and then, with growing experience and knowledge move towards a more general approach. NGOs have the inherent potential to effectively disseminate DEWATS provided powerful persons and institutions support them in overcoming administrative bottlenecks and in accessing the funds that are needed for their activities.

3.7.2.3 Development Projects

At the one hand, development projects may either create a model reality, and try to manage it well for demonstration purposes,

or at the other hand, execute and support measures which directly influence the prevailing reality outside and beyond the project.

For demonstrating a general idea it might be effective to create a limited and controllable model reality wherein everything works well. However, it would be dangerous to believe that the model is a reflection of reality, because of the expenses involved this proposed reality can never come true.

Rural biogas dissemination and other development programmes have proved that such well-designed projects are not examples of what is really possible. The lavish organisational structures that such programmes demand are counter productive. The pressure to present a perfect project solution has proved not to bring forth a sustainable solution for the time after the project is over.

Decentralised wastewater treatment is a very complex subject that is greatly influenced by socio-economic and political circumstances. A development project is at best a modest contribution towards eliminating bottlenecks in the overall complex reality of a specific development sector.

Foreign aided development projects that are partnered by government agencies or local NGO's may be a suitable instrument to overcome financial and structural shortcomings. The character of the local partner organisation and its need for support determine the nature and character of any aid from outside.

3.7.3 Approach to Dissemination

3.7.3.1 Individual Implementation

Dissemination of DEWATS means first of all, the construction of as many plants as possible. Any private engineer who designs and initiates the construction of DEWATS for his customers, provided his plants are well designed, well constructed, well operated and well maintained is the perfect disseminator. However, his efficiency depends on the ability to acquire new customers through the propaganda about his good service.

Buildings and other structures, including established treatment systems such as septic tanks are conventionally implemented by individual contractors. Designs for septic tanks of different sizes are easily available and their construction does not require more than the usual building practice. Building contractors install septic tanks as effortlessly as they put up buildings. Anaerobic filters or constructed wetlands are not that easy to disseminate. Rigid standardisation tends to jeopardise the economy and the design principles of these systems. Consequently a deeper understanding and a higher degree of expertise is required at the level of direct implementation. This could be achieved through training or qualified supervision during construction of these "unusual" structures. However, both options would require a superstructure to execute and finance these services. Baffled septic tanks and pond systems could be disseminated with less specialised expertise.

3.7.3.2 Sector-wise Dissemination

Individual implementation would be the best approach to dissemination provided standardised designs were to be available, at least

for those cases that are most common in a given situation. Any dissemination strategy, which relies on relatively low professional standards for implementation, should best follow a sector-wise approach. For example, there could be standardised treatment systems for housing colonies of one city, for rural hospitals in a hilly area or for hotels and holiday resorts at a scenic lake. Latex sheet processing plants at small rubber farms could as well be standardised, so could plants for wastewater from rice mills or canning factories.

Tab. 2.

Average data of domestic wastewater at various places

Some selected domestic wastewater data					
examples	COD g/cap.*d	BOD ₅ g/cap.*d	COD / BOD ₅	SS g/cap*d	Flow l/cap*d
India urban	76	40	1,90	230	180
USA urban	180	80	2,25	90	265
China pub.toilet	760	330	2,30	60	230
Germany urban	100	60	1,67	75	200
France rural	78	33	2,36	28	150
France urban	90	55	1,64	60	250

BORDA

Before the propagation of standard designs for a whole sector, it is essential to build and operate some plants in order to obtain reliable data for the calculation of dimensions and to gain overall experience. The question of who will finance and execute those trials necessitates the installation of a superstructure for planning and other supervisory purposes.

However, the pure sector-wise approach is likely to fail under the sheer weight of demand on an expertise, which is still rare. Potential customers, who have other than the standard problem, are likely to approach anyone constructing such standardised plants regardless of sector specific exper-

tise. The engineer or contractor is likely to waste a lot of time in visiting such places and in finding technical solutions in order to build up the reputation of his enterprise or simply for want of other customers.

A wastewater treatment plant is
NOT just another pair of shoes

3.7.3.3 Marketing

Ultimately technology finds its justification in the "market". If DEWATS cannot find a market it will be out of business. So, beyond doubt DEWATS must marketed. How-

ever, the marketing concept of DEWATS has to be based on the specifics of the technology; it is not comparable for instance with the marketing of a brand of ready-made consumer goods.

For marketing sports shoes such as "Nike" or "Adidas" for

instance, one needs the product and a lot of ballyhoo to make the name known to the target group. The brand name carries an image that fetches prices far beyond the total cost. The shoes are easily transportable to any spot on planet earth and when the shoes are sold, the business is over.

It may not be that easy with other products. When "Toyota" conquered the European market, or "Volkswagen" entered the US-market for selling their cars, the first thing they did was to set up a network of service stations. They knew that no one would buy a car without having access to professional service facilities. Only after the service network was installed, was the proc-

Tab. 3.
Average data of industrial wastewater

Average qualities of industrial wastewaters					
production	COD mg/l	BOD ₅ mg/l	settleable solids mg/l	COD / BOD ₅	other indicators
leather	860	290	1.168	3,0	pH 8,8
glues from skin	6.000	3.100	25	1,9	
glues from leather	1.600	340	75	4,7	
fish meal	6.100	1.560	20	3,9	pH 8,2
paper	820	410		2,0	Cl 6400 mg/l
pharmaceutica	1.920	1.000		1,9	pH 6,5 - 9
starch - maize	17.600	11.540	25	1,5	N 800 mg/l
-dito- (water recycl.)	2.920	1.700		1,7	N 25 mg/l
pectine	13.800	5.800		2,4	pH 2; N 700 mg/l
vegetable oil	600	350	1	1,7	pH 5-9
potato chips	1.730	1.270	820	1,4	
canned juice	550	800	20	0,7	pH 4,6 - 11,4
tinned fish	1.970	1.390	60	1,4	Cl 3020 mg/l
beer	1.420	880		1,6	
yeast	15.000	10.250	5	1,5	pH 4,8 - 6,5

ATV

ess of selling started. The customers know that if service was neglected the result could be unreliable performance and/or low resale value. As with sport shoes the price of cars depends not only on the cost of production and on expectations of economic benefit but ultimately it is the image that the car lends to its owner that counts.

DEWATS are neither shoes nor cars. DEWATS are different. It does not belong to these categories. DEWATS are costly, space consuming, demand attendance and may even be stinking structures, which cannot be produced under controlled factory conditions. Their design is often to be adapted locally and constructed on-site by craftsmen of uncertain qualification. The customer does not love the plant, as he would love his car or even his shoes (only wastewater engineers love wastewater plants). All the customer wants is a service, but he wants not to be bothered with the inner workings of the plant. Understandably the marketing of DEWATS will have to be different.

DEWATS is not likely to have the backing of a financially strong company behind the product that could invest in preparing the market prior to the release of the product. The marketing strategy for DEWATS will have to depend first of all on the immediate availability of the product. To sell DEWATS one needs engineers and contractors being present at remote sites which may be several hours away from their office. Howsoever, advertising, which introduces the product to the public could start well before the product is available. The subject of such an advertising campaign remains a question, when nothing is truly ready to be sold and the price of the product is not known, yet.

Marketing experts know that any marketing strategy has to start from the technical and economic potential of the company that is selling; and that a marketing strategy is reaching its target when customers actually put money on the

desk for buying the product. Successful marketing strategies are premised on buying power and supply capacity, which have to be known in the local context. The best salesmen usually cannot sell a product that is not available, to a customer that does not have the money to buy it.

A product that is not available to be shown to customers is by no means easy to sell. By this logic, the existence of well-functioning wastewater treatment demonstration plants are a vital pre-condition for successful marketing.

4 ECONOMICS

4.1 Economy of Wastewater Treatment

Wastewater, as the name suggests is a waste, which is left over after using water for a specific purpose. Treating wastewater to get back its original quality is an additional process, which has its price. If wastewater treatment would be profitable in itself, the *perpetuum mobile* would have been invented. Instead, wastewater treatment is by scientific principle a cost factor.

The cost of treatment depends on the degree and the kind of water pollution as well as the degree of purification to be achieved. Treatment costs can be reduced by reducing the pollution, by choosing an appropriate degree of treatment, and in some cases by reusing water and sludge and/or by utilising the biogas. The recovery of other valuable raw material for reuse within the industrial production process does rarely take place in the case of DEWATS.

The objective need (and legal demand) for wastewater treatment today is a result of environmental pollution that has taken place in the past. The extent to which wastewater treatment can be justified in economic terms will depend on the parameters that are included in the economic calculation. One rather unfamiliar parameter is the valuation of environmental protection. How should environmental protection be valued remains a question, however, the issue of whether water should at all be treated is passé. Fact is that there are laws and by-laws, which demand a certain effluent quality of any wastewater discharged into the environment.

This to the polluter means that water must be treated at any cost, or not discharged at all. And this is the starting point for economic considerations.

The first economic question is "Why", only the second question is "How much"

In the first instance, the economy of wastewater treatment demands the reduction of unavoidable expense. Economising measures primarily recognise the prevailing economic environment and adapt the treatment system accordingly; or if possible, create an economic environment that suits and supports the preferred treatment system.

Treatment cost for a given wastewater are influenced by:

- the legal discharge standard,
- the chosen treatment system, and
- the degree of reusing water, sludge and energy (biogas)

The treatment system to be chosen and whether the reuse of by-products is advisable will depend on local prices for building materials and service manpower. The question of reasonable discharge standards has been dealt with in chapter 3, already. It is not discussed here.

4.2 Treatment Alternatives

The question at a policy or development planning level relates to the extent to which water should be treated and its discharge

centralised, and whether on-site treatment and individual discharge into the environment should be available as an option at all. The decision is influenced by environmental, social, technical and economic parameters within which the place of final discharge is likely to play a decisive role. *Alaerts et al* suggests a population density of above 200 to 600 capita/ha for centralised treatment of domestic wastewater. However, such a general rule of thumb cannot be taken as valid for conglomerations including industries; it demands cautious application.

The following considerations in balancing centralised against decentralised treatment systems are recommended:

- There are clear cut economies of scale for treatment plants so long as the level of technology is not changed.
- DEWATS in principle - but not always - are cheaper because they are of lower technological standard than conventional treatment plants.
- The unavoidable costs of sewer lines in case of centralised systems may threaten the economies of scale; sewerage may cost up to five times more than the central sewage plant itself.
- The cost of treatment increases proportionate to the degree of treatment.
- Management costs are in principle - but not necessarily - in direct relation to plant size or to the number of plants.

There are several organisational alternatives for treatment and discharge of wastewater. These are:

- Controlled discharge without treatment (ground percolation, surface water dilution).

- Treatment in a centralised plant that is connected to a combined or separate sewer system.
- Treatment in several medium sized treatment plants that are connected to a combined or separate sewer system.
- Primary and secondary treatment in decentralised plants that are connected to a sewer line, that leads to a common plant for final treatment.
- Completely decentralised treatment with direct and final discharge, or connection to communal sewerage.

This book deals with DEWATS as an option and tries to describe its specificities. It would be beyond the scope of this handbook to deal with the general subject of sanitation concepts suitable for communities. Enough work of excellence has been done and published by specialist groups in different countries. For example:

Alaerts, G.J., Veenstra, S., Bentvelsen, M., van Duijl, L.A. at al.: "Feasibility of anaerobic Sewage Treatment in Sanitation Strategies in Developing Countries" IHE Report Series 20, International Institute for Hydraulic and Environmental Engineering, Delft 1990.

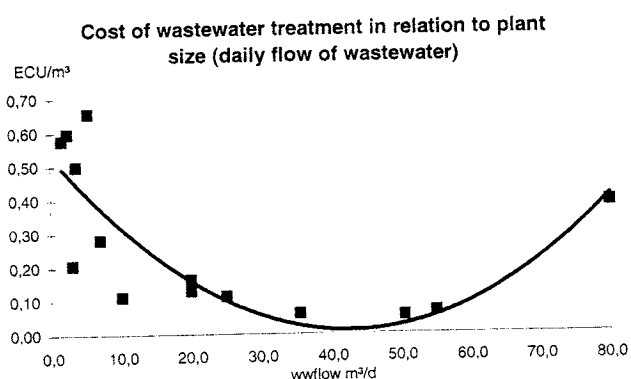

Fig. 4. Cost of treatment per m³ daily flow. Larger plants require a more sophisticated technology which may increase treatment costs.

Once the decentralised option has been chosen, it is the individual polluter who should decide on the treatment system he thinks is most suitable to his circumstance. However, realistic alternatives based on true economic considerations are rare. *The Danish Academy of Technical Sciences* writes in its evaluating report 1984:

"...It has been shown that, under certain local circumstances, large variations in economy are to be expected, but the general conclusion (...) is that the economy of the various treatment processes does not differ that much. In many cases the costs are approximately the same. This increases the importance of those factors which cannot be included in an economic survey. Some of these factors are limiting factors in the sense that they limit the "free" selection between the various methods. If large areas of land are not available, then oxidation ponds must be disregarded even if it is the most economically favourable solution. If electricity supply is unreliable, then activated sludge systems cannot be considered. (...) It can be argued that the factors mentioned above are of purely economical nature, e.g. a reliable electricity supply is merely (!) a matter of economy. However, the costs involved in changing these factors to non-limiting factors are so high that there is no point in including such considerations here."

(The Danish Academy of Technical Sciences: "Industrial Wastewater Treatment in Developing Countries", 1984)

The above citation supports the view that comparison of several alternatives is not possible on a general level, and in most cases true alternatives for the customer do not exist. There are many cases, where a DEWATS concept is the only solution that promises some degree of continuous treatment. Most often, it is not worth comparing DEWATS with non-DEWATS solutions if obviously the cost and management effort of keeping a conventional system permanently in operation is formidable. It could

be very expensive for instance, to keep a qualified engineer at a remote location for operating a conventional, albeit small treatment plant.

Field experiences indicate that there are factors other than economic, which induce the polluter to opt for a treatment plant. In most cases the pressure to comply with discharge standards that meet the law compel polluters into the decision. However, there could be other reasons as well. For example, an entrepreneur would like a treatment plant to present a "clean" factory to his foreign partners, a housing complex that has no future unless wastewater is reused for irrigation, or a doctor in charge of a teaching hospital who wants to treat the hospital wastewater to safeguard his reputation. In all these cases the immediate motivation to go in for wastewater treatment is other than economic (notwithstanding the fact that some economists consider „everything“ an economic question).

After deciding in favour of a treatment plant, the polluter would want to compare different systems of the same size under similar conditions. He would want to consider the space he has to spare for the treatment system, the level of maintenance he is willing to shoulder, and ultimately if he should rather re-organise his water consumption in order to reduce the pollution load or quantity of discharge. The geography of the neighbourhood and the prevailing wastewater discharge standards and regulations would determine the range of alternatives available to an individual polluter. Similarly the prevailing socio-political framework is also likely to have a strong bearing on the decision of the polluter, e.g., are the fees or penalties imposed based on pollution loads, or are they independent from it.

Finally, the ultimate destination of the effluent will also influence the choice of treatment system. For instance, the necessity of nitrogen or phosphorous removal may be greater when the receiving water is an isolated lake of particular ecological importance, in which case other treatment options with other influencing factors may become valid.

First think of ponds, then of tanks,
at last of filters

The following chapter describes the parameters that influence economic calculation. Those parameters help in deciding on the most suitable system for standardisation for a particular group of polluters in a defined local situation. For relatively small plants, however, it is not very likely that the supplier would offer comparative economic calculations for different treatment systems to a potential customer. If such were to be the case, the cost of planning would be unaffordable, as several plants would have to be designed on the table purely for the purpose of economic comparison. More practically, the potential supplier is more likely to discuss various alternatives with the potential customer (without going into detailed economic calculations) based on which the customer would then choose the most appropriate and convenient solution.

4.3 Parameters for Economic Calculation

4.3.1 Methods of Comparison

Wastewater treatment as a rule does not produce profit. Resultantly methods of economic analysis such as cost-benefit or break even point, to which profit calculations are important, do not fit the economy of waste-

water treatment. On the other hand, the annual cost method, which includes depreciation on capital investment and operational costs, appears to be more apt as an economic indicator. With this method it is easy for the polluter to include expenses such as discharge fees, or income from re-use of by-products on an annual base, to get a comprehensive picture of the economic implications.

The annual cost method could also be used for estimating social costs and benefits. The economic impact of treatment on the environment and on public health is related primarily to the context in which a treatment plant operates. For example, if properly treated wastewater is discharged into a river that is already highly polluted the yield from fishing will surely not improve. On the contrary, if all the inflows into the receiving water were to be treated to the extent that the self-purifying effect of the river would allow the fish to grow, this would have considerable economic impact. This economic impact of a cleaner river is crucially dependent on the total number of treatment plants installed along the river, and not only on the efficiency of one single plant.

A spreadsheet for computerised calculations is presented in chapter 13.2.

4.3.2 Investment cost

4.3.2.1 Cost of land

For economic calculation the value of land remains the same over years and thus, land has unlimited lifetime. However, the price of land is never stable. It usually goes up in times of growth and may go down in times of political turbulence. In reality, the actual availability of land is far more important

than the price; new land will rarely be bought only for the purpose of a treatment plant. The density of population usually determines the price of land. Land is likely to cost more in areas with a high population density and vice versa. The choice of treatment system is severely influenced by these facts.

In reality, the cost of land may or may not be essential to the comparison between different treatment systems. Wide differences in the cost of land notwithstanding, it may contribute in the range of 80% of the total cost of construction. It follows that at least in theory, the choice of sand filters and of ponds will be more affected by the price of land than compact anaerobic digesters. In any case, it is most likely that where land prices are high compact tanks - not ponds and filters - will be the natural choice. *Alaerts et al.* assume that ponds are the cheapest alternative when the cost of land is in the range of less than 15 US\$/m² in case of post treatment and 3 - 8 US\$/m² in case of full treatment. Such figures nonetheless have always to be checked locally.

4.3.2.2 Construction cost

Annual costs are influenced by the lifetime of the hardware. It may be assumed that building and ground structures have a lifetime of 20 years; while filter media, some pipelines, manhole covers, etc. are only likely to last for 10 years. Other equipment such as valves, gas pipes, etc., may stay durable for 6 years. Practically it suffices to relate any structural element to any one of these three categories.

It is assumed that full planning costs will reoccur at the end of the lifetime of the main structure, i.e. in about 20 years. In any individual case, the costs of planning

can be estimated. For dissemination programmes, it may be assumed that planning will be carried out by a local engineering team of sound experience to whom the design and implementation of DEWATS is a routine matter. However, this might not be so in reality. At the contrary, of all costs, engineering costs are likely to be the most exorbitant and to remain so until such time as the level of local engineering capacity improves. An estimation of planning work-days for senior and junior staff forms the basis of calculation to which 100% may be added towards acquisition and general office overheads. Transport of personnel for building supervision and sample taking - and laboratory cost for initial testing of unknown wastewater's must also be included.

4.3.3 Running Costs

Running expenses include the cost of personnel for operation, maintenance and management, including monitoring. Cost may be based on the time taken by qualified staff (inclusive of staff trained on the job) to attend to the plant. The time for plant operation is normally assessed on a weekly basis. In reality, the time estimated for inspection and attendance would hardly call for additional payment to those staff who are permanently employed. The case would be different for service personal that is specially hired. Facilities that are shared, as in the case of 5 to 10 households joining their sewers to one DEWATS, are likely to be 10% cheaper than individual plants. However, operational reliability of such a facility cannot be guaranteed if someone is not specially assigned to the task of maintenance.

Cost for regular attendance could be higher for open systems such as ponds or constructed wetlands due to the occasional damage or disturbance by animals, stormy weather or falling leaves. The cost of regular de-sludging will be higher for tanks with high pollution loads, than for ponds which receive only pre-treated wastewater. The cost of cleaning the filter material is not considered to be running cost as these costs are taken care off by the reduced lifetime of the particular structure. So also the cost of energy and chemicals that are added permanently are not included, as such costs are not typical of DEWATS.

4.3.4 Income from Wastewater Treatment

The calculation of income from by-products or activities related to wastewater treatment calls for careful selection of the right economic parameters. Biogas could be assumed to have economic value as it is seen to substitute other fuels, whereas in reality it may be only an additional source of energy of nil utility and consequently zero economic value. Just as the use of water and sludge for agriculture may require the establishment of additional infrastructure and staff to manage its utilisation. As is apparent, economic calculations if not reflective of all these costs and future implications could become redundant.

Biogas production should be taken into the calculation only if the biogas is likely to be used. The biogas production available to use may be to the extent of 200 l per kg COD_{removed}. The actual gas production is 350 l methane (500 l biogas) per kg BOD_{total}, however a part of the biogas would be dis-

solved in water; the portion increases with decreasing wastewater strength. Biogas contains 60% to 70% methane. 1 m³ methane is equivalent to approximately 0,85 litre of kerosene.

The moot question is really not if the use of biogas will improve the profitability of the wastewater treatment plant but whether the additional investment to facilitate the use of biogas is economically justified. If biogas were to be used, the storage of the gas would demand additional volume and a gas-tight structure. The gas would then need to be transported to the place of consumption, requiring pipes and valves. The proper utilisation of the gas and maintenance of the gas supply system will entail additional management and thereby additional costs. The additional investment to facilitate the use of biogas is likely to add up to 5% of the cost of long lasting structures

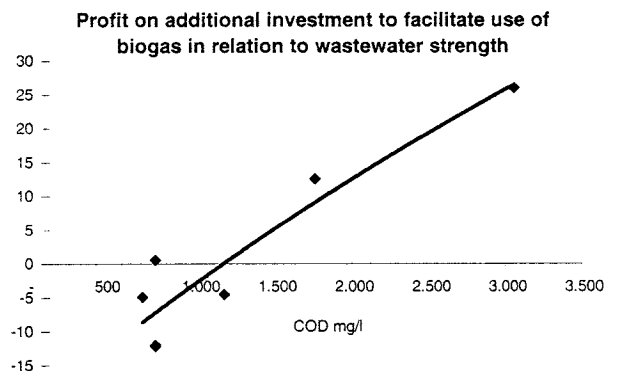

Fig. 5. Cost-benefit relation of biogas utilisation. It is not economical to use biogas from low strength wastewater.

(20 years lifetime), 30% of the cost of internal structures (10 years lifetime) and 100% of the cost of equipment (6 years lifetime). The cost of the additional capital for such investments is not to be forgotten.

Furthermore the cost of operational attendance is likely to be 50% more if the biogas was to be used. If agriculture and fish-farming were to be attached to the wastewater treatment plant the economic implications are much more complex and therefore much more difficult to assess *a priori*. The size and organisation of the farm together with the marketing of the crops would be important parameters to consider.

4.3.5 Capital Costs

If the investment capital were to be borrowed from the bank on interest, such investment would attract direct capital costs. On the contrary, when one's own money is invested which if used otherwise could be profitable (purchase of raw material for production, investment in shares or bank de-

posits, etc.) the cost of this capital is indirect. The risk of the investment is another factor that may have to be taken into account and that can make the calculation of the cost of capital extremely complex.

In case of wastewater treatment plants since other profits are in any case not expected, the investment risk is limited to the technical risk of the reliability of performance. However, if profits from wastewater related agriculture is expected, the investment risk could become expensive. Capital costs are to a certain extent speculative by nature. Nevertheless, the fact that capital costs money remains.

For strategic calculations one may consider annual capital costs of 8% to 15 % of the investment; exclusive of inflation as inflation affects both the creditor and the debtor in equal measure.

5 PROCESS OF WASTEWATER TREATMENT

5.1 Definition

The term 'treatment' means separation of solids and stabilisation of pollutants. In turn, stabilisation means the degradation of organic matter until the point at which chemical or biological reactions stop. Treatment can also mean the removal of toxic or otherwise dangerous substances (for example heavy metals or phosphorus) which are likely to distort sustainable biological cycles, even after stabilisation of the organic matter. Polishing is the last step of treatment. It is the removal of stabilised or otherwise inactive suspended substances in order to clarify the water physically (for example reducing turbidity).

Treatment systems are more stable if each treatment step removes only the „easy part“ of the pollution load, but sends the leftovers to the next step.

5.2 Basics of Biological Treatment

The stabilising part of treatment happens through degradation of organic substances via chemical processes, which are biologically steered (bio-chemical processes). This steering process is the result of the bacte-

rial metabolism in which complex and high-energy molecules are transformed into simpler, low-energy molecules. Metabolism is nothing but the transformation from feed to faeces in order to gain energy for life, in this case for the life of bacteria. That metabolism happens when there is a net energy-gain for "driving" the bacteria. It is important for the bacteria that energy can be stored and released in small doses when needed (adenosine triphosphate - ATP - is the universal medium to store and transport energy). A few chemical reactions happen without the help of bacteria.

In the main, wastewater treatment is a matter of degradation of organic compounds, and finally a matter of oxidising carbon (C) to carbon dioxide (CO_2), nitrogen (N) to nitrate (NO_3), phosphorus (P) to phosphate (PO_4) and sulphur (S) to sulphate (SO_4). Hydrogen (H) is also oxidised to water (H_2O). In anaerobic processes some of the sulphur is formed into hydrogen sulphide (H_2S) which is recognisable by its typical "rotten eggs" smell. The largest amount of oxygen (O_2) is required for burning carbon ("wet combustion").

The process of oxidation happens aerobically, with free dissolved oxygen (DO) present

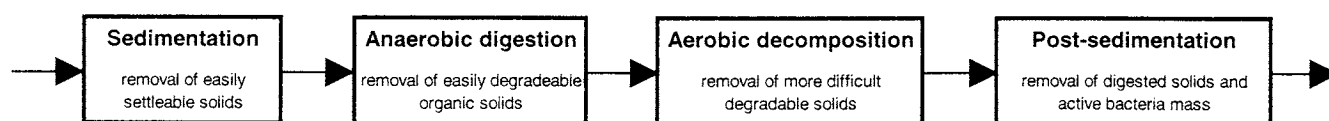

Fig. 6. Several steps are required for full treatment.

in water, or anaerobically without oxygen from outside the degrading molecules. Anoxic oxidation takes place when oxygen is taken from other organic substances. Facultative processes include aerobic, anoxic and anaerobic conditions, which prevail at the same time at various parts of the same vessel or at the same place after each other. In anoxic respiration and anaerobic fermentation as there is no oxygen available, all oxygen must come from substances within the substrate. Anaerobic treatment is never as complete as aerobic treatment, because there is not enough oxygen available within the substrate itself.

The chemical reactions under aerobic, anoxic and anaerobic conditions are illustrated by the decomposition of glucose:

Decomposition via aerobic respiration



Decomposition via anoxic respiration

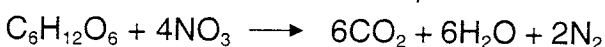

Decomposition via anaerobic fermentation

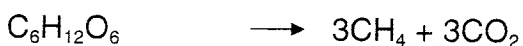

Bacteria need nutrients to grow. Any living cell consists of C, H, O, N, P and S. Consequently, any biological degradation demands N, P and S beside C, H and O. Trace elements are also needed to form specific enzymes. Enzymes are specialised molecules, which act as a kind of "key" to "open-up" complex molecules for further degradation.

Carbohydrates and fats (lipids) are composed of C, O and H and cannot be fermented in pure form (Lipids are "ester" of alcohol and fatty acids; an ester is a composition that occurs when water separates off). Proteins are composed of several amino acids. Each

Principle of the anaerobic process

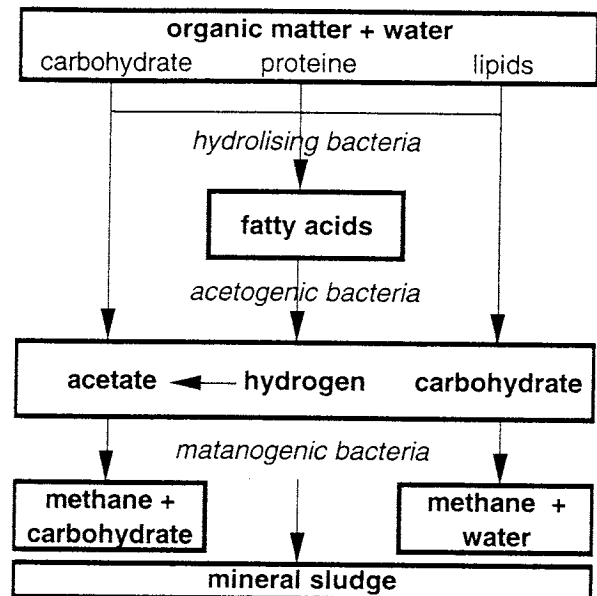

Karstens / Berthe-Corti

Fig. 7.
The anaerobic process in principle

Simplified Principle of the Aerobic Process

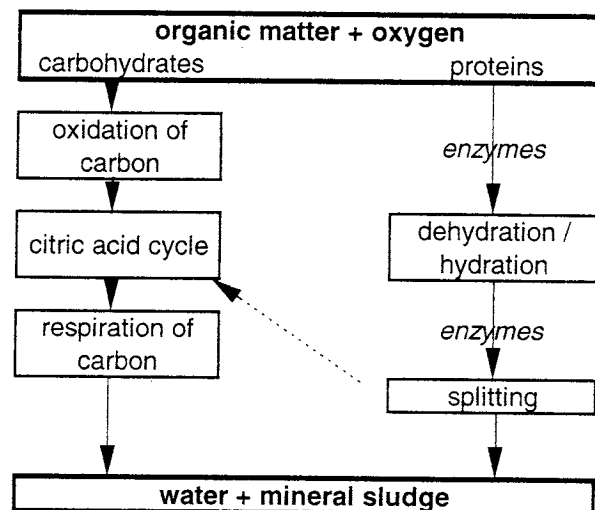

The aerobic process is very diverse; the above diagram has been almost unacceptably simplified. However, it shows that carbohydrates and proteins undergo different steps of decomposition. It also shows the importance of enzymes for breaking up proteins.

Fig. 8.
The aerobic process in principle

amino acid is composed of a COOH-group and a NH₃-group plus P, S, Mg or other necessary trace elements. Thus, proteins contain all the necessary elements and consequently, can be fermented alone. A favourable proportion between C, N, P and S (varying around a range of 50: 4: 1: 1) is a pre-condition for optimum treatment.

5.3 Aerobic - Anaerobic

Aerobic decomposition takes place when dissolved oxygen is present in water. Composting is also an aerobic process.

Anoxic digestion happens when dissolved oxygen is not available. Bacteria however, get oxygen for "combustion" of energy by breaking it away from other, mostly organic substances present in wastewater, predominantly from nitric oxides.

Anaerobic digestion happens by breaking up molecules which are composed of oxygen and carbon to ferment to carbohydrate.

The aerobic process happens much faster than anaerobic digestion and for that reason dominates always when free oxygen is available. The high speed at which decomposition takes place is caused by the shorter reproduction cycles of aerobic bacteria as compared to anaerobic bacteria. Anaerobic bacteria leave some of the energy unused. It is this unused energy which is released in form of biogas. Aerobic bacteria use a larger portion of the pollution load for production of their own bacterial mass compared to anaerobic bacteria, which is why aerobic processes produce twice as much sludge as compared to the anaerobic process. For the same reason, anaerobic sludge is less slimy than aerobic sludge and is therefore

easier to drain and to dry.

Aerobic treatment is highly efficient when there is enough oxygen available. Compact aerobic treatment tanks need external oxygen which must artificially be supplied by blowing or via surface agitation. Such technical input consumes technical energy.

The anaerobic treatment process is slower. It demands a higher digestion temperature *quasi* to make good for the unused nutrient energy. The anaerobic treatment process is supported by higher ambient temperature. Therefore, it plays an important role for DEWATS in tropical and subtropical countries. Ambient temperature between 15° and 40°C is sufficient. Anaerobic digestion (fermentation) releases biogas (CH₄ + CO₂) which is usable as a fuel.

5.4 Phase Separation

The term "phase separation" is used for two rather different affairs. On the one hand it is used for the separation of gas, liquid and solids in anaerobic reactors. On the other hand it is used to describe the technical separation of different stages of the treatment process, either in different locations or in sequences of time intervals. The latter kind of phase separation becomes necessary, when suitable nutrients cannot be provided simultaneously to bacteria that have differential growth rates and prefer different feed. Some bacteria multiply slowly while others grow rapidly. As all the enzymes required for degradation are not found in all substances, the bacteria take time to produce adequate amounts of the missing enzymes. As was said before, enzymes act as the "key which opens the lock of the food box for bacteria".

Substrates for which enzymes are immediately available are „easily degradable“. Whereas, those substrates for which enzymes have first to be produced by bacterial action are „difficult“ degradable. In an environment, which hosts substances that are both easy and difficult to degrade, the bacterial population, which is responsible for easy degradation tends to predominate over the others.

To protect the “weaker” (slower) bacteria, it may be advisable to artificially separate different bacterial populations in phases by providing each with its own favourable environment. Characteristics of wastewater must be known and the desired treatment results must be decided, before the dimensions of the vessels for the different phases can be selected.

Nature follows its laws.
Wishes are not laws of nature.

In case of DEWATS, it is often easiest to provide longer retention times so that the “slow” bacteria find their food after the “quick” bacteria have consumed their requirements. This process is easier to manage than phase separation; in the case of smaller plants, it is also cheaper. However, the efficiency of phase separation in the baffled septic tank justifies its higher costs. It is definitely far more appropriate than feeding the plant with sequencing flow rates, the process of which needs steering and control. Phase separation becomes unavoidable if different phases require either anaerobic or aerobic conditions.

Pre-composting of plant residues before anaerobic digestion is an example of simple phase separation, where lignin is de-

composed aerobically before anaerobic bacteria can reach the inner parts of the plant material (lignin cannot be digested anaerobically because of its “closed” molecular structure).

In case of nitrogen removal, longer retention times alone do not solve the problem because the nitrifying phase needs an aerobic environment, while denitrification requires an anoxic environment. Anoxic means that nitrate (NO_3) oxygen is available, but free oxygen is not. Anaerobic means that neither free oxygen nor nitrate-oxygen is available. Nevertheless, the aerobic phase can only lead to nitrification if the retention time is long enough for the “slow” nitrifying bacterium to act, as compared to the “quick” carbon oxidizers.

5.5 Separation of Solids

Wastewater treatment relies on the separation of solids, both before and after stabilization. Even dissolved particles are decomposed into the three main fractions: water, gases and solids of which the solids will have to be removed, finally. The choice of method of solids removal will depend on the size and specific weight of pieces and particles of suspended solids.

5.5.1 Screening

Screening of larger pieces of solids is considered to be the foremost step in any treatment plant. In DEWATS, screening is not advisable, for the reason that screens require cleaning at very short intervals, i.e. daily or weekly, which needs a safe place in the immediate vicinity for the screenings that are removed. A blocked screen is an

Tab. 4.

Settling speed of coarse particles. Suspended sludge particles have settling properties different from coarse particles.

grain size in mm	1	0,5	0,2	0,1	0,05	0,01	0,005
quartz sand	502	258	82	24	6,1	0,3	0,06
coal	152	76	26	7,6	1,5	0,08	0,015
SS in domestic wastewater	120	60	15	3	0,75	0,03	0,008

K.+K. Imhoff, pg. 126

obstacle that blocks the entrance of the plant, however, DEWATS should allow for the full amount of wastewater to pass through the plant without blockage or overflow. If this fails, it may happen - and in fact happens quite often - that the operator „organises“ a trouble free by-pass, which would pollute the environment as if a treatment plant did not exist. For this reason it seems wise to avoid the screen and alternately to provide sufficient additional space to accommodate solids of larger size within the first sedimentation chamber.

5.5.2 Sedimentation

Separation of solids happens primarily by gravity, predominantly through sedimentation. Coarse and heavy particles settle within a few minutes or hours, while smaller and lighter particles may need days and weeks to finally sink to the bottom. Small particles may cling together, forming larger flocks that also sink quickly. Such flocculation happens always when there is enough time and little to no turbulence. Consequently, stirring hinders quick sedimentation. Sedimentation is slow in highly viscose substrate.

Sedimentation of sand and other discrete particles takes place best in vessels with a relatively large surface. These vessels may be shallow, since depths of more than 50 cm are of no influence to the sedi-

tation process in the case of discrete particles.

This is different for finer coagulant particles, where sedimentation increases with basin depth. That is because

settling particles meet suspended particles to form flocs which continue to grow larger and larger on their way to the bottom. A slow and non-turbulent flow - still and undisturbed water - supports “natural” coagulation for sedimentation.

Settled particles accumulate at the bottom. In the case of wastewater, any sediment also contains organic substances that start to decompose. This happens in any sludge sedimentation basin and to a lesser extent in grit chambers. Decomposition of organic matter means formation of gases, firstly carbon dioxide but also methane and others. These gases are trapped in sludge particles that float to the top when the numbers of gas molecules increase. This process not only causes turbulence; it also ruins the success of the sedimentation that has taken place. The Imhoff tank through its baffles prevents such gas-driven particles from “coming back” to spoil the effluent. The UASB process deliberately plays with the balance of sedimentation (= downstream velocity) and up-flow of sludge particles (= upstream velocity).

After decomposition and release of gases, the stabilised (mineralised) sludge settles permanently at the bottom where it accumulates and occupies tank volume, unnecessarily. This is why it must be removed at regular intervals. Since several pathogens especially helminths also settle well, sedi-

mentation plays an important role in hygienic safety of domestic or husbandry wastewater.

5.5.3 Floatation

Floatation is the predominant method to remove fat, grease and oil. In advanced conventional wastewater treatment it is also used to remove small particles with the help of fine air bubbles blown in from the bottom.

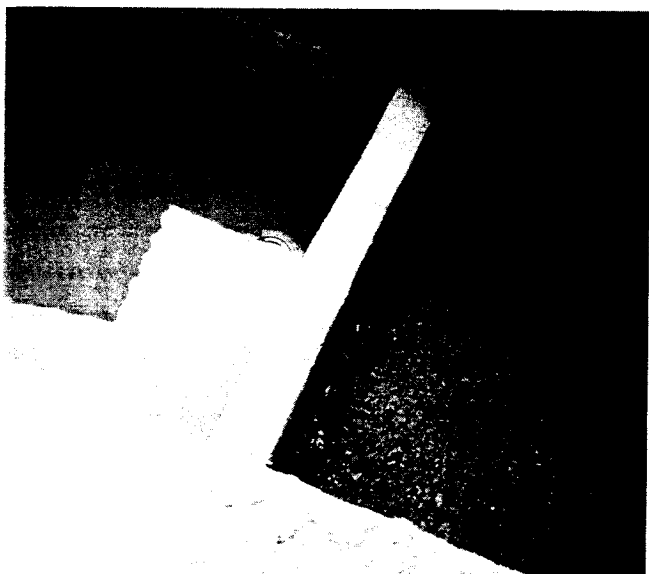

Fig. 9. Partition wall retaining scum. Inlet is at the right side, water flows below the partition wall into the compartment at the left side. [photo: Sasse]

Most fatty matter can be checked by simple observation tests, similar to settleable solids. If fats which are detected by laboratory analysis are not separated by floatation they present themselves as colloids which can only be removed after pre-treatment (after acidification, e.g.).

Unwanted floatation happens in septic tanks and other anaerobic systems where float-

ing layers of scum are easily formed. Accumulating scum could be removed manually, or could be left purposely to "seal" the surface of anaerobic ponds to prevent bad odour.

Floatation and sedimentation, can be supported by using slanting multi-laminated sheets or several layers of slanting pipes that intensify the separation of solids from liquids because the surface of floatation or sedimentation is artificially multiplied.

5.5.4 Filtration

Filtration becomes necessary when suspended solid particles are to be removed that cannot be forced to settle or to float within a reasonable time, or that cannot be filtered by "self-flocculation".

Most filters have a double function: They provide a fixed surface for treatment bacteria and they form a physical obstacle for smaller solid particles. Physical filters retain solids which accumulate, unless they are removed from time to time. Rather coarse filters, where physical filtration happens with the help of the bacteria film in the first place, can be cleaned by flushing. Bacteria and suspended solids are flushed away simultaneously as for example is typically done in trickling filters. Upstream filters may be back-flushed. Sand and finer gravel filters after some years, must be cleaned by replacing the filter media. The filter media is reusable after washing.

Needless to say that filtration is more effective with smaller grain size. Unfortunately it is also true that effective filtration requires the retention of many solids and therefore, clogs faster. The permeability and

durability of filters is always reciprocal to its treatment efficiency. Filter material of round and almost equal grain size is more efficient and renders longer service than filters of mixed grain size.

Aerobic filters produce more sludge than anaerobic filters and consequently would block faster. However, the filter has a certain self-cleaning effect when given sufficient resting time, because the aerobic sludge consists of living bacteria, which practise a kind of „cannibalism“ (autolysis) when nutrient supply stops.

Sludge removal intervals are therefore an important design criteria. (see also *Fig. 67.*) Sludge may be removed continuously in case of modern sewage plants, or after several years in case of anaerobic stabilisation ponds.

5.6 Elimination of Nitrogen

Nitrogen is a nutrient that causes algae growth in receiving waters and therefore must be removed from wastewater before discharge. It is also poisonous to fish in the form of ammonia gases and may also become poisonous in the form of nitrite. The basic process of nitrogen removal happens in two steps, namely nitrification followed by denitrification, with the result that pure nitrogen diffuses into the atmosphere.

Nitrification is oxidation. Nitrate is the most stable form of nitrogen and its presence indicates complete oxidation. Denitrification is reduction, or in other words the separation of that very oxygen from the oxidised nitrogen. The pure gaseous nitrogen that remains is in-

soluble in water, and therefore evaporates easily. Since nitrogen is the major compound of air it is ecologically completely harmless. The evaporating nitrogen from the denitrification process may cause floating foam or scum, similar to the effect seen from the gas release by settled anaerobic sludge.

During nitrification NH_3 (ammonia) is oxidised by a special group of bacteria - called nitrobacter - to NO_3 (nitrate). Because *nitro-*

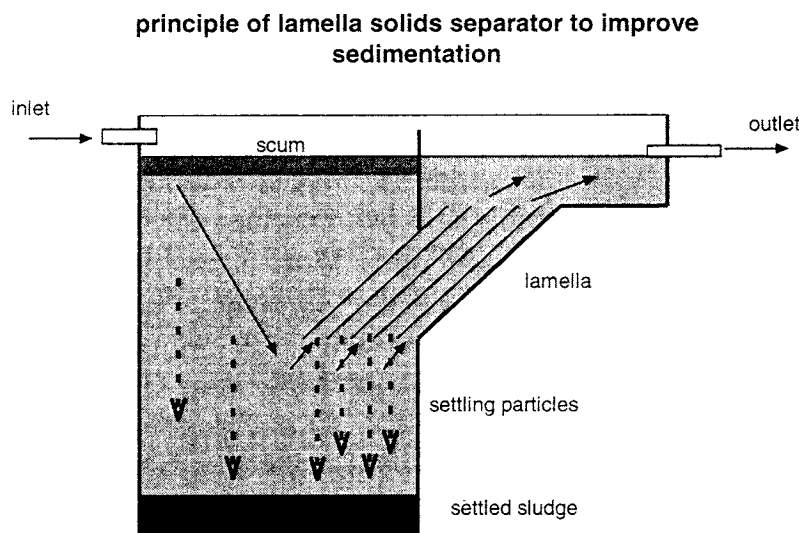

Fig. 10.
Lamella solids separator, lamella may be made of plastic sheets, concrete slabs or PVC pipes.

5.5.5 Sludge accumulation

Sedimentation and filtration leads to sludge accumulation at the bottom of vessels (see chapter 8.3). In course of time, this sludge gets compacted, consequently older sludge occupies less volume than fresh sludge.

bacter grow slowly, a higher sludge age caused by longer retention times is needed for oxidation of nitrogen (= nitrification) than is required for oxidation of carbon (see chapter 7.6).

Shorter retention times are required to cause denitrification under anoxic conditions (absence of free oxygen) because there are not only a few but several groups of bacteria able to denitrify, that is to utilise nitrate oxygen. Remaining or additional organic matter is required for denitrification.

Incomplete denitrification may lead to formation of the poisonous nitrite (NO_2), instead of nitrate (NO_3). This happens because the time left for the bacteria to consume all the oxygen is not enough or because there is not enough organic material left to absorb the NO_3 -oxygen. Some non-DEWATS treatment processes recycle nutritious sludge to prevent such nutrient deficiency. A certain amount of nitrate in the effluent could also be a source of oxygen for the receiving water.

In case of DEWATS, nitrate removal normally does not receive special attention, in that additional technical measures are not taken.

5.7 Elimination of Phosphorus

Bacteria cannot transform phosphorus into a form in which it loses its fertiliser quality permanently. Phosphorus compounds remain potential phosphate suppliers. This implies that no appropriate biological process, either aerobic or anaerobic can remove phosphorus from wastewater. Phosphorus removal from water "normally" takes place by removal of bacteria mass (active sludge) or by removal of phosphate fixing solids via sedimentation or flocculation. Iron chlo-

ride, aluminium sulphate or lime fix phosphates, a fact that can be utilised by selecting suitable soils in ground filters. However, removal of phosphorus in root zone filters has not proved to be as efficient and sustainable as expected and propagated by the pioneers of these systems.

5.8 Elimination of Toxic Substances

Most heavy metals are toxic or cancerogenic and therefore, should not remain in the wastewater because they harm aquatic life of the receiving water, or could enter the human nutritious cycle when wastewater or sludge is used in agriculture. Since heavy metals settle easily, their removal is not difficult. Nonetheless, sludge must be dumped safely, at guarded sites.

Other toxic substances may be soluble and thus difficult to remove. There are numerous methods to eliminate or transform toxins into non-toxic matters, which cannot be described here. More specialised literature may be consulted.

Tab. 5.

Rating of noxious substances according to German law. Mercury is the most dangerous matter of this list.

Noxious Substances Units (NSU) acc. to German Federal Law 11/4942, 1989	
noxious substance group	1 NSU is equal to
oxidisable matter	50 kg COD
phosphorous	3 kg P
nitrogen	25 kg N
organic fixed halogenes	2 kg AOX
mercury	20 g Hg
cadmium	100 g Cd
chromium	500 g Cr
nickel	500 g Ni
lead	500 g Pb
copper	1000 g Cu
dilution factor for fish toxicity	3000 m ³

Imhoff pg 298

A too high salt content inhibits biological treatment in any case. Less dangerous amounts of salt are not necessarily harmless as a result of the fact that they cannot be easily removed. For example, in case of saline water used for domestic or industrial purposes, the water remains saline even after treatment. It therefore cannot be used for irrigation. It is also not allowed to enter the ground water table or receiving rivers that carry too little water. Costly ion-exchangers may have to be used to break-up the stable mineralised molecules of salts.

5.9 Removal of Pathogens

Wastewater even after treatment must be considered as being hygienically unsafe. Underground filtration and large pond systems are relatively efficient in pathogen removal but not necessarily to an extent that wastewater can be called safe for bathing - let alone drinking. However, reuse for irrigation is possible under certain conditions.

Pathogens are divided into helminth eggs, protozoal cysts, bacteria and viruses. Helminth eggs and protozoa accumulate in sediment sludge and are largely retained inside the treatment system, where they stay alive for several weeks. Most bacteria (and virus) caught in the sludge die after shorter periods. Those bacteria, which are not caught in the sludge, that remain suspended in the liquid portion are hardly affected. This is especially true of high rate reactors, like filters or activated sludge tanks. This means that such bacteria and viruses exit the plant fully alive. Although the risk of virus infection from wastewater has proved to be low.

Exposure to UV rays has a substantial hygienic effect. The highest rate of pathogen removal can be expected

from shallow ponds with long retention times, e.g. 3 ponds in a row with HRT of 8 - 10 days each. Constructed wetlands with their multifunctional bacterial life in the root zones can also be very effective. However, it is the handling after treatment, which ensures hygienic standards (see also chapter 11.).

Using chlorination to kill pathogens in wastewater is only advisable for hospitals in case of epidemics and other such special circumstances. It may also be used for instance, in the case of a slaughterhouse treatment plant that is only a short distance away from a domestic water source. Permanent chlorination is never advisable. It has an adverse impact on the environment: Water is made unsuitable for aquatic life as chlorine itself has a high chemical oxygen demand (COD).

Bleaching powder (chlorinated lime) containing approximately 25% Cl is most commonly used as source of chlorine. Granular HTH (high test hyperchlorite) containing 60 to 70% Cl is available on the market under different brand names. Since chlorination should not be a permanent practice, a chamber for batch supply, followed by a contact tank of 0,5 - 1 h HRT will be sufficient (*Fig. 11.*).

Tab. 6..

Comparing the use of chlorine for different requirements at various places

Chlorination practice				
type of infection, type of wastewater	country	dose of chlorine g/m ³	contact time h	total rest chloride mg/l
intestinal pathogens	China		> 1,0	5
tubercular pathogens	China		> 1,5	7
raw wastewater	Germany	10 - 30	0,25	traces
post treatment	India	3		
post treatment	Germany	2	0,25	traces
odour control	Germany	4	0,25	traces

Garg, Imhoff, HRIEE

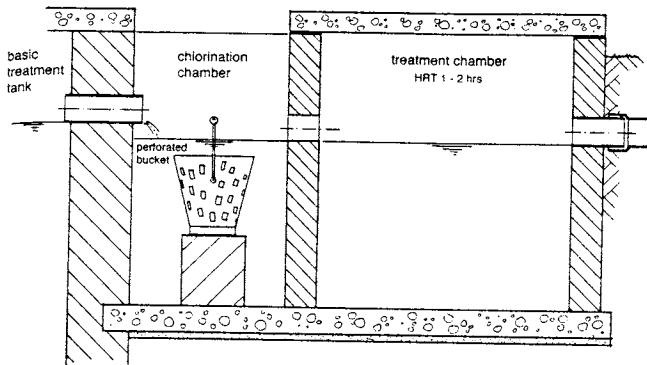

Fig. 11. Post treatment chlorination in batch chamber for small scale application. The bucket is filled with bleaching powder which is washed out automatically. This plant is acceptable for emergency disinfection of effluent from rural hospitals only, because controlled dosing is not possible.

6 ECOLOGY AND SELF PURIFICATION EFFECT

The understanding of the self-purification ability of the natural environment helps to design DEWATS intelligently. That implies that, on the one hand, only harmless wastewater is discharged, and on the other hand that nature may be incorporated into the design for completion of the treatment process.

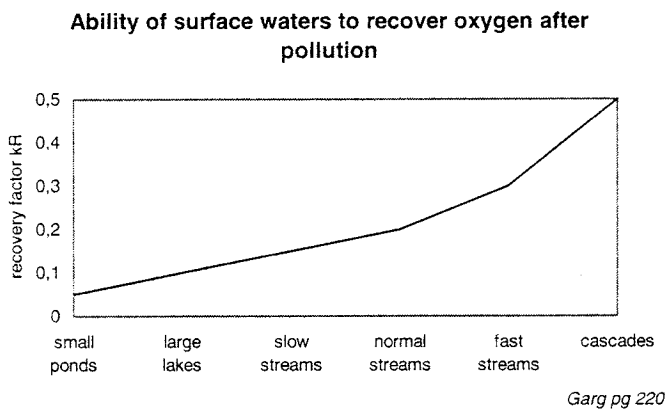

Fig. 12. Oxygen recovery after pollution of natural waters. Turbulence increases oxygen intake and reduces time for recovery.

6.1 Surface Water

The biological self-purification effect of surface waters depends on the climate, weather and on the relative pollution load in water. The presence of free oxygen is a precondition for the self-purification process. The higher the temperature, the higher the rate at which the degrading bacteria that are responsible for purification multiply. At the same time, the intake of oxygen via sur-

face and oxygen solubility drops with increasing temperature. Rain and wind, increase the oxygen intake capacity. Consequently, acceptable pollution loads or wastewater volumes must be dimensioned according to the season with the least favourable conditions (e.g. winter or summer in temperate zones, dry season in the tropics). It is difficult to reanimate water once the self-purification effect has stopped as thereafter, it enters the anaerobic stage.

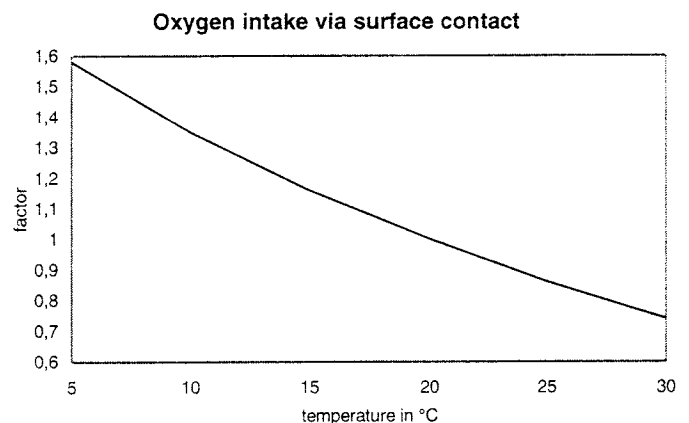

Fig. 13. Oxygen intake of natural waters reduces with rising temperature.

Extreme seasonal changes make it difficult to maintain the self-purification effect of water throughout the year. However, nature has a way of helping itself as in the case of lakes and rivers that dry-out in long dry seasons when the remains of organic matter compost and are fully mineralised before the next rains come. Minerals retain their fertilising quality even after drying. This

is why sludge at the bottom of dried lakes, canals or rivers is better brought to the fields before it is washed away into the receiving water by the first heavy rains and its rich nutrient value is lost. However, the content of toxic matter in sludge should be observed.

The most important source of oxygen for natural water in an ecosystem is oxygen from the air, which dissolves in water via surface contact. Floating fat, grease or oil films restrict oxygen transmission from air and in addition, need oxygen for their decomposition.

Nutrients descending from wastewater increase algae growth. In a healthy ecosystem, algae produce oxygen during the day and consume part of this oxygen at night. If the algae population were to become unduly dense, sunlight would not be able to penetrate the dark green water. In consequence, the algae would consume oxygen during the day as well and the supply of free oxygen that is needed for aquatic life would decrease.

The degree of pollution and more particularly the content of dissolved oxygen (DO), can be assumed from the variety of plant and animal species found in the water. The colour of the water of river and lakes is yet another indicator of the quality of the water. Green or green-brownish water is indicative of high nutrient supply due to algae, a reddish-rosy colour indicates facultative algae and is suspicious of a severe lack of free oxygen; black is often indicative of complete anaerobic conditions of suspended matter.

Nitrogen in the form of nitrate (NO_3) is the main polluting nutrient. In the form of ammonia (NH_3) it is also a major oxygen

consuming toxic substance for which reason nitrogen should be kept away from living waters; notwithstanding that nitrate may also function as an oxygen donor in certain instances.

The next most important polluting nutrient is phosphorus, which is present mostly in the form of hydrogen phosphate (H_2PO_4). Since phosphorus is often the limiting factor for the utilisation of other nutrients, its presence in surface waters is dangerous, as even in small doses it may lead to an oversupply of nutrients. Nitrogen that is normally available in plenty needs 10% of phosphorus to be of use to plants. That means phosphorus activates ten times as much nitrogen and by that effect may be considered the most polluting element to any receiving water. For the same reason is wastewater rich in phosphate a good fertiliser when used for irrigation in agriculture.

Phosphorus accumulates in closed ecosystems, e.g. in lakes. Unlike nitrogen that is eliminated, phosphorus remains potentially active in the residue of dead plants, which have consumed the element previously. For example, phosphate fixed by iron salts can be set free under anaerobic conditions in the bottom sludge, where it is available for new plant growth. It is for this reason that continuous supply of phosphate into lakes is prohibited. While it may be less dangerous for flowing waters, it must be realised that the river ends somewhere at which point phosphorus will accumulate.

While chloride may be used for disinfecting effluents from hospitals and slaughterhouses, it must be remembered that chloride does also disinfect the receiving waters thereby reducing its self-purification ability.

It is self evident that toxic substances should not enter any living water. Most toxic substances become harmless in the short term, particularly if they are sufficiently diluted. However, most toxic materials are taken in by plants and living creatures, and in the long run accumulate in the aquatic life cycle. Fish from such waters become unsuitable for human consumption. Heavy metals also accumulate in the bottom sludge of receiving waters where they remain as a time-bomb for the future.

6.2 Groundwater

Groundwater was rainwater before. It is the most important source of water for domestic use, irrigation and other purposes. The supply of ground water is not infinite. To be sustainable, it must be recharged. Rather than simply draining used water into rivers that carry it to the sea, it would be better to purify this water and use it to recharge the groundwater.

Organic pollution of groundwater happens in cases where wastewater enters underground water streams directly. A crack-free, three meters thick soil layer above groundwater is sufficient to prevent organic pollution. Pollution by mineralised matters is far more frequent, as salts like nitrate and phosphate being soluble in water cannot be eliminated by physical filtration when passing soil or sand layers. Some pathogens may also reach the groundwater despite soil filtration. Viruses can be dangerous due to their infectious potential irrespective of their absolute number.

Nitrate is easily soluble in water. Therefore, it is easily washed out from soil into groundwater, especially in sandy soil during peri-

ods when vegetation is low (e.g. winter in cold climate). Groundwater will therefore always contain a certain amount of nitrate (mostly above 10 mg/l).

Nitrate (NO_3) in its self is rather harmless. For example in the European Union, drinking water may legally contain Nitrate up to 25 mg/l. However, it is latently dangerous because it is capable of changing under certain biological or chemical circumstances to nitrite (NO_2). This process can even happen inside the human blood where nitrite is fixed at the haemoglobin, as a result of which the capacity of the haemoglobin to "transport" oxygen is reduced, leading to suffocation. Babies are especially at risk because of a greater tendency to form nitrite. This is why the water that is used for the production of baby food must always contain less than 10 mg/l NO_3 .

6.3 Soil

Soil pollution can be dangerous because of washout effects that harm surface and ground water alike. Soil itself can also be rendered useless for agriculture due to pollution. For example, the pH may drop as a result of incomplete anaerobic digestion of organic matter. This happens particularly with clay or loamy soils when oxygen supply is insufficient due to the physical closure of the pores in the soil by suspended solids from wastewater irrigation.

Mineral salts in small doses are normally not a problem for wastewater treatment. Nonetheless, using saline wastewater for irrigation over a long period of time may cause complete and irreversible salination

of the topsoil. Clay and loamy soil with slow downward percolation is most affected, because when water evaporates the salt remains on top of the soil.

On the other hand, sandy soils may benefit from irrigation with wastewater even when the organic load is high, on the condition that oxygen can be supplied to deeper soil layers. Well treated wastewater which contains mineralised nitrogen, phosphorus and other trace elements may im-

prove soil conditions and is environmentally safe as long as the application of nutrients is balanced with its in-take by plants. Application of treated wastewater throughout the year regardless of demand may have adverse effects. This happens because the nutrients are washed out into water bodies at times when plant growth is negligible, with the result that nutrients are not available to the plants when needed.

7 CONTROL PARAMETERS

Laboratory analysis is used to understand the quantity and quality of the pollution load, the feasibility of treatment, the environmental impact and the potential of a certain wastewater for biogas production. Some properties can even be seen and understood by experienced observation. Detailed analysing techniques may be found in books for laboratory work or comprehensive handbooks on wastewater, like *Metcalfe & Eddy's "Wastewater Engineering"*.

As the quality of wastewater changes according to the time of the day and from season to season, the analysis of data is never absolute. It is far more important to understand the significance of each parameter and its "normal" range than to know the exact figures. Ordinarily, an accuracy of $\pm 10\%$ is more than sufficient.

7.1 Volume

The volume or the flow rate of a particular wastewater determines the required size of the building structure, upon which the feasibility or suitability of the treatment technology is decided. Therefore, this is the first information a wastewater engineer needs to know (see chapter 8.1).

Surprisingly, the determination of flow is rather complicated and is often difficult to execute, due to the fact that flow rates change during the daytime or with seasons, and that volumes have to be measured in „full size“. It is not possible to take a sample which stand for the whole. In case of DEWATS, it is often easier and more practi-

cal to measure or inquire into the water consumption instead of trying to measure the wastewater production. The flow of wastewater is not directly equal to water consumption since not all the water that is consumed ends up in the drain (e.g. water for gardening), and because wastewater might be a mix of used water and storm water. Stormwater should be segregated from the treatment system as far as possible especially if it is likely to carry substantial amounts of silt or rubbish. Rainwater drains should certainly never be connected to the treatment plant. However, ponds and ground filters will be exposed to rain. The volume of water in itself is normally not a problem since hydraulic loading rates are not likely to be doubled and in fact, a certain flushing effect could even be advantageous. Soil clogging (silt-ing) could become a problem, if stormwater reaches the filter after having eroded the surrounding area.

For high rate reactors, like anaerobic filters, baffled septic tanks and UASB, the flow rate per hour could be a crucial design parameter. If exact flow data is not available, the hours per day which account for most of the flow, may be considered. This should be read together with hydraulic retention times in appreciation of the fluctuation influence.

Collected volumes per time can be used to measure flow rates. This may be the rise in level of a canal that is closed for a period of time, or the number of buckets filled during a given period. A good indicator of actual flow rate is also the time it takes

during initial filling until the first tank of a treatment plant overflows.

In larger plants the flow rates are normally measured with control flumes (e.g. Parshall flume) where rise in level before a slotted weir indicates the flow.

7.2 Solids

Total Solids (TS) or dry matter (DM) include all matter, which is not water. Organic total solids (OTS) or volatile solids (VS) are the organic fraction of the total solids. TS is found by drying the sample, the inorganic fraction is found by burning, where it remains as ash. TS minus ash is OTS or VS. Solids may be measured in mg/l or in percentage of the total volume.

The parameter "suspended solids" (SS) describes how much of organic or inorganic matter is not dissolved in water. Suspended solids include settleable solids and non-settleable suspended solids. Settleable solids sink to the bottom within a short time. They can be measured with standardised procedure in an Imhoff-cone, in relation to a defined settling time of 30 minutes, 1 hour, 2 hours or one day. Measurement of settle-

able solids is the easiest method of wastewater analysis because solids are directly visible in any transparent vessel. For the first on-site information, any transparent vessel will do (e.g. water bottles - which should be destroyed after use for hygienic safety).

Non-settleable suspended solids consist of particles, which are too small to sink to the bottom within a reasonable (technical) time. SS is detected by filtration of a sample. Suspended solids are an important parameter because they cause turbidity in the water and may cause physical clogging of pipes, filters, valves and pumps.

Colloids are very fine suspended solids ($< 0,1 \mu\text{m}$) which pass normal filtration paper but are not fully dissolved in water (dissolved solids are single molecules that are spread-out among the water molecules). A high percentage of fatty colloids can be a real problem in fine sand filters.

In domestic wastewater, approximately, the BOD derives to 1/3 (33%) from settleable solids, to 1/2 (50%) from dissolved solids, while 1/6 (17%) of the BOD derives from non-settleable SS (*Tab. 12.*).

Tab. 7.

Domestic wastewater derives from various sources. Composition of wastewater depends highly on standard of living and domestic culture.

Total solids components of "modern" domestic wastewater		
range source	min g/cap*d	max g/cap.*d
feces (solids, 23%)	32	68
ground food wastes	32	82
wash waters	59	100
toilet (incl. paper)	14	27
urine (solids, 3.7%)	41	68

Metcalf&Eddy, pg 164

7.3 Fat, Grease and Oil

Fat and grease are organic matters which are biodegradable. However, since they float on water and are sticky in nature their physical properties are a problem in the treatment process and in nature. It is best to separate fat and grease before biological treatment.

The fat that remains in treated domestic wastewater is normally low. A fat content of approximately 15 - 60 mg/l is allowed in the

effluent of slaughter houses or meat processing plants for discharge into surface water. Mineral grease and mineral oils like petrol or diesel although they may also be treated biologically should be kept away from the treatment system. Their elimination is not within the scope of DEWATS.

7.4 Turbidity, Colour and Odour

Most wastewaters are turbid because the solids suspended in them break the light. Therefore, highly turbid fluid indicates a high percentage of suspended solids. *Metcalf & Eddy* (pg 257) gives the relation between turbidity and suspended solids with the following equation

$$\text{SS [mg/l]} = 2,35 \times \text{turbidity (NTU)}, \text{ or} \\ \text{turbidity (NTU)} = \text{SS [mg/l]} / 2,35$$

NTU is the standardised degree of turbidity. This can be determined with the help of a turbidimeter or by standardised methods by which the depth of sight of a black cross on a white plate is measured.

Turbidity may cause the algae in surface waters not to produce oxygen during daytime, as would otherwise be the case.

The colour is not only indicative of the source of wastewater but is also indicative of the state of degradation. Fresh domestic wastewater is grey while aerobically degraded water tends to be yellow and water after anaerobic digestion becomes blackish. Turbid, black water may be easily settleable because suspended solids sink to the bottom after digestion when given enough undisturbed time to form flocs. A brownish colour is telling of incomplete aerobic or facultative fermentation.

Wastewater that does not smell probably contains enough free oxygen to restrict anaerobic digestion or the organic matter has long since been degraded. A foul smell ("like rotten eggs") comes from H₂S (hydrogen sulphur) which is produced during anaerobic digestion, especially at a low pH. Ergo, a foul smell means that free oxygen is not available and that anaerobic digestion is still under way. Vice versa, whenever there is substantial anaerobic digestion there will always be a foul smell.

Other odours are related to fresh wastewater from various sources. Experience is the best basis for conclusions: Dairy wastewater will smell like dairy wastewater, distillery wastewater will smell like distillery wastewater, etc., etc.. However, to „smell the performance“ of a treatment plant is most important. A wastewater engineer should be alert and „collect“ various odours and its causes, to build up a repertoire of experience for future occasions.

7.5 COD and BOD

Of all parameters, the COD (Chemical Oxygen Demand) is the most general parameter to measure organic pollution. It describes how much oxygen is required to oxidise all organic and inorganic matter found in water. The BOD (Biochemical Oxygen Demand) is always a fraction of the COD. It describes what can be oxidised biologically, this is with the help of bacteria. It is equal to the organic fraction of the COD. Under standardised laboratory conditions at 20°C it takes about 20 days to activate the total carbonaceous BOD (=BOD_{ultimate}, BOD_{total}). In order to save time, the BOD analysis stops after 5 days. The result is named BOD₅, which is simply called the

BOD, in practice. The BOD_5 is a certain fraction (approximately 50 to 70%) of the absolute BOD. This fraction is different for each wastewater. The ratio of BOD_{total} to BOD_5 is wider with difficult degradable wastewater, and thus, it is also wider with partly treated wastewater.

COD and BOD are the results of standardised methods used in laboratory analysis. They do not fully reflect the bio-chemical truth, but are reliable indicators for practical use. Biological oxygen demand is a practical description of that portion which can be digested easily, e.g. anaerobically. The COD/BOD_{total} vaguely indicates the relation of total oxidisable matter to organic matter, which is first degraded by the most common bacteria. For example, if a substrate is toxic to bacteria, the BOD is zero; the COD nonetheless may be high as it would be the case with chlorinated water. In general, if the COD is much higher than the BOD (>3 times) one should check the wastewater for toxic or non-biodegradable substances. In practice, the quickest way to determine toxic substances is to have a look into the shopping list of the institution which produces the wastewater. What kind of detergent is bought by a hospital may be more revealing than a wastewater sample taken at random.

However, one should know that the COD in a laboratory test shows the oxygen donated by the test-substance, which is normally K_2Cr_2O (potassium dichromate). The tested substrate is heated to mobilise the chemical reaction (combustion). Sometimes $KMnO_4$ (potassium permanganate) is used for quick on-site tests. The COD_{cr} is approximately twice as much as the COD_{Mn} . It should be noticed that the two do not have a fixed relation that is valid for all wastewaters.

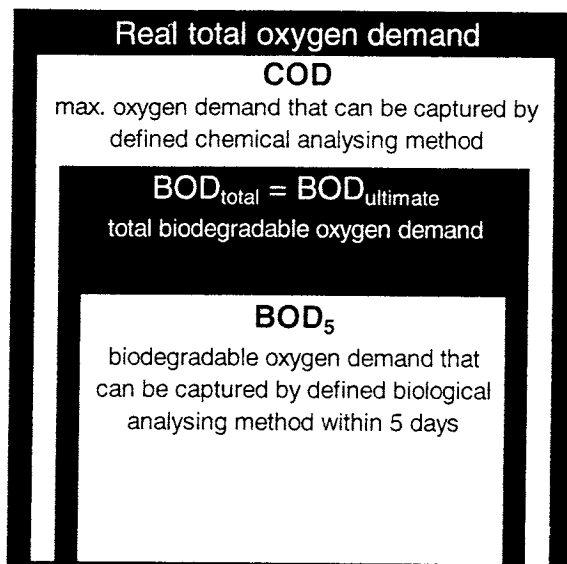

COD and BOD_5 are not in any case comparable to each other.

Fig. 14.

Definition of oxygen demand. The BOD_5 is a part of the total BOD, the total BOD may be understood as part of the COD and the COD is part of the absolute real oxygen demand. The total BOD may be equal to the COD; the COD may be equal to the real oxygen demand.

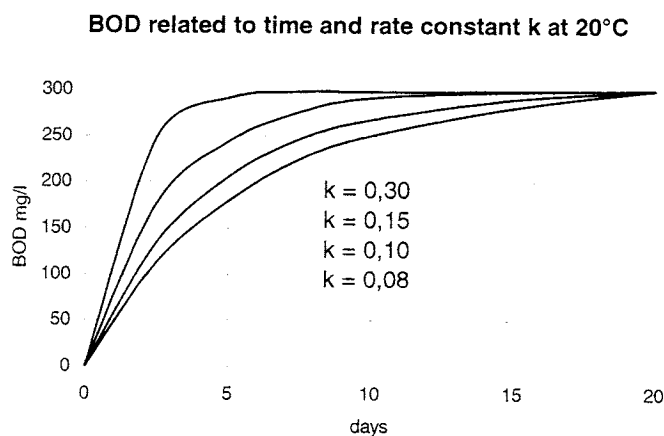

Fig. 15.

BOD removal rates are expressed by rate constants (k) which depend on wastewater properties, temperature and treatment plant characteristics. The curve shows the BOD removal rates at 20°C. The value after 5 days is known as BOD_5 .

Easily degradable wastewater has a COD/BOD₅ relation of about 2. The COD/BOD ratio widens after biological, especially anaerobic treatment, because BOD is biologically degradable. COD and BOD concentrations are measured in mg/l or in g/m³. Absolute values are measured in g or kg. A weak wastewater from domestic sources for example, may have a COD below 500 mg/l while a strong industrial wastewater may contain up to 80.000 mg/l BOD.

Concentrations toxic to the anaerobic process	
toxic metal	concentration mg/l
Cr	28-200
Ni	50-200
Cu	5-100
Zn	3-100
Cd	70
Pb	8-30
Na	5000-14000
K	2500-5000
Ca	2500-7000
Mg	1000-1500

Mudrak / Kunst pg. 158

Tab. 8.
Concentration of toxic substances which inhibit anaerobic digestion

Too much BOD or COD discharged into surface water could mean that the oxygen present in that water will be used for decomposition of the pollutants, and thus, is not anymore available for aquatic life. Effluent standards for discharge into receiving waters may tolerate 30 to 70 mg/l BOD and 100 to 200 mg/l COD.

Total organic carbon (TOC) is sometimes mentioned. This is an indication of how much of the COD relates to the carbon only. In the case of DEWATS, knowledge of BOD or COD is sufficient, TOC is of no practical concern.

7.6 Nitrogen (N)

The different forms in which nitrogen is found in wastewater is a good indicator of what happens or what has already happened during treatment. Nitrogen is a major component of proteins (albumen). A high percentage of albuminoid nitrogen indicates fresh wastewater. During decomposition, when large protein molecules are broken up into smaller molecules, nitrogen is found in the form of free ammonia (NH₃). However, ammonia dissolves in water and at low pH level forms ammonium (NH₄⁺). At a pH level above 7, NH₄⁺ remains as - or transforms to - NH₃. There is always a mass balance between NH₃ and NH₄. NH₃ evaporates into the atmosphere, which in case of irrigation may lead to unwanted nitrogen losses. Ammonium further oxidises to nitrite (NO₂⁻) and finally to nitrate (NO₃⁻).

From the chemical symbol, it is evident that ammonia (or ammonium) will consume oxygen to form nitrate, the most stable end product. The albuminoid and the ammonia nitrogen together form the organic nitrogen or more specifically: the Kjeldahl-N (N_{kjel}). The total nitrogen (N_{total}) is composed of N_{kjel} (non oxidised N) and nitrate-N (oxidised N).

Pure nitrogen hardly dissolves in water as a result of which it evaporates immediately into the atmosphere, a fact that is used to remove nitrogen from wastewater in the process of denitrification. Pure nitrogen (N₂) is formed when oxygen is separated from NO₃ to oxidise organic mater. Nitrification (under aerobic conditions) followed by denitrification (under anoxic conditions) is the usual process of removing nitrogen from wastewater (see chapter 5.6).

For optimum bacteria growth the relation BOD/N should be in the range of 15 to 30 in untreated wastewater.

Nitrogen is normally not controlled in effluent of smaller plants. Discharge standards for effluent of larger plants allow $N_{\text{Kjel-N}}$ in the range of 10 - 20 mg/l.

7.7 Phosphorus

Phosphorus (P) is an important parameter in case of unknown wastewater, especially in relation to the BOD, the nitrogen or the sulphur. An approximate relation of BOD/P = 100, or N/P = 5 is required for bacterial growth. Bacterial activity will be less when there is phosphorus deficiency and thus, removal of COD (BOD) will also be less.

On the other hand, very high phosphorus content in the effluent leads to water pollution caused by algae growth. However, phosphorus removal in DEWATS is hardly worth influencing and is therefore the least important parameter to the engineer. Discharge standards for larger plants allow P in the range of 1 - 5 mg/l.

7.8 Temperature and pH

Temperature is important because bacterial growth increases with higher temperature, principally, limits notwithstanding. Due to low energy gains as a result of "incomplete" anaerobic decomposition, aerobic processes are less sensitive to low temperatures than anaerobic processes. This is obvious from the fact that biogas is still oxidisable and is therefore an energy-rich end product. Temperatures between 25° and 35°C are most ideal for anaerobic diges-

tion. 18° to 25°C is also good enough. In short, a digester temperature above 18°C is acceptable in principal. The ambient temperature in tropical and subtropical zones is almost ideal for anaerobic treatment and as such is not problematic to DEWATS.

Higher temperatures are also favourable for aerobic bacteria growth, but are disadvantageous for oxygen transfer (*Fig. 13.*). The cooler the environment the more oxygen can be dissolved in water and thereby, more oxygen will be absorbed from the air. This is the reason why ponds may become anaerobic in the height of summer.

The pH indicates whether a liquid is acidic or alkaline. The scientific definition of the pH is rather complicated and of no interest to practical engineering (it indicates the H^+ ion concentration). Pure water has a pH of 7, which is considered to be neutral. An effluent of neutral pH is indicative of optimum treatment system performance. Wastewater with a pH below 4 to 5 (acidic) and above 9 (alkaline) is difficult to treat; mixing tanks may be required to buffer or balance the pH level. In case of a high pH, ammonia-N dominates, whereas as ammonium-N is prevalent in case of low pH.

7.9 Volatile Fatty Acids

Volatile fatty acids (VFA) are used as a parameter to check the state of the digestion process. A high amount of VFA always goes together with a low pH. Fatty acids are produced at an early stage of digestion. The presence of too many fatty acids indicates that the second stage of digestion which breaks up the fatty acids, is not keeping pace with acidification. The reason for this could be that the retention time is too short

or the organic pollution load on the treatment system is too high. Values of VFA inside the digester in the range of BOD_{inflow} values indicate a stable anaerobic process.

7.10 Dissolved Oxygen

Dissolved oxygen (DO) describes how much oxygen is freely available in water. This pa-

rameter indicates the potential for aerobic treatment and is sometimes used in advanced wastewater treatment. DO is more common to judge surface water quality, because it is important to aquatic life. For fish breeding, 3 mg/l DO is the minimum required and it is only sufficient for "ground fishes". For most others fishes, 4 to 5 mg/l at the minimum is required for survival.

Tab. 9. Wastewater transmitted diseases and their symptoms

Diseases and symptoms caused by pathogens in wastewater	
Organism	Disease / Symptoms
Virus (lowest frequency of infection)	
polio virus	poliomyelitis
coxsackie virus	mengitis, pneumonia, hepatitis, fever, common colds, etc.
echo virus	mengitis, paralysis, encephalitis, fever, common colds, diarrhea, etc.
hepatitis A virus	infectious hepatitis
rota virus	acute gastroenteritis with severe diarrhea
norwalk agents	epidemic gastroenteritis with severe diarrhea
reo virus	respiratory infections, gastroenteritis
Bacteria (lower frequency of infection)	
<i>salmonella spp.</i>	salmonellosis (food poisoning), typhoid fever
<i>shigella spp.</i>	bacillary dysentery
<i>yersinia spp.</i>	acute gastroenteritis, diarrhea, abdominal pain
<i>vibro cholerae</i>	cholera
<i>campylobacter jejuni</i>	gastroenteritis
<i>escherichia coli</i>	gastroenteritis
Helminth Worms (high frequency of infection)	
<i>ascari lumbricoides</i>	digestive disturbance, abdominal pain, vomiting, restlessness
<i>ascaris suum</i>	coughing, chest pain, fever
<i>trichuris trichiura</i>	abdominal pain, diarrhea, anemia, weight loss
<i>toxocara canis</i>	fever, abdominal discomfort, muscle aches, neurological symptoms
<i>taenia saginata</i>	nervousness, insomnia, anorexia, abdominal pain, digestive disturbance
<i>taenia solium</i>	nervousness, insomnia, anorexia, abdominal pain, digestive disturbance
<i>necator americanus</i>	hookworm disease
<i>hymenolepis nana</i>	taeniasis
Protozoa (mixed frequency of infection)	
<i>cryptosporidium</i>	gastroenteritis
<i>entamoeba histolytica</i>	acute enteritis
<i>giardia lamblia</i>	giardiasis, diarrhea, abdominal cramps, weight loss
<i>balantidium coli</i>	diarrhea, dysentery
<i>toxoplasma gondii</i>	toxoplasmosis

various sources, after EPA, Winblad

7. 11 Pathogens

The World Health Organisation (WHO) distinguishes between high-risk transmission of intestinal parasites (helminths eggs), and the relatively lower risk transmission of diseases caused by pathogenic bacteria. The number of helminths eggs and the number of faecal coliformes are indicative of these risks. For uncontrolled irrigation less than 10.000 e-coli per litre and less than 1 helminth egg is permitted by WHO standard. E-coli bacteria are not pathogenic but used as an indicator of faecal bacteria.

Regardless of the number of ova, bacteria or viruses, wastewater is unsafe to man. Exact pathogen counts are of limited importance for DEWATS. Bacterial or helminth counts may become important when wastewater is discharged into surface waters that are used for bathing, washing, or irrigation.

Domestic wastewater and effluents from meat processing plants and slaughterhouses that carry the risk of transmitting blood-borne diseases, like hepatitis, are particularly dangerous. Handling and discharge of such effluents may demand special precautions.

8 DIMENSIONING PARAMETERS

8.1 Hydraulic Load

The hydraulic load is the most common parameter for calculating reactor volumes. It describes the volume of wastewater to be applied per volume of reactor, or per surface of filter in a given time. The most common dimensions for reactors are $\text{m}^3/\text{m}^3 \times \text{d}$, which means 1 m^3 of wastewater is applied per 1 m^3 of reactor volume per day. The reciprocal value denotes the hydraulic retention time (HRT). For example, 1 m^3 wastewater on 3 m^3 of reactor volume gives a hydraulic load of $0.33 \text{ m}^3/\text{m}^3 \times \text{d}$, which is equal to a hydraulic retention time of 3 days (3 m^3 volume / 1 m^3 of water per day).

The hydraulic retention time (HRT) indicates a volume by volume relation. It does not for example, distinguish between sludge and liquid. The hydraulic retention time in a septic tank does not say anything about the fraction of the wastewater which stays longer inside the tank, nor it does say anything about the time that the bottom sludge has for digestion. In case of vessels filled with filter media, the actual hydraulic retention time depends on the pore space of the media. For example, certain gravel consists of 60% stones and 40% of the space between the stones. A retention time of 24 hours per gross reactor volume is reduced to only 40%, which gives a net HRT of only 9.6 hours.

For groundfilters and ponds, the hydraulic loading rates may be measured by $\text{m}^3/\text{ha} \times \text{d}$, $\text{m}^3/\text{m}^2 \times \text{d}$ or $\text{l}/\text{m}^2 \times \text{d}$. These values may also be given in cm or m height of water cover on a horizontal surface. For example, 150

litres of water applied per square meter of land is equal to $0.15 \text{ m}^3/\text{m}^2$, which in turn is equal to 0.15 m or 15 cm hydraulic load.

Hydraulic loading rates are also responsible for the flow speed (velocity) inside the reactor. This is of particular interest in case of up-flow reactors, like UASB or the baffled septic tank where the up-flow velocity of liquid must be lower than the settling velocity of sludge particles. In such cases, the daily flow must be divided by the hours of actual flow (peak hour flow rate). For calculating the velocity in an up-flow reactor the wastewater flow per hour is divided by the surface area of the respective chamber ($V = Q/A$; velocity of flow equals flow divided by area). This means that the up-flow velocity increases when a given reactor volume is split up into several chambers. This is because the flow rate per hour remains the same while the surface area of the individual chamber is reduced to only a fraction of the area of the total volume. The necessity to keep velocity low leads to relatively large digester volumes, especially in large sized baffled septic tanks.

8.2 Organic Load

For strong wastewater, the organic loading rate and not the hydraulic loading rate becomes the determining parameter. Calculation is done in grams or kilograms of BOD_5 (or COD) per m^3 digester volume per day in case of tanks and deep anaerobic ponds. For shallow aerobic ponds the organic loading is related to the surface with the dimen-

sions g/m² or kg/ha BOD (or COD). The permitted organic loading rate depends on the kind of reactor, the reactor temperature and the kind of wastewater. The organic loading rate takes care of the time which the various kinds of bacteria need for their specific metabolism (often expressed as rate constant k). Organic loading influences a co-ordinated follow up of different treatment steps. Easily degradable substrate can be fed at higher loading rates, because all the bacteria involved multiply fast and consume organic matter quickly. For difficult degradable substrate, some of the bacteria species need a longer time.

Organic loading rates may not destabilise the process, it does reduce the overall efficiency of the treatment process.

8.3 Sludge Volume

The volume of sludge is an important parameter for designing sedimentation tanks and digesters. This is because the accumulating sludge occupies tank volume that must be added to the required reactor volume. Biological sludge production is in direct relation to the amount of BOD removed, which however, depends on the decompo-

Tab. 10.

Organic loading rates and removal efficiencies of various treatment systems

Organic loading rates, treatment efficiency and optimum temperature						
typical values	aerobic pond	maturation pond	water hyacinth pond	anaerobic pond	anaerobic filter	baffled reactor
BOD ₅ kg/m ³ *d	0,11	0,01	0,07	0,3 - 1,2	4,00	6,00
BOD ₅ removal	85%	70%	85%	70%	85%	85%
temperature optimum	20°C	20°C	20°C	30°C	30°C	30°C

mixed sources

At too high loading rates it might be possible that the end products from one step of fermentation cannot be consumed by the group of bacteria that follow. This might lead to "poisoning" and collapse of the process. For instance, in anaerobic digestion, the fatty acids produced in the first step have to be consumed by the group of bacteria that follow. Otherwise, the substrate turns sour and final methanisation cannot take place.

At loading rates that are too low, little bacterial sludge is produced, because the bacteria "eat each other" for want of feed (autolysis). Consequently, incoming wastewater does not meet with sufficient bacteria for decomposition. Nonetheless, while low or-

sition process. Aerobic digestion produces more sludge than anaerobic fermentation. In addition to the biological sludge, primary sludge consists partly of sludge that is already mineralised.

The standard wastewater literature describes sludge volumes from different treatment systems; some of which is not comparable to DEWATS. In conventional sewage treatment works, the sludge is removed continuously and often under water. This produces a very liquid sludge with a low total solid content that varies between 1 and 5 %. In DEWATS, the sludge remains inside the tank for at least one year where it decomposes under anaerobic conditions. It also compacts with resting time, under its own weight.

Tab. 11.

Average distribution of solids of domestic wastewater in Germany

Solids content of domestic wastewater								
	mineral dry matter		organic dry matter		total dry matter		BOD ₅	
	g/cap.*d	g/m ³	g/cap.*d	g/m ³	g/cap.*d	g/m ³	g/cap.*d	g/m ³
settleable solids	20	100	30	150	50	250	20	100
suspended solids	5	25	10	50	15	75	10	50
dissolved solids	75	375	50	250	125	625	30	150
Total	100	500	90	450	190	950	60	300

Imhoff pg 103, 104

Literature reports vary widely on the volumes of sludge, which accumulate over time in primary treatment tanks. *Garg* cites 30 l per capita per year for septic tanks in India, while *Metcalf & Eddy* quote 140 l per capita per year for Imhoff tanks in the USA which is comparable to Chinese standard of 0.4 l per capita per day. Reports suggest, sludge volumes in the range of 360 to 500 litres per capita per annum in settlers of conventional treatment systems. *Imhoff* claims 1.8 litre per capita per day for fresh settled sludge that after anaerobic digestion is reduced to 0.3 litres per day or 110 litres per annum. This volume is further reduced after dewatering to 0.1 litre per capita per day. *Inamori* for an instance, has found 3.35 kg of sludge solids accumulated per capita per year in a pre-fabricated septic tank in Japan. Assuming a total solids content of compressed anaerobic bottom sludge of 11%, this corresponds closely with the 30 litres reported by *Garg* which may be further reduced with increased desludging intervals.

To obtain an approximate figure in relation to the BOD load of any wastewater, these 30 litres of sludge per annum are related to approximately 15 - 20 g BOD removed in the septic tanks per day. This means 0.005

litres of sludge per gram BOD_{removed} accumulate in the primary treatment step of DEWATS which also includes a certain percentage of mineral settleable particles that no longer appear in the secondary treatment step. Furthermore, not all digested organic matter accumulates as settleable sludge in the secondary treatment part. A value of 0.0075 litres is taken for oxidation ponds because of additional sludge from algae.

Tab. 12.

Properties of primary sludge

Properties of sludge from primary sedimentation		
specific gravity of solids	specific gravity of sludge	dry solids
kg/l	kg/l	g/m ³
1,4	1,02	150,6

Metcalf & Eddy, pg. 773

The above figures are valid for „modern“ domestic wastewater as described in **Tab. 11**.

Sludge accumulation from other wastewater with different settling properties and different relations between organic and mineral matter content may be calculated in the same manner as explained above keeping in mind however, their particular properties.

9 TECHNOLOGY

9.1 Grease Trap and Grit Chamber

In case there is a septic tank provided, DEWATS normally does not require grease traps or grit chambers for domestic wastewater. Whenever possible it is better to avoid them altogether, because grease and grit must be removed, at least weekly. However, for canteens or certain industrial wastewaters it may be advisable to separate grit and grease before the septic tank.

The function of grease and grit chamber is comparable to that of the septic tank, namely light matter should float and heavy matter should sink to the bottom. The difference is that bio-degradable solids should have no time to settle. Therefore, retention times for grit chambers are short - about 3 minutes only - and for that reason are masonry structures not appropriate in case of minor flows.

A conical trough allows slow flow at a large surface for grease floatation and fast flow at the narrow bottom which allows only heavy and coarse grit to settle. The water surface is protected from the turbulence of the inflow by a baffle; the outlet is near the bottom.

9.2 Septic Tank

The septic tank is the most common, small scale and decentralised treatment plant, worldwide. It is compact, robust and in comparison to the cost of its construction, extremely efficient. It is basically a sedimentation tank in which settled sludge is stabilised by anaerobic digestion. Dissolved and suspended matter leaves the tank more or less untreated.

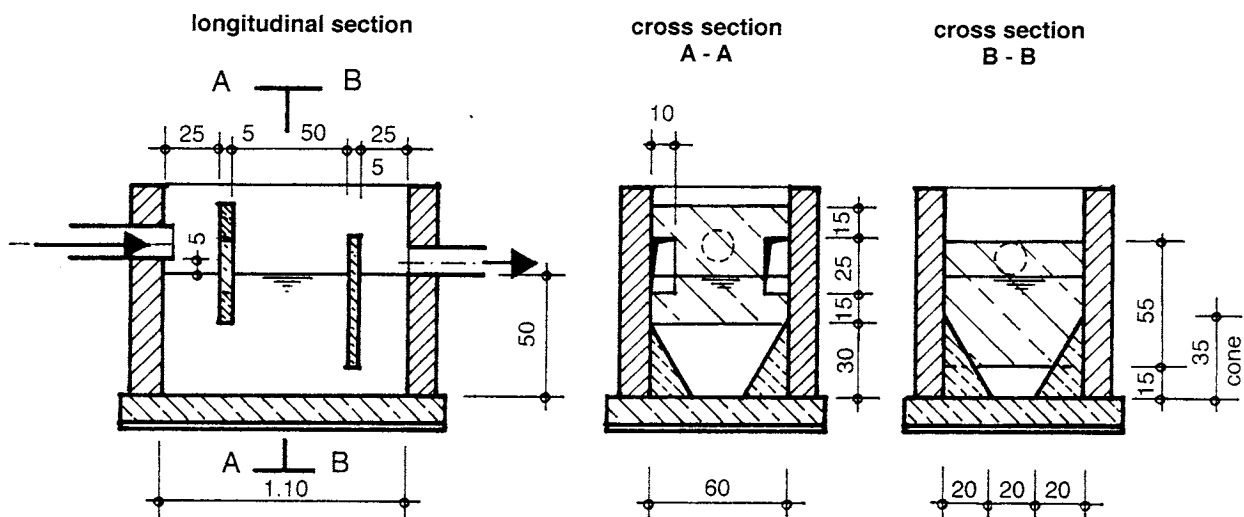

Fig. 16.

Principle design of combined grease trap and grit chamber. Accumulating grease, oil and grit may be removed daily, at least weekly. If this is not assured, an oversized septic tank is preferable to receive grit and grease.

Two treatment principles, namely the mechanical treatment by sedimentation and the biological treatment by contact between fresh wastewater and active sludge compete with each other in the septic tank. Optimal sedimentation takes place when the flow is smooth and undisturbed. Biological treatment is optimised by quick and intensive contact between new inflow and old sludge, particularly when the flow is turbulent. The way the new influent flows through the tank decides which treatment effect predominates.

With smooth and undisturbed flow, the supernatant (the water remaining after settleable solids have separated) leaves the septic tank rather fresh and odourless, implying that degradation has not started yet. With turbulent flow, degradation of suspended and dissolved solids starts more quickly because of intensive contact between fresh and already active substrate. However, since there is not enough „calmness“ for sedimentation, more suspended solids are discharged with the effluent due to the turbulence. The effluent stinks because active solids that are not completely fermented leave the tank.

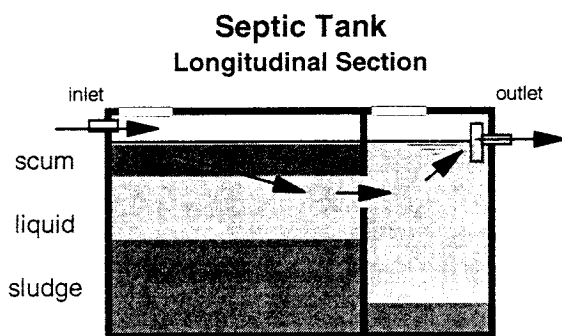

Fig. 17. Flow principle of the septic tank. Most sludge and scum is retained in the first chamber; the second chamber contains only little sludge which allows the water to flow undisturbed by rising gas bubbles.

In domestic wastewater, a heavy scum consisting of matters lighter than water such as fat, grease, wood chips, hair or any floating plastics normally forms near the inlet. A larger portion of the floating scum consists of sludge particles which are released from the bottom and driven to the top by treatment gases. New sludge from below lifts the older scum particles above the water surface where they become lighter due to drying. Therefore, scum accumulates and must be removed regularly, at least every third year. Scum does not harm the treatment process as such, but it does occupy tank volume.

A septic tank consists minimum of 2, sometimes 3 compartments. The compartment walls extend 15 cm above liquid level. They may also be used as bearing walls for the covering slab if some openings for internal gas exchange are provided.

The first compartment occupies about half the total volume because most of the sludge and scum accumulates here. The following chamber(s) are provided to calm the turbulent liquid. They are made of equal size and in total, occupy the other half of the volume. All chambers are normally of the same depth. The depth from outlet level to the bottom may be between 1.50 m and 2.50 m. The first chamber is sometimes made deeper.

The size of the first chamber is calculated to be at least twice the accumulating sludge volume. The sludge volume depends on the portion of settleable solids of the influent and on desludging intervals (*Fig. 67*). Most countries provide a National Standard for tank volume per domestic user.

The SS removal rate drops drastically when accumulated sludge fills more than $2/3$ of

the tank. This must be avoided; especially in cases where the effluent is treated further in a sand or gravel filter.

"Irregular emptying of septic tanks leads to irreversible clogging of the infiltration bed; rather than renewing the bed, most owners by-pass it and divert the tank's effluent to surface drains."

(Alaerts, G.J., Veenstra, S., Bentvelsen, M., van Duijl, L.A. at al.: "Feasibility of anaerobic Sewage Treatment in Sanitation Strategies in Developing Countries")

For domestic sewage, the accumulating sludge volume should be calculated at $0.1 \text{ L/cap} \times \text{d}$. When desludging intervals are longer than 2 years, the sludge volume may be taken to $0.08 \text{ L/cap} \times \text{d}$ as sludge gets compacted with time (see figure Fig. 67.).

The inlet may dive down inside the tank, below the assumed lowest level of the scum or may be above the water level when the inlet pipe is used to evacuate gas. The ventilation pipe for digester gases should end outside buildings, at a minimum of 2 m above the ground.

The connection between compartments is done by simple wall openings that are situated above the highest sludge level and below the lowest level of the scum. This for domestic wastewater, would mean that the top of the opening is 30 cm below outlet level and its bottom is at least half the water depth, above the floor. The openings should be equally distributed over the full width of the tank in order to minimise

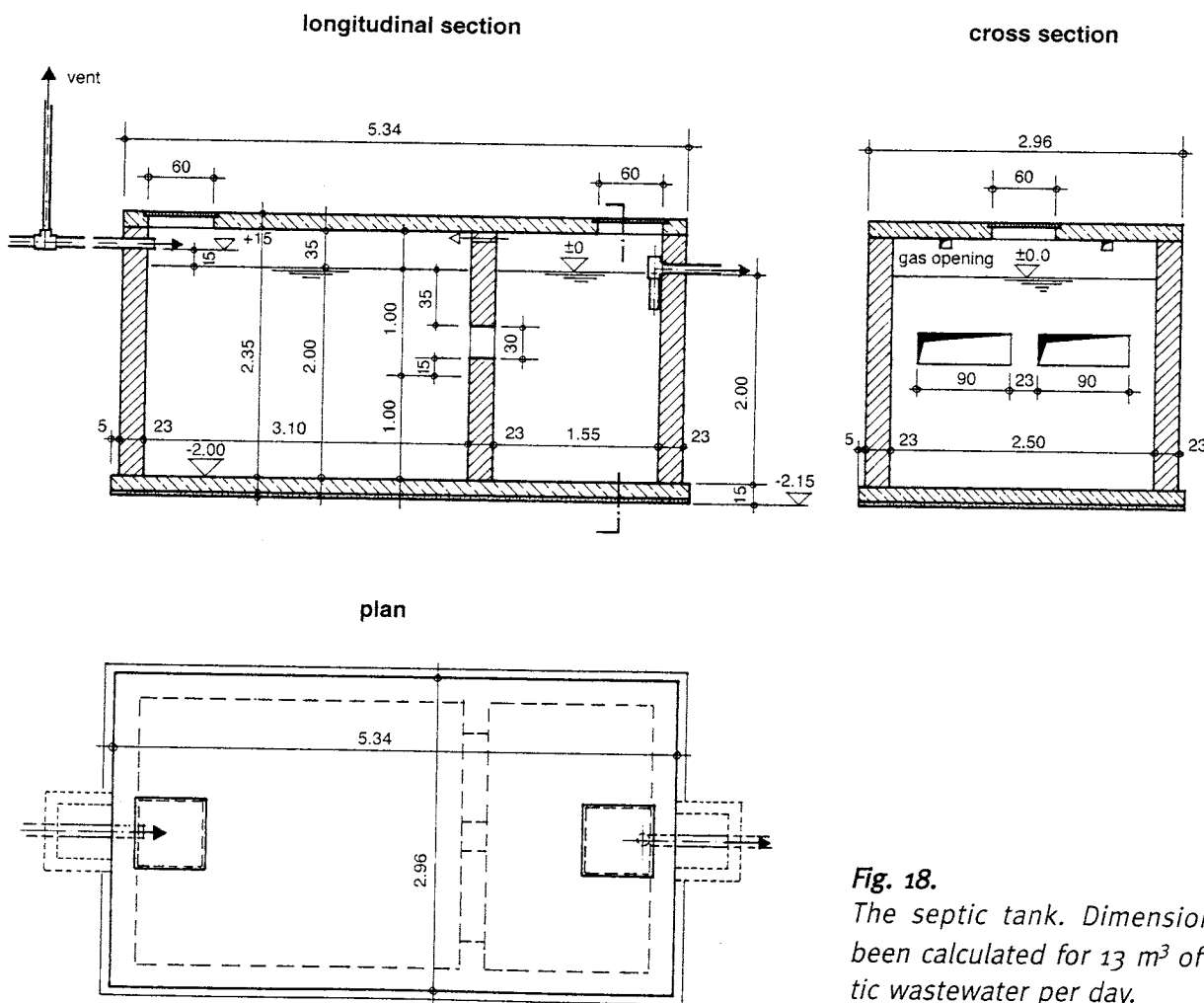

Fig. 18.
The septic tank. Dimensions have been calculated for 13 m^3 of domestic wastewater per day.

turbulence. A slot spanning the full width of the tank would be best for reducing velocity, which would otherwise cause turbulence.

Nothing gets lost; even treated water must go somewhere.

The septic tank is a biogas plant, the biogas of which is not used. However, gas accumulates inside the tank above the liquid, from where it should be able to escape into the air. For this reason, an open fire should be avoided when opening the septic tank for cleaning.

The outlet has a T-joint, the lower arm of which dives 30 cm below water level. With this design, foul gas trapped in the tank enters the sewage line from where it must be ventilated safely. If ventilation cannot be guaranteed, an elbow must be used at the outlet to prevent the gas from entering the outlet pipe.

There should be manholes in the cover slab; one each above inlet and outlet and one at each partition wall, preferably at the inlet of each compartment. The manholes should be placed in such a manner to make the drawing of water samples from each compartment possible.

Septic tanks were originally designed for domestic wastewater. They are also suitable for other wastewater of similar properties, particularly those that contain a substantial portion of settleable solids.

The treatment quality of a septic tank is in the range of 25% - 50% COD removal. This is a rough, primary treatment prior to secondary or even tertiary treatment. Post treatment may be provided in ponds or ground

filters. In case of the latter, regular desludging of septic tanks is mandatory. A septic tank may also be integrated into an anaerobic filter or it could be the first section of a baffled reactor. Septic tanks are suitable as individual on-site pre-treatment units for community sewer systems, because the diameter of sewerage can be smaller when settleable solids have been removed on-site.

Starting Phase and Maintenance

A septic tank may be used immediately. It does not require special arrangements before usage. However, digestion of sludge starts after some days only. Regular desludging after one to three years is required. When removing the sludge, some immature (still active) sludge should be left inside to enable continuous decomposition of newly settling solids. This means, if the sludge is removed by pumping, the pump head should be brought down to the very bottom. It is not necessary to remove all the liquid. The sludge should be immediately treated further in drying beds or compost pits for pathogen control. The surrounding of the septic tank should be kept free of plants in order to prevent roots from growing into the pipe lines and control chambers.

Calculation of Dimensions

Approximately 80 to 100 l should be provided per domestic user. For exact calculation, or other than domestic wastewater the formula applied in the computer spreadsheet (**Tab.23.**) may be used.

9.3 Imhoff Tank

Imhoff or Emscher tanks are typically used for domestic or mixed wastewater flows above 3 m³/d, where the effluent will be exposed above ground for further treatment, and therefore the effluent should not stink, as it could be the case with a septic tank. The Imhoff tank separates the fresh influent firmly from the bottom sludge.

The tank consists of a settling compartment above the digestion chamber. Funnel-like baffle walls prevent up-flowing foul sludge particles from getting mixed with the effluent and from causing turbulence. The effluent remains fresh and odourless because the suspended and dissolved solids do not have an opportunity to get in contact with the active sludge to become sour and foul. Retention times of much longer than 2 h during peak hours in the flow portion of the tank would jeopardise this effect.

Water pressure increases with depth of vessel.

When sludge ferments at the bottom, the sludge particles get attached to foul gas bubbles and start to float upwards, as in

the septic tank. The up-flowing sludge particles assemble outside the conical walls and form an accumulating scum layer. This scum grows continuously downwards, until the slots through which settling particles should fall into the lower compartment are closed. The treatment effect is then reduced to that of a too small septic tank. It is for this reason that the sludge and scum must be removed regularly, at the intervals the sludge storage had been designed for.

Only part of the sludge should be removed so as to always keep some active sludge present. Sludge should be removed right from the bottom to be sure that only fully digested substrate is discharged. If sludge is removed by hydraulic pressure (gravity), the pipes should be of 150 mm diameter. A hydraulic head loss of 30 cm to 40 cm must be taken into account. If pipes of only 100 mm are used, the head loss is likely to be more than 50 cm. When sludge is removed it should be immediately treated further in drying beds or compost pits for pathogen control.

The inlet and outlet pipe is made as in a septic tank. Pipe ventilation must be provided, as biogas is also produced in the

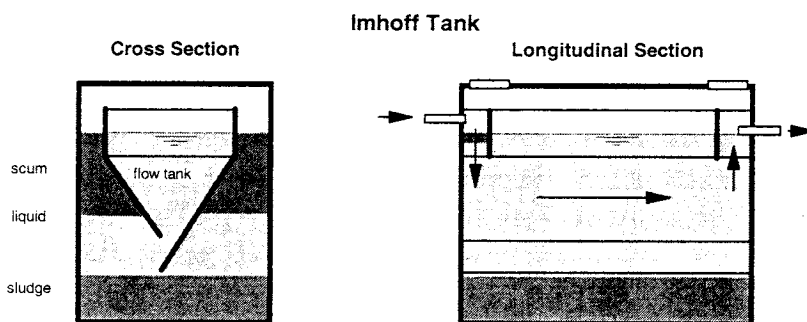

Fig. 19.

Flow principle of the Imhoff tank. The water flows quick but undisturbed from rising gas bubbles through the flow tank; the water does not mix with „ripe“ water or sludge.

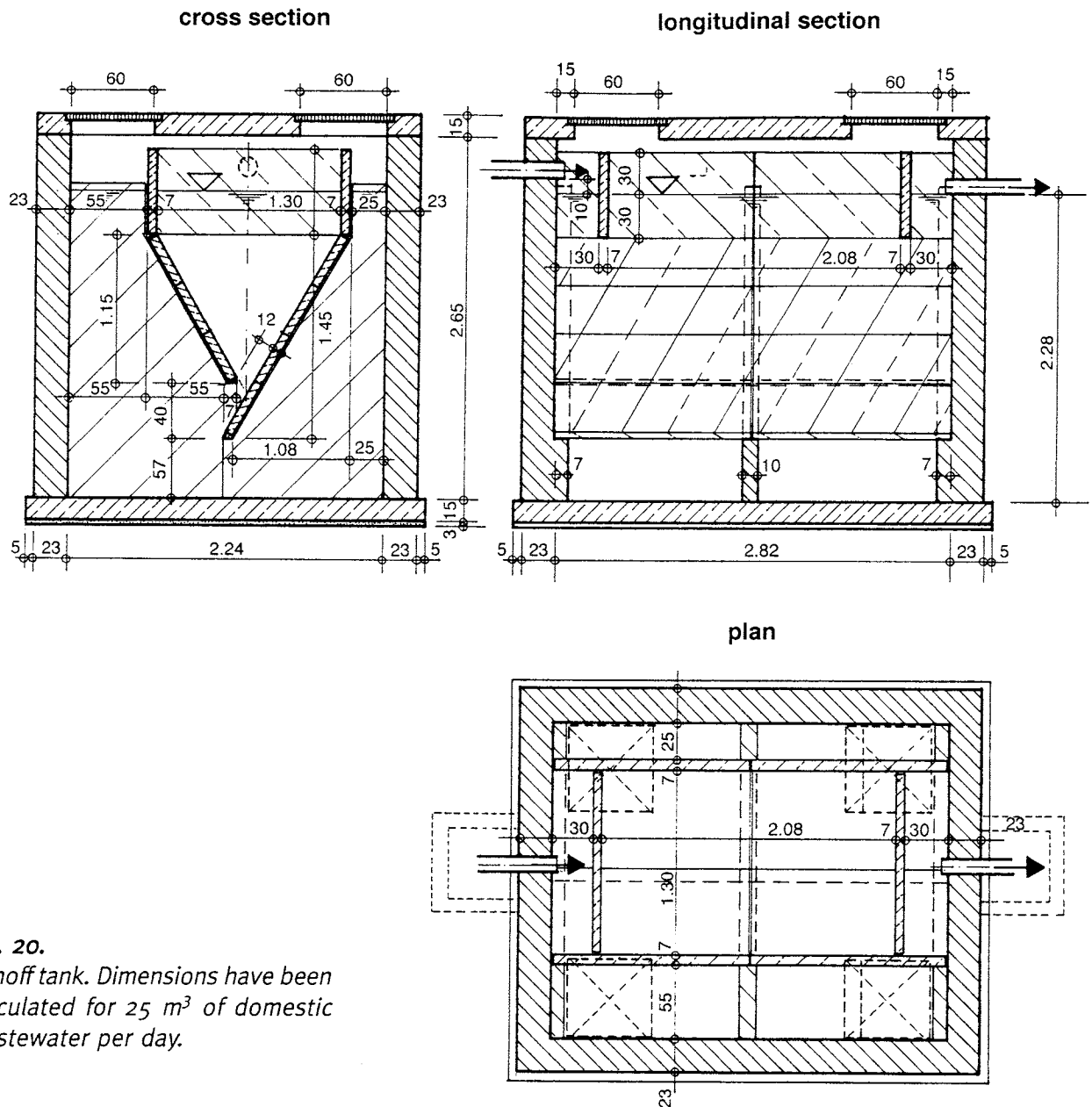

Fig. 20. Imhoff tank. Dimensions have been calculated for 25 m³ of domestic wastewater per day.

Imhoff tank. Additional baffles to reduce velocity at the inlet and to retain suspended matter at the outlet are advantageous. The upper part of the funnel-shaped baffles is vertical for 30 cm above and 30 cm below the water surface. The shape of an Imhoff tank may be cylindrical, however the funnel remains rectangular in order to leave some space outside the funnel for removal of scum. The funnel structure may consist of ready made parts from ferro-cement.

Starting Phase and Maintenance

As with the septic tank, a special starting phase is not required. Desludging is necessary at regular intervals not forgetting to leave some younger bottom sludge behind in the tank. The sludge can be removed by pumping or hydraulic pressure pipes right from the bottom. The liquid may remain inside. Scum should be removed before the sludge is removed failing which the scum must be

lifted from further down. Scum needs to be removed before it grows to the extent that it closes the slots between upper and lower compartments. Should this happen, gas bubbles appearing in rows on the water surface above the slots indicating that scum must be removed.

Calculation of Dimensions

The upper compartment, inside the funnel walls, should be designed for 2 h HRT at peak flow and the hydraulic load should be less than 1.5 m³/h per 1 m² surface area. The sludge compartment below the slots should be calculated to retain 2.5 litre sludge per kg BOD reduced per day of storage for short desludging intervals. For longer intervals use data of spread sheet (*Tab. 24.*). Treatment efficiency lies in the range of 25 to 50% COD reduction. For domestic wastewater, the upper compartment should have a volume of approximately 50 l per user and the sludge compartment below the slots, should have a volume of approximately 120 litre per user. This rule of thumb may be valid for a desludging interval of one year. For more detailed calculation or in case of non-domestic wastewater use the formula of the computer spread sheet.

9.4 Anaerobic Filter

The dominant principle of both the septic tank and Imhoff tank is sedimentation in combination with sludge digestion. The anaerobic filter, also known as fixed bed or fixed film reactor, is different in that it also includes the treatment of non-settleable and dissolved solids by bringing them in close contact with a surplus of active bacterial

mass. This surplus together with "hungry" bacteria digests the dispersed or dissolved organic matter within short retention times. Most of the bacteria are immobile. They tend to fix themselves to solid particles or, e.g. at the reactor walls. Filter material, such as gravel, rocks, cinder or specially formed plastic pieces provide additional surface area for bacteria to settle. Thus, the fresh wastewater is forced to come into contact with active bacteria intensively. The larger the surface for bacterial growth, the quicker the digestion. A good filter material provides 90 to 300 m³ surface area per m² of occupied reactor volume. A rough surface provides a larger area, at least in the starting phase. Later the bacterial „lawn“ or „film“ that grows on the filter mass quickly closes the smaller groves and holes. The total surface area of the filter seems to be less im-



Fig. 21. Floating filter balls made of plastic. When bacteria film becomes too heavy, the balls turn over and discharge their load. The filter medium has successfully been used for tofu wastewater by HRIEE in Zhejiang Province/China. [photo: Sasse]

portant for treatment than its physical ability to hold back solid particles.

When the bacterial film becomes too thick it has to be removed. This may be done by back-flash of wastewater or by removing the filter mass for cleaning outside the reactor. Nonetheless, the anaerobic filter is very reliable and robust.

By experience, on an average, 25 - 30% of the total filter mass may be inactive due to clogging. While a cinder or rock filter may not block completely, reduced treatment efficiency is indicative of clogging in some parts. Clogging happens when wastewater finds a channelled way through only some open pores as a result of which the high-speed flow washes the bacteria away. Eventually, the lesser used voids in the filter get clogged. The end result is reduced retention time within the few open voids. However, a sand or gravel filter may block completely due to smaller pore size.

tic wastewater and all industrial wastewater which have a lower content of suspended solids. Pre-treatment in settlers or septic tanks may be necessary to eliminate solids of larger size before they are allowed to enter the filter.

Anaerobic filters may be operated as down flow or up flow systems. The up flow system is normally preferred as the risk of washing out active bacteria is less in this case. On the other hand, flushing of the filter for the purpose of cleaning is easier with the down flow system. A combination of up-flow and down-flow chambers is also possible. An important design criterion is that of equal distribution of wastewater upon the filter area. The provision of adequate space of free water before the filter and the same before the outlet pipe supports equal distribution. Full-width down-flow shafts are preferred to down-flow pipes. The length of the filter chamber should not be greater than the water depth.

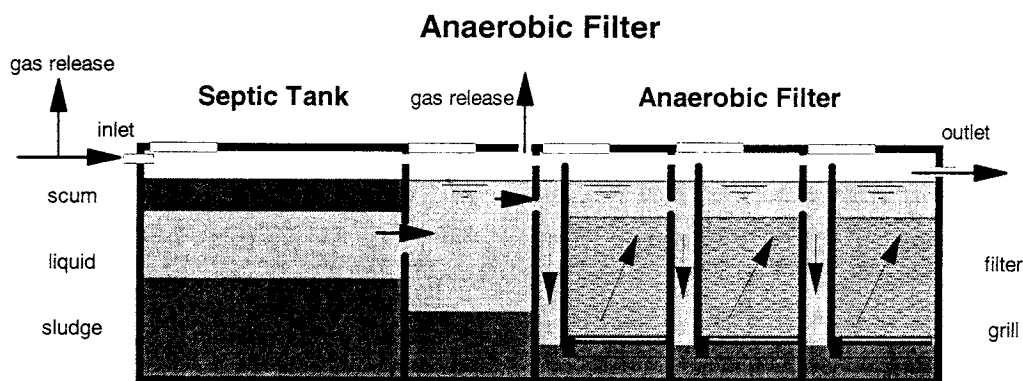

Fig. 22. Flow principle of anaerobic up-flow filter. Suspended solids are retained as much as possible in the septic tank. Anaerobic filters may also be designed for down-flow.

The quality of treatment in well-operated anaerobic filters is in the range of 70% - 90% BOD removal. It is suitable for domes-

For smaller and simple structures, the filter mass consists of cinder (5 to 15 cm in diameter) or rocks (5 to 10 cm in diameter) which are bedded on perforated concrete slabs. The filter starts with a layer of large sized rocks at the bottom. The slabs rest approximately 50 to 60 cm above ground on beams which are parallel to the direc-

tion of flow. Pipes of at least 15 cm in diameter or down-shafts over the full width allows desludging at the bottom with the help of pumps from the top. In case the sludge drying beds are placed just beside the filter, sludge may also be drawn via hydraulic pressure pipes. Head losses of 30 to 50 cm have to be counted with.

The water level of interconnected vessels is equal in all the vessels. However, there is friction loss in filters!

Starting Phase and Maintenance

Since the treatment process depends on a surplus of active bacterial mass, active sludge (e.g. from septic tanks) should be sprayed on the filter material before starting continuous operation. When possible, start with a quarter of the daily flow and only then increase the flow rate slowly over three months. As this might not be possi-

ble in practice, full treatment performance is not likely until approximately six to nine months later.

As with septic tanks, desludging should be done at regular intervals. Whenever possible, back-flush the filter before sludge removal and cleaning the filter when efficiency goes down.

Calculation of Dimensions

Organic load limits are in the range of 4 to 5 kg COD/m³×d. The hydraulic retention time compared to the tank volume should be in the range between 1.5 and 2 days. Use the formula applied in the computer spread sheet, for exact calculation (*Tab. 25*). For domestic wastewater, constructed gross digester volume (voids plus filter mass) may be estimated at 0,5 m³/capita. For smaller units it may come to 1 m³/capita.

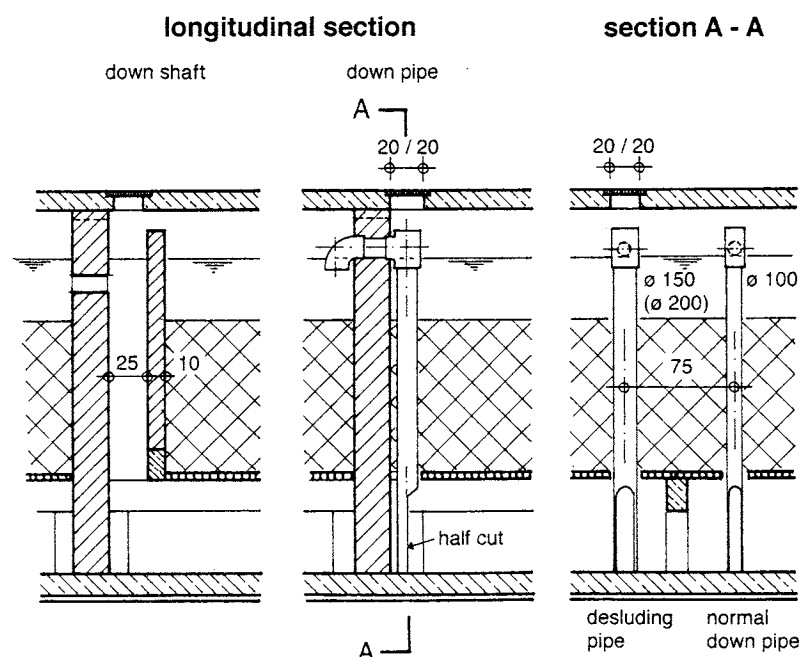

9.5 UASB

The UASB system is not considered a DEWATS technology. However, an understanding of the principle on which it functions may improve understanding of the baffled septic tank.

The UASB reactor (Upstream Anaerobic Sludge Blanket reactor) maintains a cushion of active sludge suspended at the lower

Fig. 24. Down-shaft and down-pipes. Both systems may be applied alternatively in anaerobic filters and baffled septic tanks.

part of the digester. It uses this sludge blanket directly as filter medium. Upstream velocity and settling speed of the sludge is in equilibrium and forms a locally rather stable but suspended sludge blanket. After some weeks of maturation, granular sludge forms which improves the physical stability and the filter capacity of the sludge blanket.

To keep the blanket in proper position, the hydraulic load must correspond to the upstream velocity and must correspond to the organic load. The latter is responsible for development of new sludge. This means that the flow rate must be controlled and properly geared in accordance with fluctuation of the organic load. Generally, in smaller units, fluctuation of inflow is high, but the regulation of wastewater flow is not possible. In addition, it is not possible to stabilise the process by increasing the hydraulic retention time without lowering the upstream velocity. This is most unfortunate, for otherwise a system which is relatively simple to build, is rendered unsuitable to DEWATS particularly for relatively weak, domestic wastewater.

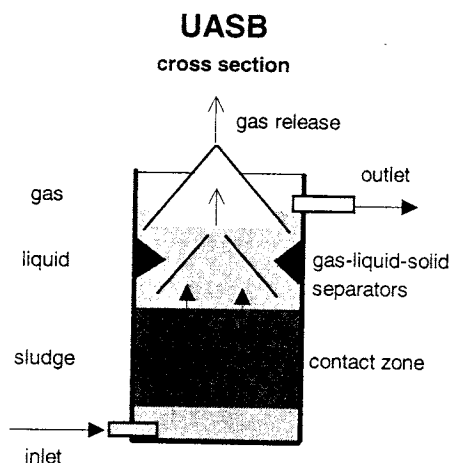

Fig. 25. Flow principle of UASB reactors. Up-streaming water and gas-driven sludge particles hit the baffles which causes separation of gas, solids and liquid.

The fully controlled UASB is used for relatively strong industrial wastewaters wherein biogas is utilised. Slanting baffles (comparative to the Imhoff tank) help to separate gas bubbles from solids, whereby solids are also separated from the up-streaming liquid. These baffles are called 3-phase separators.

UASB reactors require several months to mature - i.e., to develop sufficient granular sludge for treatment. Granular sludge is like big flocs of dust. Similarly, bacterial slime form chains which coagulate into flocs or granules. High organic loading in connection with lower hydraulic loading rates quicken the granulation process in the starting phase. To move such sludge granules to the top requires a much higher velocity than is required for single sludge particles. A granular sludge bed therefore remains more stable.

Starting Phase, Maintenance and Calculation of Dimensions

The UASB does not belong to DEWATS. Details of its operation and calculations are deliberately omitted in this handbook to avert the impression that the UASB can still be build and operated under DEWATS conditions.

9.6 Baffled Septic Tank

The baffled septic tank may be considered as the DEWATS version of the UASB system. It in fact is a combination of several anaerobic process principles - the septic tank, the fluidised bed reactor and the UASB. The baffled septic tank is also known as „baffled reactor“.

The up-flow velocity of the baffled septic tank, which should never be more than 2 m/h, limits its design. Based on a given hydraulic retention time, the up-flow velocity increases in direct relation to the reactor height. Therefore can the reactor height not serve as a variable parameter to design the reactor for the required HRT. The limited upstream velocity results in large but shallow tanks. It is for this reason that the baffled reactor is not economical for larger plants. It is also for this reason that it is not very well known and poorly researched.

However, the baffled septic tank is ideal for DEWATS because it is simple to build and simple to operate. Hydraulic and organic shock loads have little effect on treatment efficiency.

The difference with the UASB lies in the fact that it is not necessary for the sludge blanket to float; it may rest at the bottom. 3-phase separators are also not necessary since a part of the active sludge that is washed out from one chamber is trapped in the next. The tanks put in series also help to digest difficult degradable substances, predominantly in the rear part, after easily degradable matters have

been digested in the front part, already. Consequently, recycling of effluent would have a slightly negative effect on treatment quality. The baffled septic tank consists of at least four chambers in series. The last chamber could have a filter in its upper part in order to retain eventual solid particles. A settler for post-treatment could also be placed after the baffled septic tank (*Fig. 51*).

Equal distribution of inflow, and wide spread contact between new and old substrate are important process features. The fresh influent is mixed as soon as possible with the active sludge present in the reactor in order to get quickly inoculated for digestion. This is contrary to the principle of the Imhoff tank. The wastewater flows from bottom to top with the effect that sludge particles settle against the up-stream of the liquid. This provides the possibility of intensive contact between resident sludge and newly incoming liquid.

The DEWATS version does not have a grill. It always starts with a settling chamber for larger solids and impurities followed by a series of up-flow chambers. The water stream between chambers is directed by baffle walls that form a down-shaft or by down-pipes

that are placed on partition walls. Although with down-pipes the total digester can be shorter (and cheaper), down-shafts should have preference because of better distribution of flow.

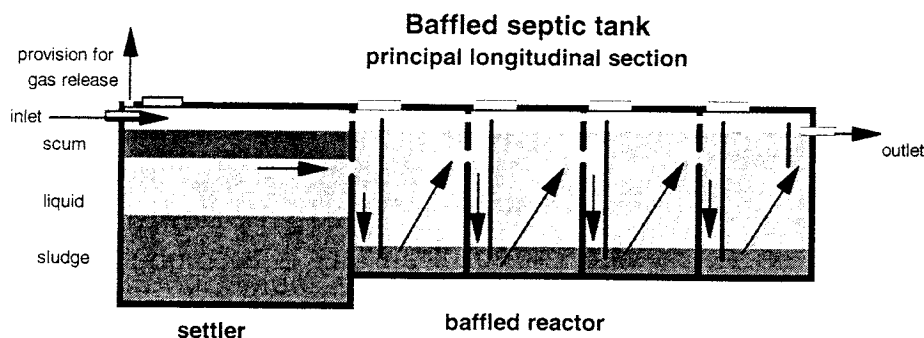
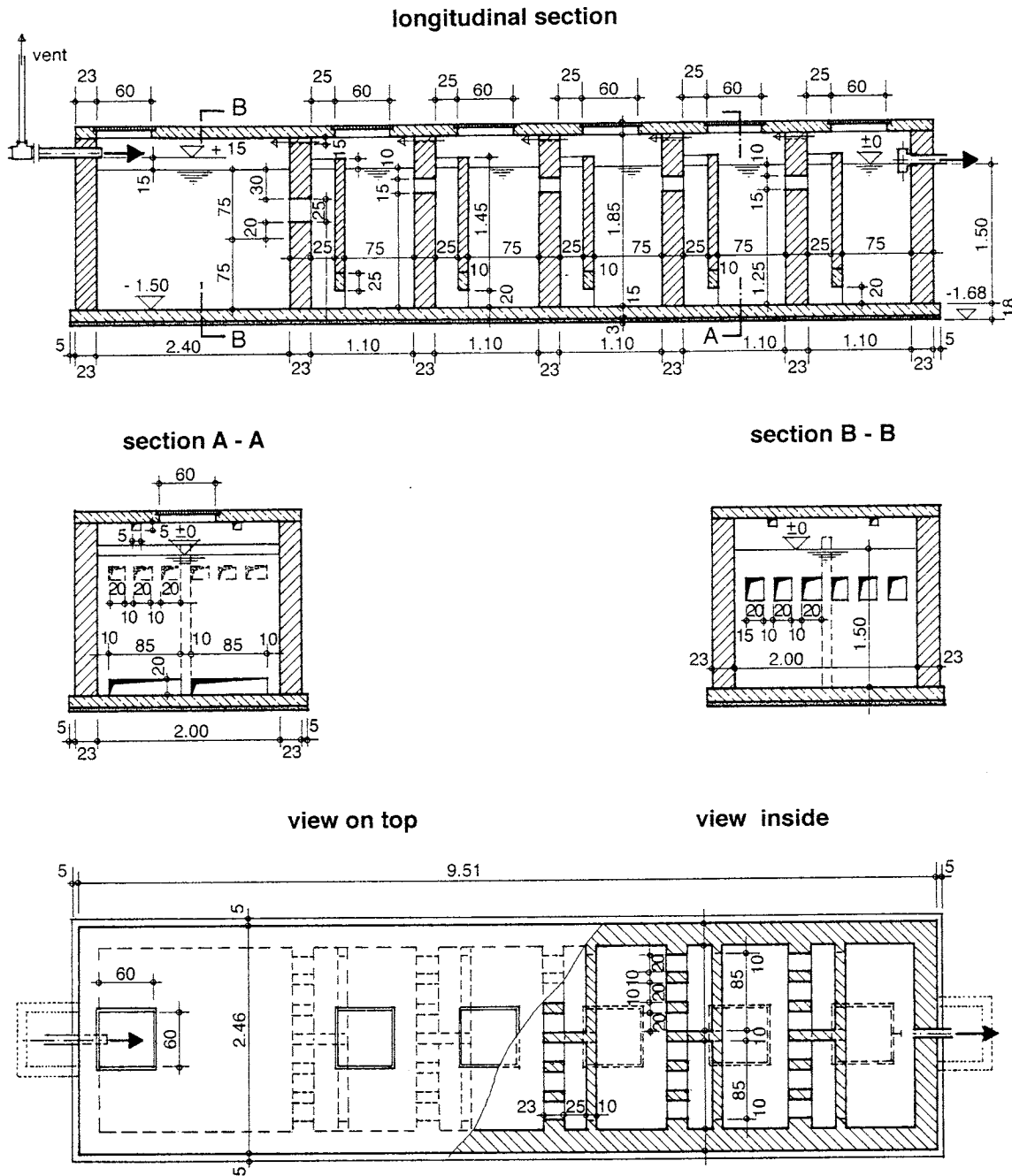

Fig. 26.

Flow principle of baffled septic tank. Incoming wastewater is forced to pass through active bacteria sludge in each compartment. The settler in front prevents larger solids to enter the baffle section.

**Fig. 27.**

Baffled Septic Tank. Dimensions have been calculated for 25 m³ domestic wastewater per day.

As already mentioned, the wastewater that enters a tank should as much as possible be distributed over the entire floor area. This is taken care of by relatively short compartments (length < 50% to 60% of the height). In case, distance between down pipes should not exceed 75 cm. For larger

plants, when longer compartments are required, the outlets of down pipes (as well as down shafts) should reach out to the centre of the floor area.

The final outlet as well as the outlets of each tank should be placed slightly below surface in order to retain any possible scum.

Baffled septic tanks may be equipped with 3-phase separators in the form of slanting baffles in the upper third of the tank, however, this is done rarely.

The baffled septic tank is suitable for all kind of wastewaters, including domestic. Its efficiency increases with higher organic load. There is relatively little experience with baffled reactors, because the system is only used in smaller units. However, it is the high efficient answer to the low efficient septic tank, because simple and efficient operation goes along with easy construction and low cost. Treatment performance is the range of 65% - 90% COD (70% - 95% BOD) removal. However, three months of maturation should be acknowledged. Sludge must be removed in regular intervals like with a septic tank. Some sludge should always be left for continuous efficiency. It is noticeable that the amount of sludge in the front portion of the digester is more, than in the rear compartments.

Starting Phase and Maintenance

Treatment performance depends on the availability of active bacterial mass. Inoculation with old sludge from septic tanks hastens the achievement of adequate treatment performance. In principle it is advantageous to start with a quarter of the daily flow and if possible with a slightly stronger wastewater. The loading rate increases slowly over three months. This would give the bacteria enough time to multiply before suspended solids are washed out. Starting with the full hydraulic load from the beginning will severely delay maturation.

Although desludging at regular intervals is necessary, it is vital that some active sludge is left in each of the compartments to maintain a stable treatment process.

Calculation of Dimensions

The up-flow velocity should not exceed 2.0 m/h. This is the most crucial parameter for dimensioning, especially with high hydraulic loading. The organic load should be below 3.0 kg COD/m³×d. Higher-loading rates are possible with higher temperature and for easily degradable substrate. The HRT of the liquid fraction (i.e. above sludge volume) should not be less than 8 hours. Sludge storage volume should be provided for 4 l/m³ BOD_{inflow} in the settler and 1.4 l/m³ BOD_{removed} in the upstream tanks. For exact calculation use the formula applied in the computer-spread sheet **Tab. 26**.

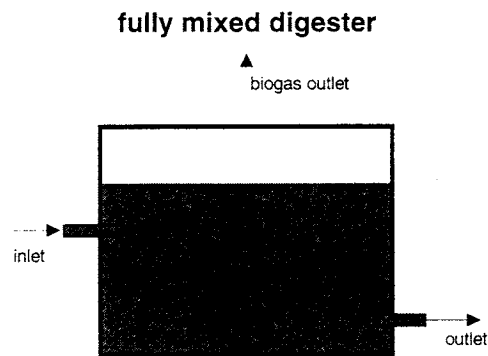

Fig. 28. Flow principle of the fully mixed anaerobic digester. There is only little sedimentation due to viscous substrate. All fractions of the substrate stay for the same period of time inside the digester. The position of inlet and outlet is less important with homogeneous liquid of high TS content. Small baffles may be provided to avoid short circuit of substrate.

9.7 Fully Mixed Digester

The fully mixed anaerobic digester corresponds to the biogas plant that is used in agricultural households of Developing Countries. It is suitable for rather "thick" and homogenous substrate like sludge from aerobic treatment tanks or liquid animal excreta. For economical reasons, it is not suitable for weak liquid wastewater, because the total volume of wastewater must be agitated and kept for full retention time (15 - 30 days) inside the digester. This leads to large digester volumes and thus, to high construction costs.

"Thick" viscous substrates of more than 6% total solid content do not need to be stirred. A digester for such a substrate may then be operated for many years without desludging because only grit, but hardly any sludge settles. Moreover, all the incoming substrate leaves the reactor after digestion. Scum formation is still possible with certain substrates. Therefore, if pipes are used for inlet and outlet they should be placed at middle height. In fixed dome digesters, the outlet is preferably made of a vertical shaft of which the opening starts immediately below the zero-line. This is in order to always allow portions of scum to discharge.

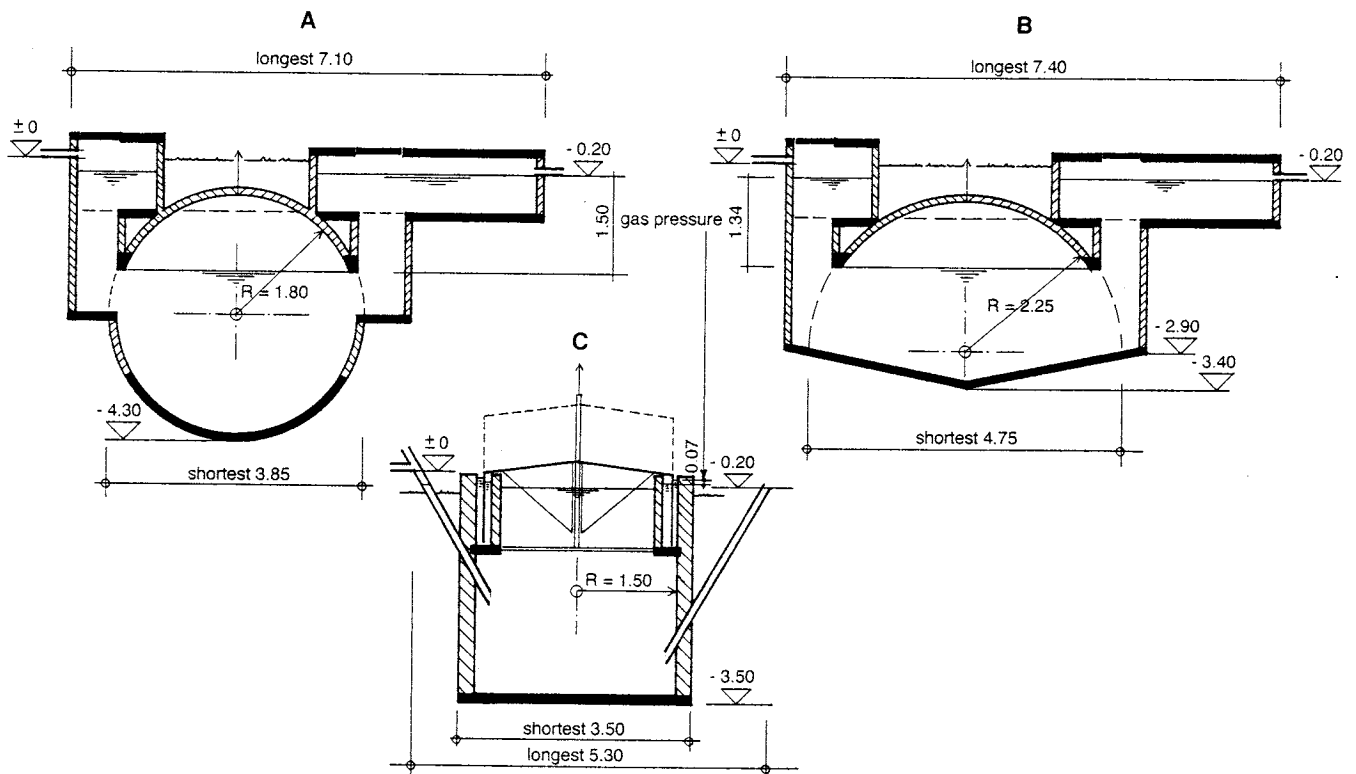

Fig. 29.

Traditional biogas plants as fully mixed anaerobic digester. A: The ball-shaped fixed dome plant with integrated gas storage and expansion chamber. B: The half-ball-shaped fixed dome plant. C: The floating drum plant with water seal. All three plants are designed for 600 litre substrate per day of 4% organic dry matter content, at 25°C and HRT of 25 days. The expected gas production is 8,42 m³/d. Comparing space requirement and gas pressure of all three plants indicate that floating drum plants are preferable in case of high gas production rates.

Because the fully mixed digester is used for strong substrate only, biogas production is high and utilisation of biogas may be recommended. In this case, the gas collector tank and the gas storage tank must be gas-tight. The immediate gas outlet should be 30 cm above substrate level. Smaller units may use the fixed dome (hydraulic pressure) system made out of masonry structure. Larger units, store the biogas in steel drums or plastic bags (see also chapter 12.).

The choice of gas storage system will depend on the pattern of gas utilisation. Normally, gas production should go together with gas consumption, time-wise and volume-wise. For more details, please refer to the chapter "Biogas Utilisation" and the abundance of special biogas literature.

Starting Phase and Maintenance

Starting with some active sludge from a septic tank speeds up digestion and prevents the digester from turning sour. In the rare case that this should happen, reduce the loading rate until the pH turns neutral. It may be necessary to remove sand and grit after some years.

Calculation of Dimensions

The main parameter is the hydraulic retention time, which should not be less than 15 days in hot climate and not less than 25 days in a moderately warm climate; a HRT of more than 60 days should be chosen for highly pathogenic substrate. The gas storage volume depends on daily gas use in relation to daily gas production. The storage capacity of gas for household use should exceed 65% of the daily gas pro-

duction. Gas production is directly related to the organic fraction of the substrate. In practice it is calculated as a fraction of the daily substrate that is fed. The fraction used for calculation is found by experience, for example, 1 kg fresh cattle dung diluted with 1 litre of water produces 40 l of biogas. For more elaborate calculation use the formula applied in the computer spread sheet *Tab. 27*.

9.8 Trickling Filter

The trickling filter is not considered to be a DEWATS solution. However, an understanding of how it works will better one's understanding of the principle of aerobic wastewater treatment.

The trickling filter follows the same principle as the anaerobic filter, in the sense that it provides a large surface for bacteria to settle. The main difference between the two systems lies in the fact that the trickling filter works under aerobic conditions. This implies that the bacteria that are immobilised at the filter medium must have equal access to air and wastewater. Therefore, certain doses of wastewater are charged in intervals to give time for air to enter the reactor during the breaks. Further, water must be distributed equally over the full surface in order to utilise the full filter mass efficiently.

Therefore, the trickling filter consists of

- a dosing device
- a rotating sprinkler
- the filter body which is ventilated both from the top and the bottom.

Rocks between 3 to 8 cm in diameter are used as filter medium. The outside of the filter body is closed to prevent sludge flies

from escaping into the open. The filter rests above ground to allow ventilation. The bottom slab is at a slope to let water and sludge be rinsed off. The bacterial film has to be flushed away regularly to prevent clogging and to remove the dead sludge. High hydraulic loading rates ($> 0.8 \text{ m}^3/\text{m}^3 \times \text{h}$) have a self-flushing effect. With organic loading rates of $1 \text{ kg BOD}/\text{m}^3 \times \text{d}$, 80% BOD removal is possible. Higher loading rates would reduce effectivity.

principle of trickling filter

wastewater is supplied in doses which allows resting time of several minutes or hours between each dose

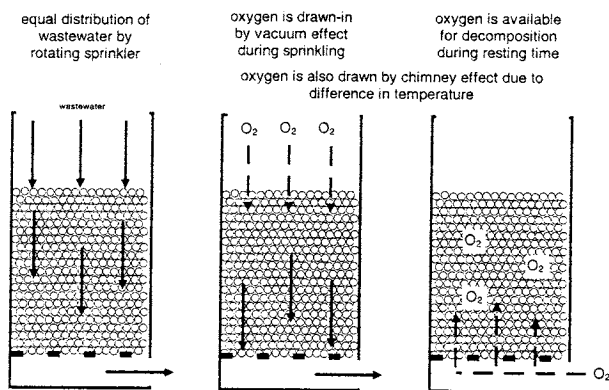

Fig. 30.

The principle of the trickling filter

Considering a 2 m high trickling filter and a wastewater of 500 mg/l BOD, the organic loading rate comes to $0.8 \times 24 \text{ hrs} \times 0.500 \text{ kg}/\text{m}^3 \text{ BOD} / 2 \text{ m height} = 4.8 \text{ kg BOD}/\text{m}^3 \times \text{d}$. A removal rate of only 60% BOD may be expected with such a high organic load. This simple calculation indicates that wastewater would have to be re-cycled almost 5 times to get the expected treatment quality and the self-flushing effect. However, the trickling filter could be operated with lower hydraulic loading rates if regular flushing is done.

Despite fluctuation in the flow of wastewater, the self-flushing (high-rate) trickling

filter is a reliable system. Nonetheless, because it requires a rotating sprinkler and a pump to be operated, it is not considered a DEWATS solution.

Starting Phase, Maintenance and Calculation of Dimensions

Details for calculation and instructions for operation are not given in this handbook in order to avoid the impression that the trickling filter can be built and operated under DEWATS conditions.

9.9 Constructed Wetlands

There are three basic treatment systems which may fall in the category of constructed wetlands. These are

- the overland treatment system
- the vertical flow filter, and
- the horizontal flow filter.

For overland treatment the water is distributed on carefully contoured land by sprinklers. The system requires permanent attendance and maintenance. For that reason it does not belong to DEWATS.

For vertical filter treatment the wastewater is distributed with the help of a dosing device on two or three filter beds which are charged alternately. Charging intervals must be strictly followed which makes the vertical filter less suitable for DEWATS.

The horizontal filter is simple by principle and requires almost no maintenance, however under the condition that it has been well designed and constructed. Design and construction requires a solid understanding of the treatment process and good

principle of vertical filter process

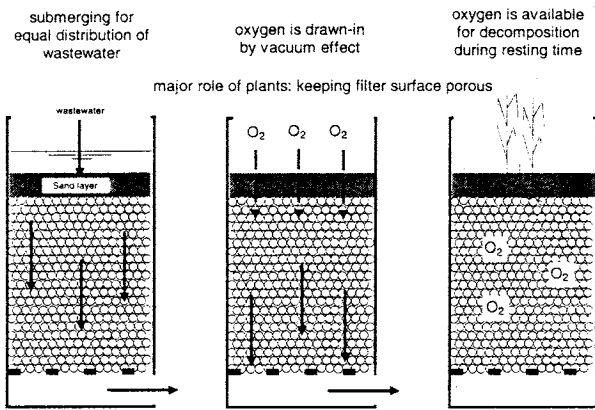

Fig. 32.
The principle of the vertical filter

knowledge of the filter medium that is to be used.

Constructed wetlands, especially sand and gravel filters, are by no means a simple

technology, although they may look like part of nature. Before deciding on filter treatment, one should always consider the alternative of constructing wastewater ponds instead. Nonetheless, filter treatment has the great advantage of keeping the wastewater below ground.

The horizontal and the vertical filter are two systems that are principally different. The horizontal filter (**Fig. 31.**) is permanently soaked with water and operates partly aerobic (free oxygen present), partly anoxic (no free oxygen but nitrate $\text{-NO}_3\text{-}$ present) and partly anaerobic (no free oxygen and no nitrate present). The vertical filter (**Fig. 32.**) is charged in intervals (similar to a trickling filter) and functions predominantly aerobically. Although the vertical filter requires only about half the area of a horizontal filter and has better treatment qualities, only the

Principle of horizontal filter process

continuous oxygen supply to the upper layers only
major role of plants: provide favourable environment for bacteria diversity

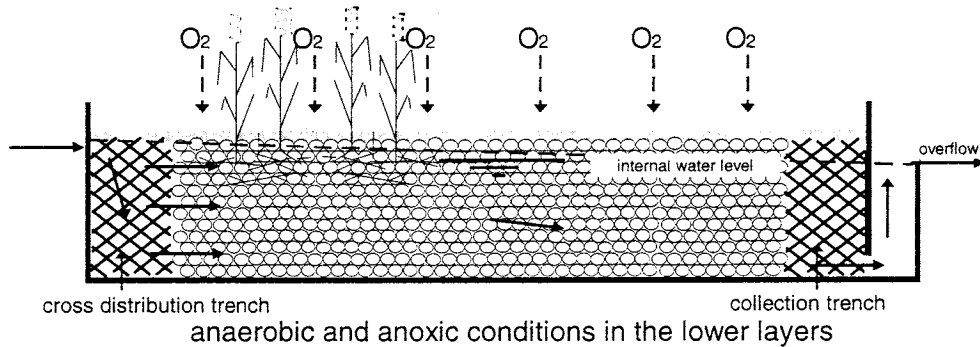

water flow in the horizontal filter

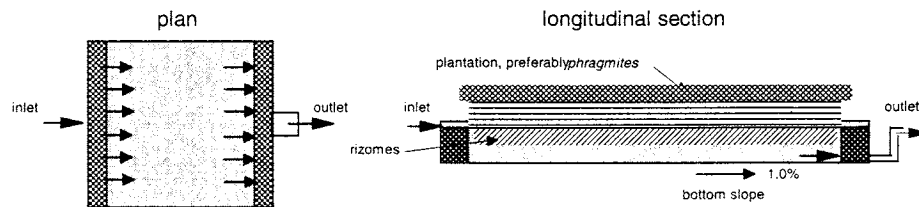

Fig. 31. The principle of the horizontal filter

horizontal filter is considered a DEWATS-technology for the reason that it has no movable parts and does not require permanent operational control.

9.10 The Horizontal Gravel Filter

Planted horizontal gravel filters are also referred to as Subsurface Flow Wetlands (SSF), Constructed Wetlands or Root Zone Treatment Plants. They are suitable for pre-treated (pre-settled) domestic or industrial wastewater of a COD content not higher than 500 mg/l. Wastewater must be pre-treated especially in respect to suspended solids, due to the fact that the biggest problem in ground filters is clogging. When testing wastewater, the sediment after 60 minutes in an Imhoff cone should not be more than 1 ml/l, and not more than 100mg SS/l in case of non-settling industrial wastewater. If the COD-value of settleable solids is less than 40% the total SS-value, then many of the solids are likely to be fat in colloidal form which can reduce the hydraulic conductivity of the filter considerably (as may be the case with dairy wastewater).

The treatment process in horizontal ground filters is complex. There are several argu-

ments "in the air" concerning the physical process of filtration, the intake of oxygen as well as the influence of plantation on the biological treatment process. Even if all influencing factors would be known, it is still their interaction which is difficult to predict.

There are sophisticated methods to calculate the proper dimensions and treatment characteristics of different filter media, especially in respect to hydraulic properties. However, such calculations make sense only if the required parameters are known quite exactly. This is almost never the case. Rules of thumb, intelligently chosen, are more than sufficient for smaller sized plants in particular, as is usually the case with DEWATS. Going beyond these figures based on experience is not advisable without previous tests. Safety rules of design are:

- large and shallow filter bed
- wide inlet zone
- reliable distribution of inflow over the full width of the inlet zone
- round coarse gravel of nearly equal size as filter medium.

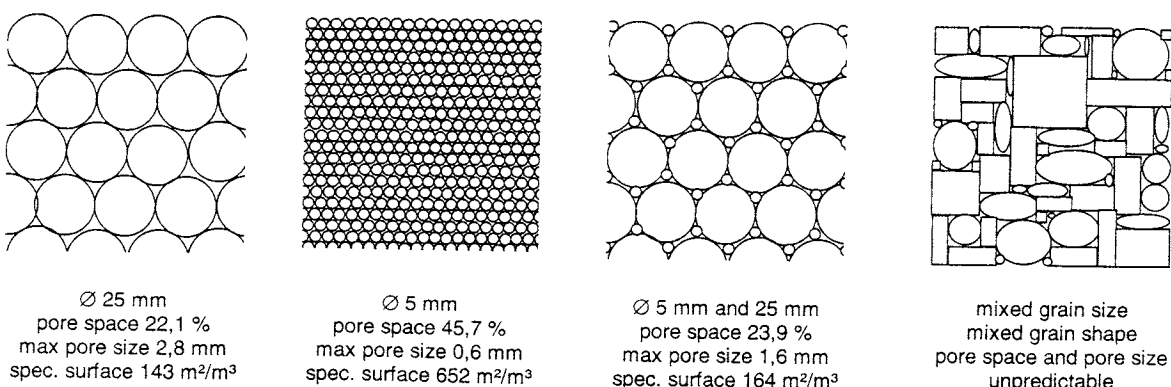

Fig. 33. Influence of grain size and shape on filter properties

While large grain size with a high percentage of voids prevents clogging, it also reduces treatment performance. Clogging is caused by suspended solids and by newly formed biological or mineralised sludge from the decomposition of organic matter. Therefore, the front portion must have voids that are small enough to retain enough SS and large enough to distribute the filtered SS over a longer distance. Round, uniform gravel of 6 - 12 mm or 8 - 16 mm is best.

Conductivity may be only half with edged broken stones compared to round gravel because of turbulent flow within irregular pores. In case of mixed grain size, it might be advisable to screen the gravel with the help of a coarse sieve; use the larger grains in the front and the smaller grains to the rear. Large grains should be chosen in case of flat or mixed grain shape, for example when using chipping made from broken stones. Care is to be taken when changing from a larger grain size to the smaller, because it has been observed that blockage happens predominantly at the point of change.

A rather flat slope ($\alpha < 45^\circ$) should join one-grain size to the other in order to obtain a larger connecting area. Particularly when grain diameter differs considerably, an intermediate zone consisting of inter-

mediate size may be considered. Mixed grain sizes will not improve hydraulic conductivity! However, removing fine soil from gravel by washing is more important than ensuring the exact grain size.

In case the length of the filter bed is more than 10 m, an intermediate channel for redistribution of cross-flow could be provided. The distribution channel could serve as a step of terrace of the surface level in case of high percentage bottom slope (*Fig. 34.*).

The relation between organic load and oxygen supply reduces with length. This happens because oxygen is supplied evenly over the total surface area, whereas the organic load diminishes during treatment. It is therefore most likely that anaerobic conditions prevail in the front part, while aerobic conditions reach to a greater depth in the rear part. However, only the upper 5 to 15 cm can really be considered an aerobic zone.

Clogged gravel filter can become useful again after resting periods of several months. This happens due to the bacteria having to go without feed and having to live on its own bacterial mass in that period. This process is called autolysis.

Filter clogging results normally in surface flow of wastewater. This is usually not

Tab. 13.

Theoretical properties of gravel and sand as filter material, lower values should be applied for wastewater when designing filter beds.

Properties of gravel and sand for ground filters					
filter medium	diameter of grain mm	pore volume		theoretical conductivity	
		coarse	total	m/s	m/d
gravel	4 - 40	30%	35% - 40%	4,14E-03	350
sand	0,1 - 4	15%	42%	4,14E-04	35

after Bahlo, Wach pg 57

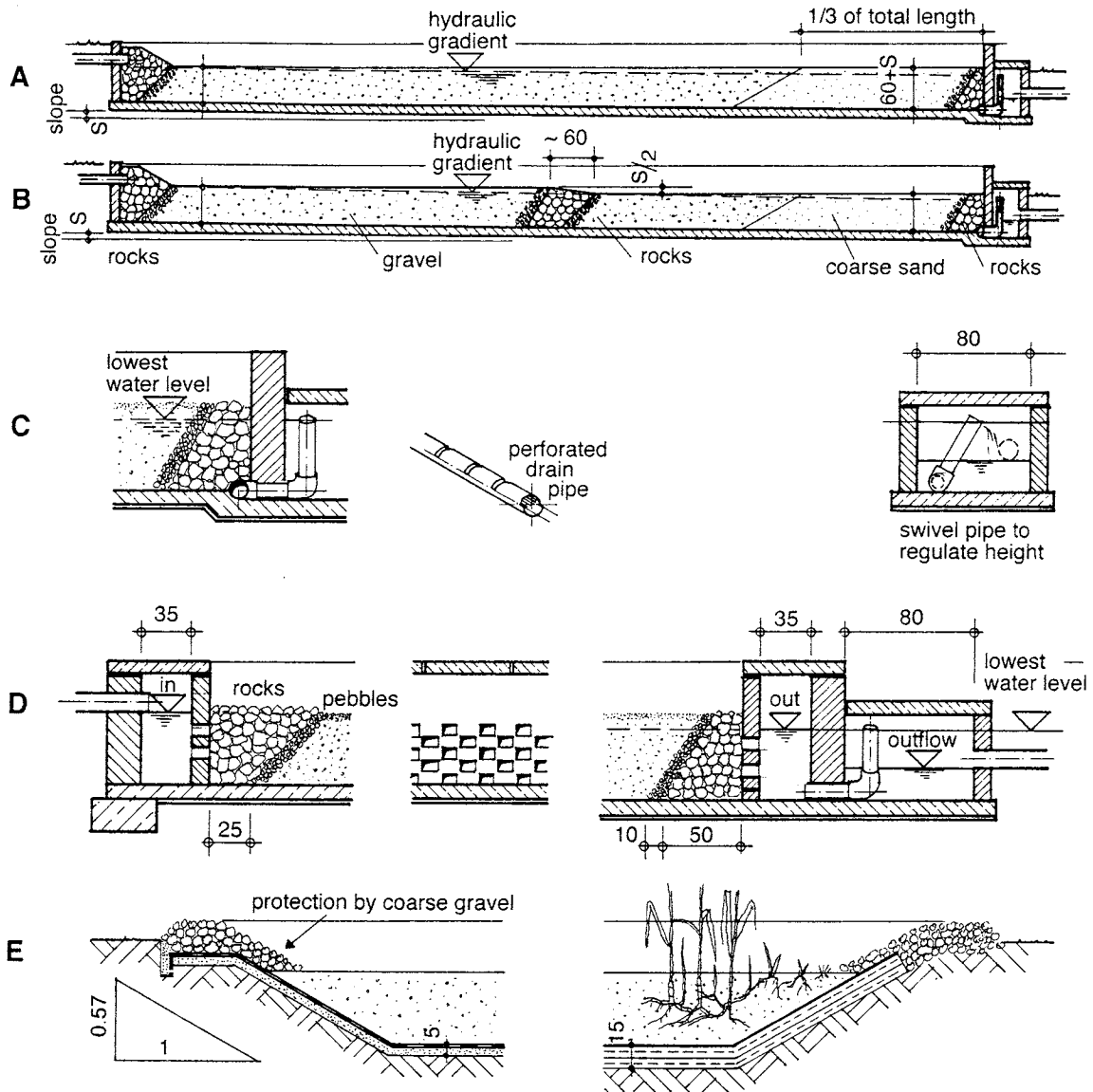

Fig. 34.

Horizontal gravel filter (subsurface flow filter). A: Filterbasin in masonry and concrete structure, finer gravel is used in the rear portion. B: Long filter bed with additional distribution trench in the middle, the trench is filled with rocks and allows a step in the surface level. C: Detail of collection pipe and swivel arm at the outlet side. D: Details of inlet and outlet structure for improved distribution of flow in case of wider filter beds. E: Details of filter basins using foils or clay packing for sealing. Sloped side walls are less costly, but plants will not grow near the rim.

wanted, although it hardly reduces the treatment efficiency if flow time on the surface is not much shorter than the assumed retention time inside the filter (this could be the case with dense plant coverage). When filters are well protected and far away from

residences there is no harm to let some of the wastewater run above the horizontal surface. Such "overland treatment" produces very good results especially when the water is equally distributed and does not fester in trenches.

The actual retention time regarding voids space plays a decisive role in the treatment process. Gravel has 30 - 45% voids, depending on size and shape. (The calculation of HRT in the spread sheet of chapter 13.1.11 is based on 35% void space, it could proportionally be reduced if the actual void space is definitely more.) Void space can easily be found out by measuring the water that can be added to a bucket full of gravel (*Fig. 35*).

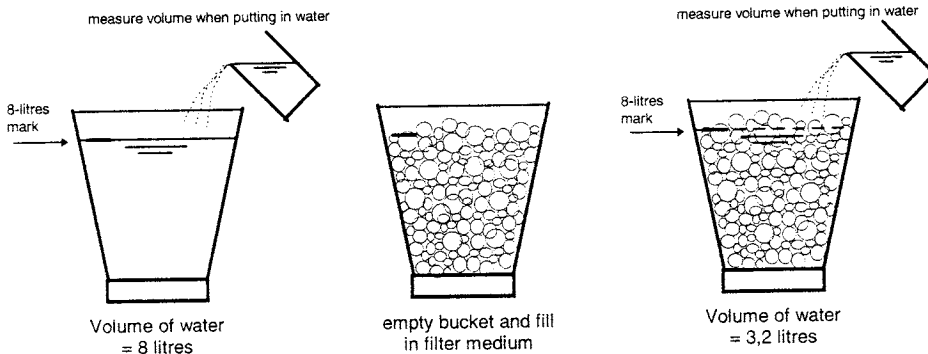

Fig. 35. Determining pore space of filter medium at site. For example the empty bucket is full after pouring 8 litre of water. The bucket filled with gravel absorbs 3.2 litre of water: Voids space is $3.2/8 = 0.40$ or 40%.

For high conductivity large pore size is more important than total pore volume. Therefore it is better to use pre-wetted gravel when testing the pore volume; then pores of only capillary size are „closed“ in advance.

In reality, short cuts and reduced volume by partly clogged areas result in 25% shorter retention times and consequently lead to inferior performance (*A.N. Shilton and J.N. Prasad in WST, Vol. 34, No. 3-4 Pg. 421*). For this reason, the filter bed should not be deeper than the depth to which plant roots can grow (30 - 60 cm) as water will

tend to flow faster below the dense cushion of roots. However, treatment performance is generally best in the upper 15 cm due to oxygen diffusion from the surface. Therefore, shallow filters are more effective compared to deeper beds of the same volume.

Uniform distribution of wastewater throughout the filter is decisively dependent on equally distributed supply of water at the inlet and equally distributed reception at

the outlet side. Trenches filled with rocks of 50 to 100 mm diameter are provided at both ends to serve this purpose. A perforated pipe that is connected to the outlet pipe lies below the strip of rocks that form the collection trench. The height of this outlet is

adjustable through a swivel arm fixed to a flexible elbow. The height is adjusted according to hydraulic conductivity by lifting it until water appears at the surface of the filter near the inlet. While the top of the filter is kept strictly horizontal to prevent erosion, the bottom slopes down from inlet to outlet by preferably 1 %. Site conditions permitting, greater slope is also possible. To prevent erosion, long filters should have a terraced surface instead of a slope (see *Fig. 34. (B)*).

Percolation of wastewater into the ground is normally not desired. To prevent this from happening the bottom of the filter must be sealed. While solid clay packing might do, heavy plastic foils are more common. A concrete basin with straight vertical masonry walls would allow plants to grow up to the outer rim, which is not possible with the smooth embankment that plastic foils would

require (Fig. 34. (E)). In dry climate, trees search for water and their roots may break the walls while trying to grow into the filter. Whenever possible, trees should not be planted directly at the side of the filter for the reason that the strong roots of the trees could well spoil the structure and fallen leaves could seal the filter surface.

Observations in Europe indicate that the performance of gravel filters diminishes after some years. How long a horizontal filter might work depends on several factors: grain size and shape of gravel, the nature and amount of suspended solids in the wastewater, the temperature and the average loading rate.

If the filter is drained during resting time, alternate charging could increase treatment performance of horizontal filters. To allow such alternate feeding, it is advisable to divide the total filter area into several compartments or beds. Other reports insist on changing the filter every 8 to 15 years. This too, nevertheless, will depend on the loading rate and structural details, of which the impact is almost impossible to predict in practice. Weaker wastewater, lower loading rates and larger grain size of the gravel is assumed to increase the lifetime of the system.

Ground filters are covered by suitable plantation - meaning any plant which can grow on wastewater and whose roots go deep and spread wide. To an extent, performance may also depend on the species of plant chosen. Some scientists claim that the micro-environment inside the filter is such that it creates equilibrium between sludge production and sludge "consumption". Such equilibrium is only likely with low loading rates.

Plants are normally not harvested. *Phragmites australis* (reed) the world over is considered to be the best plant because its roots form horizontal rhizomes that guarantee a perfect root zone filter bed. (Fig. 36.). There could be other plants to suit other wastewater. For instance, *typha angustifolia* (cattails) together with *scirpus lacustris* (bull rush) has been found most suitable for wastewater from petrol refineries. Most swamp and water grasses are suitable, but not all of them have extending or deep roots. The large, red or orange flowering iris (sometimes known as "mosquito lily") grows well on wastewater. It is a beautiful plant, however suitable for shallow domestic gravel beds, only. Forest trees have also been used and are said to be only slightly less efficient (*Kadlec and Knight*). Whatever, at least 2 bunches of plants or four sprouted rhizomes should be placed per square meter when starting plantation.

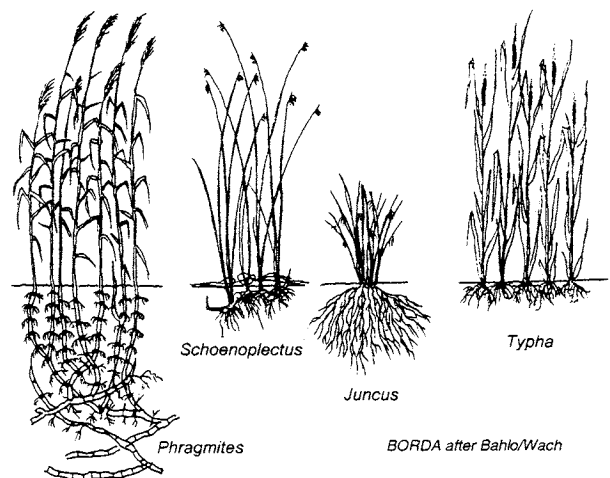

Fig. 36.
Plant species common for gravel filter plantation

Several experts propose a certain follow up of plant species to improve treatment quality. However, the main role of the plants seems to be that of a „catalyst“ rather than

an „actor“. Plants transport oxygen via their roots into the ground. Some scientists claim that surplus oxygen is also provided for creating an aerobic environment while others have found out that only as much oxygen as the plant needs to transform its own nutrient requirement, is transferred. For example *Brix and Schierup* claim that $0,02 \text{ g O}_2/\text{m}^2 \times \text{d}$ are provided by the plants to the filter bed, while $2,06 \text{ g}/\text{m}^2 \times \text{d}$ are used by the plants themselves. Toxic substances near the roots may also be eliminated by oxidation. Howsoever, the complex ecosystem that exists in a gravel filter together with plantation in all respects produces good and reliable treatment results, which must definitely be aerobic, as well. Some reports claim COD reduction rates of over 95% which would not be possible under anaerobic conditions alone. The uptake of nutrients by plants is of relatively little importance, especially when plants are not harvested.

Starting Phase and Maintenance

Young plant seedlings may not grow on wastewater. It is therefore advisable to start feeding the plant with plenty of fresh water and to let the pollution load grow slowly and parallel to plant growth.

When plants are under full load, the outlet level is adjusted according to the flow. Water should not stand on the surface near the inlet. If this should happen, the swivel arm at the outlet must be lowered. Optimal water distribution at the inlet side is important and must be controlled from time to time. It is necessary to replace the filter media when treatment efficiency goes down. Since there is no treatment during the time that the filter media is being replaced, it is advantageous to install several parallel filter beds.

Stormwater should neither be mixed with the wastewater before, nor should outside stormwater overflow the filter bed, because of the fine soil particles which come with that water. Erosion trenches around the filter bed should always be kept in proper functioning condition.

Calculation of Dimensions

If percolation properties - the so called hydraulic conductivity of the filter body - is known, then the required cross sectional area at the inlet can be calculated using Darcy's law. To make good for reduced conductivity after some time of operation only a fraction of the calculated figures for clear

<p>Darcy's Law</p> <p>cross sectional area of filter bed [m²] =</p>	$A_c = \frac{Q_s}{k_f \times dH / ds}$
<p>=</p>	$\frac{\text{flow rate [m}^3/\text{sec}]}{\text{hydraulic conductivity [m/sec]} \times \text{slope [m height/m length]}}$

Fig. 37.
Darcy's law for calculation of hydraulic conductivity

water should be used for designing the plant. The conductivity given in the spread sheet takes care of that, already. However, not to the extent of some pessimistic statements which claim that only 4% of the clear water conductivity should be used.

The dimensions of the filter depend on hydraulic and organic loading and temperature and grain size of the filter medium. As a rule of thumb, 5 m² of filter should be provided per capita for domestic wastewater. This would mean a hydraulic loading rate of 30 l/m² and an organic loading rate of 8 g BOD/m²×d. For comprehensive calculation use of the formula applied in the computer spread sheet (**Fig 133**).

9.11 Vertical Sand Filter

The vertical filter functions like an aerobic trickling filter and consequently must be fed at intervals with defined resting times between the doses of charging. In addition to the short intervals that are controlled by dosing devices, longer resting periods of one or two weeks are also required. This is only possible with at least two filter beds that are fed alternately.

Feeding in doses is necessary for equal water distribution. The resting times are needed to enable oxygen to enter the filter after wastewater has percolated (**Fig. 32**). Doses must be large enough to completely flood the filter for a short while in order to distribute the water evenly over the sur-

face and small enough to allow enough time for oxygen to enter before the next flooding. Correspondingly, the filter material must be fine enough to cause flooding and porous enough to allow quick percolation.

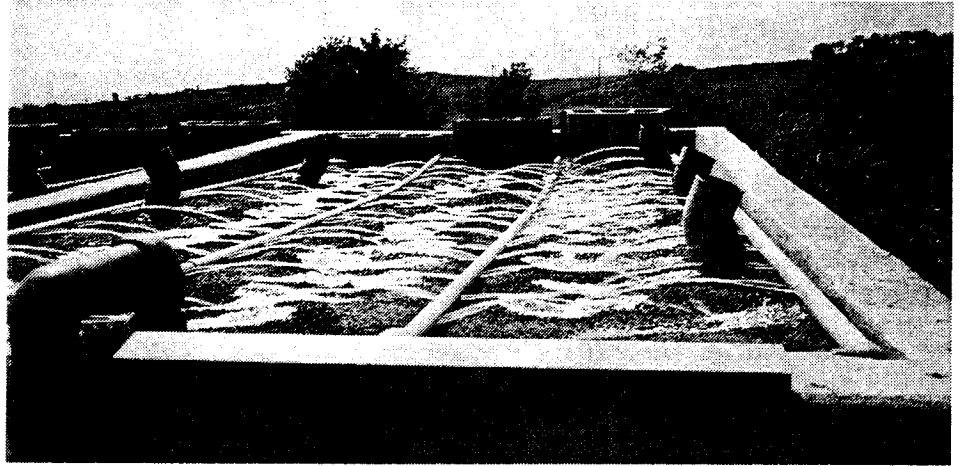

Fig. 38. Vertical filter during charging. Constructed above ground by Nature & Technique, D. Esser, for a cheese dairy in southern France. [photo: Sasse]

During the short time of charging, the wastewater is also exposed to the open, which can create 'bad odour' in case of anaerobic pre-treatment. The vertical filter is not propagated as DEWATS largely because keen observation of all the above mentioned points are essential. Aside from this disadvantage, the vertical filter is - compared to the horizontal filter - the more efficient and more reliable treatment systems from a technical and scientific point of view, reasons for which its main features are described herein.

The body of the vertical filter consist of a finer top layer, a medium middle layer and a rough bottom layer. The area below the filter media is a free flow area that is connected to the drainpipe. The free flow area is also connected to the open via additional

vent pipes. The fine top layer guarantees equal water distribution by flow. The middle layer is the actual treatment zone while the bottom layer is responsible for providing wide-open pores to reduce the capillary forces which otherwise would decrease the effective hydraulic gradient.

The most usual depth of vertical filters is 1 m to 1.20 m. However, if there is enough natural slope and good ventilation, vertical filters can also be built up to a depth of 3 metres. Vertical filters may or may not be covered by plantation. In the absence of plantation, the surface must be scratched at the beginning of the resting period, in order to allow enough oxygen to enter. With dense plantation however, this is avoidable as the stems of plants keep the pores open on the surface.

Several charging points are distributed over the surface to allow quick flooding of the full area. Flooding is the only reliable method of achieving equal distribution of water over the filter. It is not possible to achieve equal distribution by using supply pipes of different diameters or by a proper calculation of the distance of outlet points. This has been tried often enough; new failures are not necessary. Flush distribution is a must.

Dosing of flow can be done with the help of either self acting siphons, automatic controlled pumps or tipping-buckets. The latter might be the most suitable under DEWATS conditions because its principle is easily understood and the hardware can be manufactured locally.

Each filter bed has a separate inlet pipe with valve. Alternately, a straight standing piece of pipe can be used for closing the outlets of the dosing chamber (*Fig. 40.*).

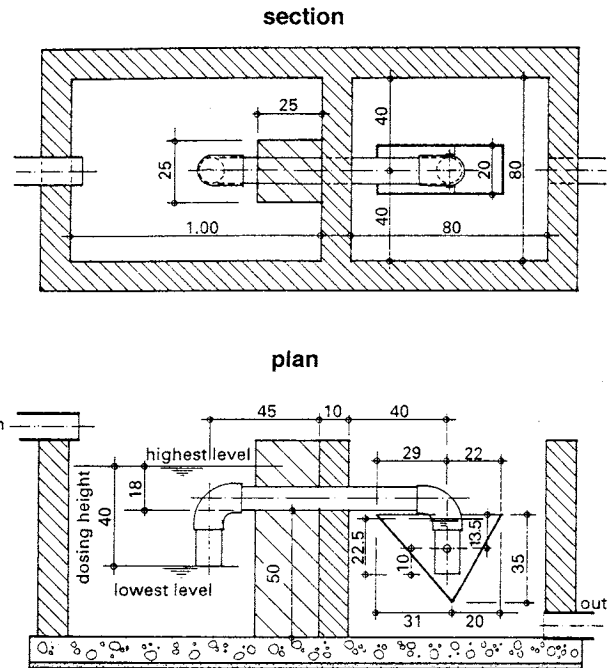

Fig. 39. Dosing chamber with tipping bucket for controlled operation of siphon. The bucket closes the siphon until it is filled with water. When losing its equilibrium due to the weight of the water, the bucket turns over and opens the siphon. It falls back into horizontal position to receive new water, which again closes the siphon for the next flush.

While vertical filters can bear a hydraulic load up to $100 \text{ l/m}^2 \times d$ ($100 \text{ mm/m}^2 = 0.1 \text{ m}$) it is better restricted to $50 \text{ l/m}^2 \times d$. The organic load can go up to $20 \text{ g BOD/m}^2 \times d$. In case of re-circulation, $40 \text{ g BOD/m}^2 \times d$ is possible (*M&E*). In the case of pre-treated domestic wastewater, the hydraulic load is the deciding factor. Some engineers use these values only for the active filter beds while others claim that the resting beds may also be included. Testing is called for in case of doubt. However, the provision of a larger filter area is always recommended.

Calculation of permeability follows also Darcy's law (*Fig. 37.*), whereas $dH/ds = 1$. Therefore flow speed ($v = Q_s/Ac$) is equal to hydraulic conductivity (k).

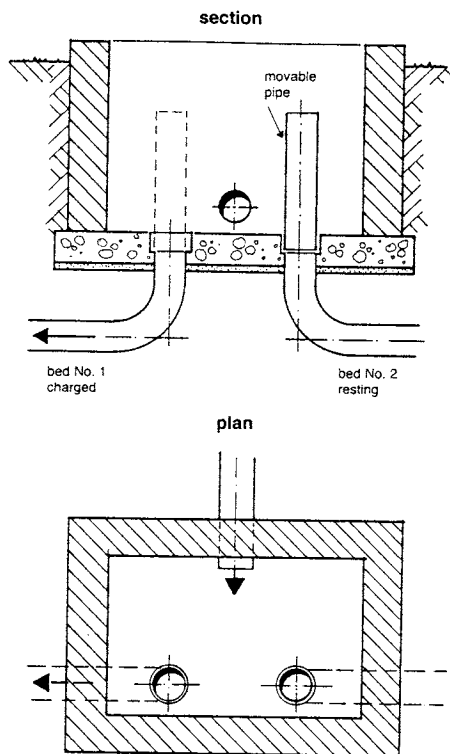

Fig. 40.
Distribution chamber for alternate feeding of filter beds. A piece of straight pipe is put on that outlet which is to be closed, temporarily.

Starting Phase, Maintenance and Calculation of Dimensions

The vertical sand filter does not belong to DEWATS. Detailed operational instructions have been deliberately excluded in this handbook to avoid the impression that the vertical filter can still be build and operated under DEWATS conditions.

9.12 Ponds

Ponds (lagoons) are artificial lakes. What happens in ponds closely represents treatment processes which take place in nature. In artificial ponds the different treatment processes are often separated. All ponds are ideal DEWATS and should be given

preference over other systems whenever land is available. Ponds are preferred before underground gravel filters if an open pond is acceptable to the surrounding. In case of facultative or anaerobic ponds, the distance to residential houses or working places should be far enough to avoid nuisance by mosquito breeding, or bad odour. Polishing ponds can be nearer because the use of fish to control mosquitoes is possible. Fish that belong to *Gambusia spp.* are commonly used for mosquito control in tropical countries.

Pure pond systems are cheap and need almost no maintenance, even in larger size.

Ponds may be classified into

- sedimentation ponds (pre-treatment ponds with anaerobic sludge stabilisation)
- anaerobic ponds (anaerobic stabilisation ponds)
- oxidation ponds (aerobic cum facultative stabilisation ponds)
- polishing ponds (post-treatment ponds, placed after stabilisation ponds)

Pond systems that are planned for full treatment normally consist of several ponds serving different purposes. For instance, a deep anaerobic sedimentation pond for sedimentation cum anaerobic stabilisation of sludge, two or three shallow aerobic and facultative oxidation ponds with longer retention times for predominantly aerobic degradation of suspended and dissolved matter and one or several shallow polishing ponds for final sedimentation of suspended stabilised solids and bacteria mass. Wastewater ponds for the purpose of fish farming must be initially low loaded, and in addition, be diluted by four to five times with river water.

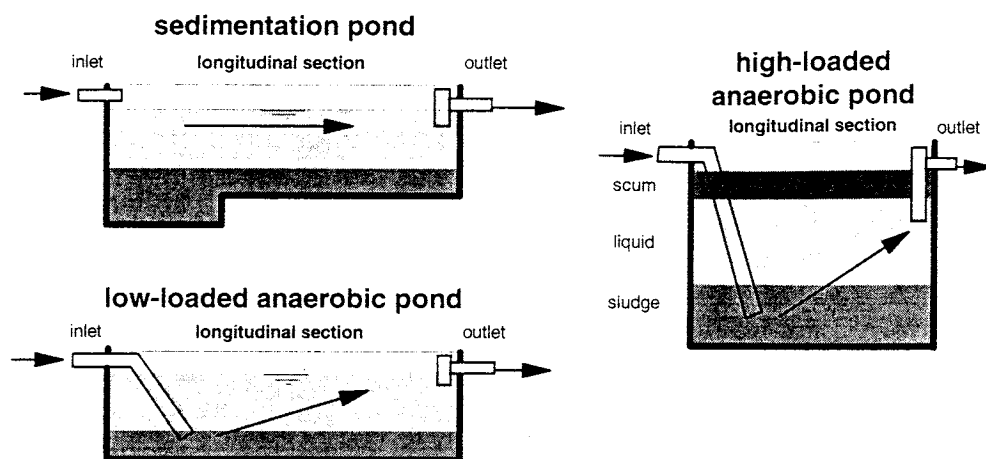

Fig. 41.

Principles of anaerobic ponds. Sedimentation ponds have a HRT of about 1 day, low loaded ponds are supposed to be odourless because of almost neutral pH, high loaded ponds form a sealing scum layer on top.

Tab. 14.

An example of the high performance of a simple settling pond

Performance of a settling pond of 48 hrs HRT for domestic sewage in Morocco

pollutant	dimension	inflow	outflow	rem rate
suspended solids	mg/l	431	139	68%
COD mg/l	mg/l	1189 *	505	58%*
BOD ₅	mg/l	374	190	49%
Nkjel	mg N/l	116	99	15%
P total	mg/l	26	24,5	6%
fecal coli	No/100 ml	6.156.000	496.000	92%
fecal strepto	No/100 ml	20.900.000	1.603.000	92%
nematode ova	No	139	32	77%
cestode ova	No	75	18	76%
helminth ova	No	214	47	78%

* the high COD/BOD ratio is caused by mineral oil pollution which is also the reason for the COD removal rate being higher than that of the BOD₅

Driouache et al, GTZ / CDER, 1997 pg 17

Tab. 15.

Design parameters for low loaded anaerobic ponds in relation to ambient temperature

Design parameters for low loaded anaerobic ponds

ambient temper. °C	org. load BOD g/m ³ *d	efficiency BOD rem. %
10	100	40
15	200	50
20	300	60
23	330	66
25	350	70
28	380	70
30	400	70
33	430	70

from Mara 1997

Otherwise the pond must be about ten times larger than calculated in the spread sheet (Tab. 30).

Artificially aerated ponds are not considered to be DEWATS and are therefore not dealt with in this handbook. It may be enough to know that such ponds are

1,5 - 3,5 m deep, usually work with a 5 days hydraulic retention time (HRT) and organic loads of 20 to 30 g BOD/m³*d. The energy requirement for aeration is about 1 - 3 W/m³ of pond volume. In case of only little scum formation only the surface of anaerobic ponds may be aerated to reduce foul smell.

9.12.1 Anaerobic ponds

Anaerobic ponds are deep (2 to 6 m) and highly loaded (0.1 to 1 kg BOD/m³×d). Because of that they need less surface area compared to aerobic-facultative oxidation ponds. Anaerobic ponds maintain their anaerobic conditions only through the depth of the pond, therefore a minimum depth of 2 m is necessary. It is possible to provide separate sludge settling tanks before the main pond, in order to reduce the organic sludge load of that pond. Such settling tanks should have a HRT of less than 1 day, depending on the kind of wastewater.

Anaerobic ponds with organic loading rates below 300 g/m³×d BOD are likely to stay at an almost neutral pH. Consequently they release little H₂S and therefore, are almost free of unpleasant smell. Highly loaded anaerobic ponds are particularly bad smelling in the beginning until a heavy layer of scum has been developed. Before such scum layer has developed, a small upper

layer will remain aerobic; one may then label these ponds facultative-anaerobic ponds.

Depending on strength and type of wastewater and the desired treatment effect, anaerobic ponds are designed for hydraulic retention time between 1 and 30 days. It depends on whether only settled sludge or all the liquid is to be treated. The kind of wastewater and the type of post treatment defines the role of the anaerobic pond. For domestic wastewater the anaerobic pond may function as an open septic tank. It should then be small in order to develop a sealing scum layer. Treatment efficiency is in that case in the range of 50% to 70% BOD removal, only.

A stinky effluent is the result of a „wrong“ retention time. Because, if the retention time is longer than one day, not only bottom sludge but also the liquid portion starts to ferment. On the other hand, if the retention time is too short for substantial stabilisation

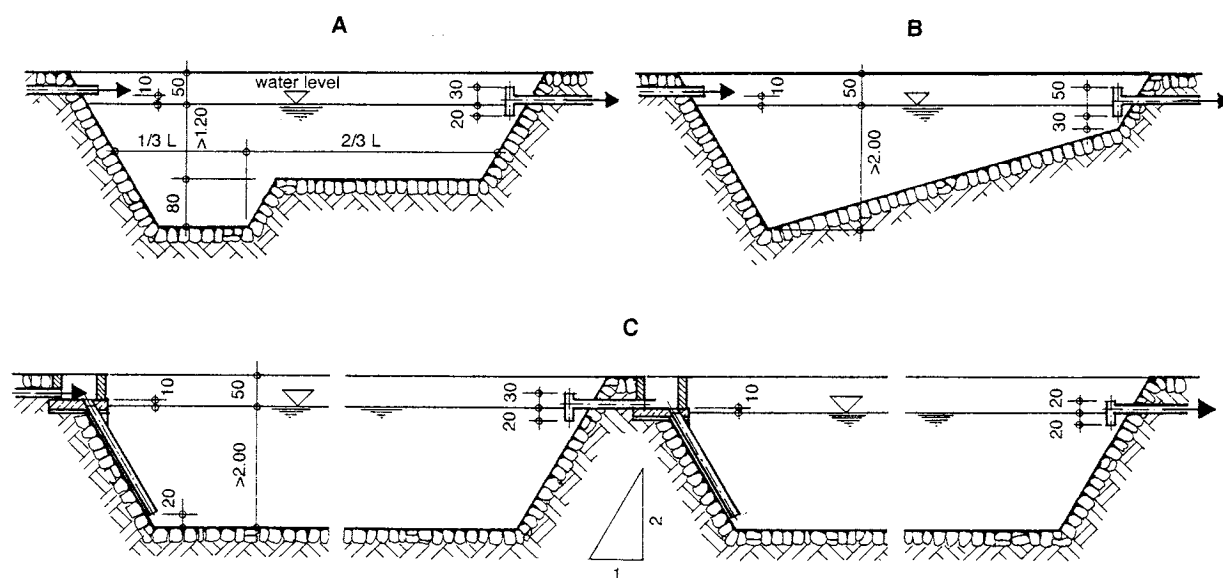

Fig. 42.

Cross sections of anaerobic ponds constructed out of rocks with cement mortar pointing. A and B: The inlet portion is made deeper in order to accumulate most of the sludge at a limited surface area. C: Two anaerobic ponds in series. The first pond may be high loaded (scum sealed), the second pond may be low loaded (neutral pH).

of the liquid, then the effluent remains at a low pH and stinks of H_2S . Normally, too short retention times mean also too high organic loading rates.

Anaerobic ponds are often used as the first treatment unit for industrial wastewater, followed by oxidation ponds, for example in sugar plants or distilleries. Treatment efficiency of high-loaded ponds with long retention times is in the range of 70% to 95% BOD removal (COD_{rem} 65% to 90%) depending on biodegradability of the wastewater. Several ponds in series are recommended in case of long retention times.

Anaerobic ponds are not very efficient to treat wastewater with a wide COD/BOD ratio ($>3 : 1$). Sedimentation ponds with very short retention times followed by aerobic / facultative stabilisation ponds give better results in that case.

Pond size is also based on the long-term sludge storage volume that in turn relates to long cleaning intervals. The anaerobic pond can also be used as integrated sludge storage. In this case, sludge removal intervals of over 10 years are possible.

Starting Phase and Maintenance

The start-up does not require special arrangements. It should however be known that a heavy loaded pond would release bad odour until a layer of scum seals the surface. Inlet and outlet structures should be controlled during operation. A drop in the quality of the effluent is a warning that the sludge must be removed. If this is neglected, the receiving waters or the treatment units which follow the pond will be put into trouble.

Calculation of Dimensions

Retention time and volumetric organic load are the two design parameters for anaerobic ponds. A non-smelling pond loaded with $300 \text{ g BOD/m}^3 \times \text{d}$, for a short HRT of one day would mean approximately $0,2 \text{ m}^3$ per capita for domestic wastewater. For anaerobic stabilisation of the liquid fraction longer retention times are required which depend on temperature, desired treatment quality and organic load. Organic loading rate should not exceed $1 \text{ kg BOD/m}^3 \times \text{d}$. For exact calculation use the formula applied in the computer spread sheet (*Tab. 29a, 29b*).

9.12.2 Aerobic Ponds

Aerobic ponds receive most of their oxygen via the water surface. For loading rates below $4 \text{ g BOD/m}^2 \times \text{d}$, surface oxygen can meet the full oxygen demand. Oxygen intake increases at lower temperatures and with surface turbulence caused by wind and rain. Oxygen intake depends further on the actual oxygen deficit up to saturation point and thus may vary at 20°C between $40 \text{ g O}_2 / \text{m}^2 \times \text{d}$ for fully anaerobic conditions and $10 \text{ g O}_2 / \text{m}^2 \times \text{d}$ in case of 75% oxygen saturation. (*Mudrak & Kunst, after Ottmann 1977*).

The secondary source of oxygen comes from algae via photosynthesis. However, in general, too intensive growth of algae and highly turbid water prevents sunlight from reaching the lower strata of the pond. Oxygen „production“ is then reduced because photosynthesis cannot take place. The result is a foul smell because anaerobic facultative conditions prevail. Algae are important and positive for the treatment process, but are a negative factor when it comes

to effluent quality. Consequently, algae growth is allowed and wanted in the beginning of treatment, but not desired when it comes to the point of discharge, because algae increase the BOD of the effluent. Algae in the effluent can be reduced by a small last pond with maximum 1 day retention time. Larger pond area - low loading rates with reduced nutrient supply for algae - are the most secure, but also the most expensive measure.

Laboratory results of effluent wastewater often give a false impression of insufficient treatment. As nearly 90% of the effluent BOD comes from algae, many countries allow higher BOD loads in the effluent from ponds as compared to other treatment systems. Baffles or rock bedding before the outlet of each of the ponds have remarkable effect on retaining of algae. Intelligent structural details increase the treatment quality considerably at hardly any additional cost and may be seen as important as adequate pond size.

Treatment efficiency increases with longer retention times. The number of ponds is of only relative influence. With the same total surface, efficiency increases by splitting one

pond into two ponds by approximately 10 %. Having three instead of two ponds adds about 4 % and from three to four ponds efficiency may be increased by another 2 %. This shows that more than three ponds are not justifiable from an economic point of view, because the same effect can be achieved by just enlarging the surface area. The land required for dams and banks of an additional pond could better directly be added to the water area. The first pond may be up to double the size of the others, if there are several inlet points.

In principle, it is of advantage to have several inlet points in order to distribute the pollution load more equally and to create a larger area for sedimentation. On the other hand, it might be advisable to provide a slightly separated inlet zone in order to avoid bulky floating matters littering the total pond surface.

The inlet points should be farthest away from the outlet. The outlet should be below water surface in order to retain floating solids, including algae. Gravel beds functioning as roughing filter are advisable between ponds in row and before the final outlet.

Aerobic Ponds in Series with Polishing Pond

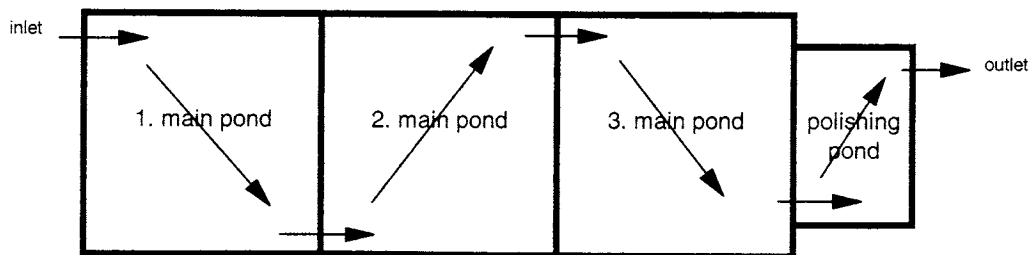

Fig. 43.

Flow pattern of aerobic-facultative ponds in series

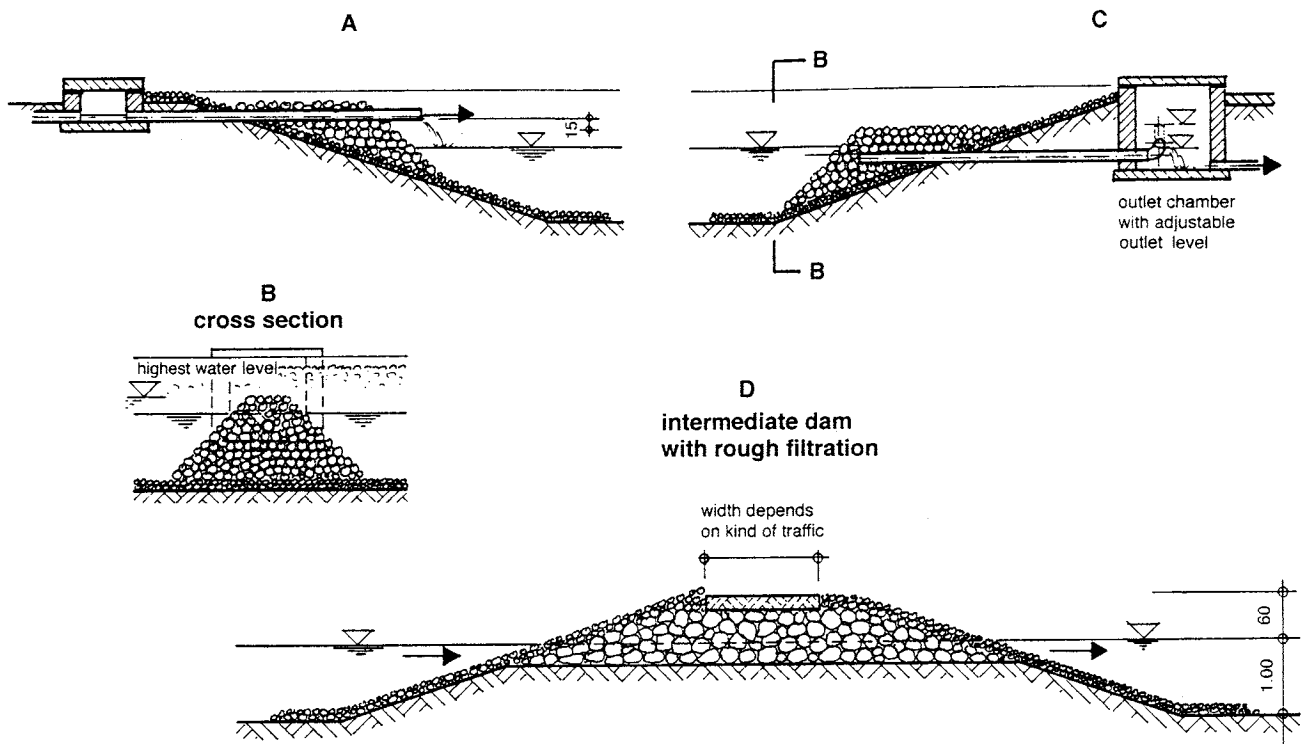

Fig. 44.

Section through a large sized aerobic-facultative stabilisation pond. Banks should be protected against erosion by waves. A: Inlet; banks should also be protected against erosion by influent. B: Cross section B-B (front view of C). C: Outlet structure with swivel arm to adjust height of pond according to seasonal fluctuation of water volume.

Erosion of banks by waves could be a problem with larger ponds. Therefore slope should be 1 (vertical) to 3 (horizontal) and preferably covered with rocks or large sized gravel.

Banks and dams could be planted with macrophytes, such as cattail or *phragmites*. Dams between ponds should be paved and wide enough to facilitate maintenance.

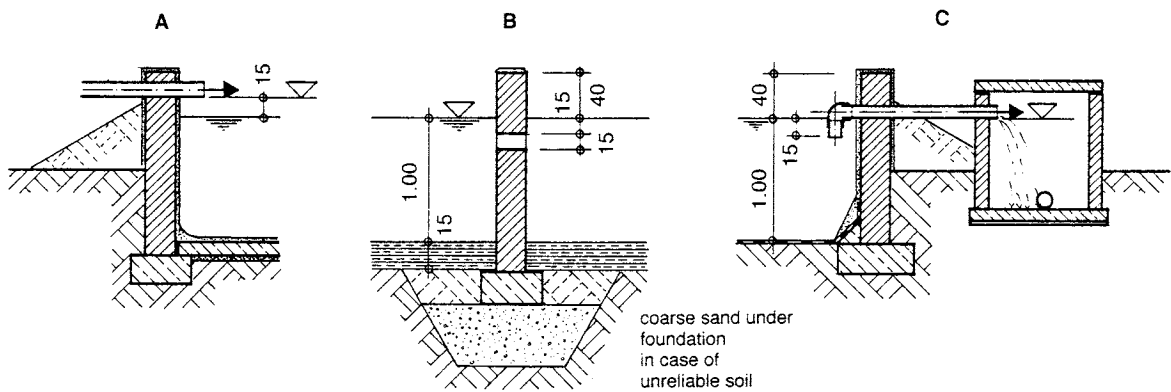

Fig. 45.

Details for aerobic stabilisation ponds (basins) of smaller size. A: Inlet structure, concrete flooring, B: Partition wall, compacted clay flooring, C: Outlet structure, foil flooring (protection against use may be advisable).

Fish feed on algae; but fish can only live if there is enough dissolved oxygen available - 3 mg/l is the absolute minimum for sludge fish. Therefore, the dilution of wastewater by mixing water from other sources (rivers, already existing lakes) becomes necessary failing which, only low organic loading rates are permissible.

Aerobic stabilisation ponds for reasons of oxygen intake should be shallow but deep enough to prevent weed growth at the bottom of the pond. A depth of 90 cm to 1 m in warm climate and up to 1.2 m in cold climate zones (due to frost) is suitable. Deeper ponds become facultative or even anaerobic in the lower strata.

Smaller volumes of wastewater, such as from schools, hospitals, residential houses should better be pre-treated in Imhoff tanks, septic tanks, baffled reactors or at least sedimentation pits, before reaching the aerobic stabilisation pond. Properly operated Imhoff tanks that keep water fresh and without smell are preferable. A septic tank would be better if regular desludging of the Imhoff

tank cannot be guaranteed. The effluent will be "stinky" anyhow. If pre-treatment in ponds does not take place, the pond must be provided with a deeper sedimentation zone near the inlet. However, bad odour is to be expected. It might be wiser to construct a small sedimentation pond on which a sealing scum layer will develop. Should the scum layer become more than 10 cm thick, papyrus that has a beautification effect could be grown on it.

Starting Phase and Maintenance

The pond matures much faster if it is filled with river water before the first wastewater enters. With the exception of regular control of inlet and outlet structures, no permanent attendance is required. However, the performance of the pond should be supervised and any disturbance of the water quality should be carefully investigated to find the cause. Excessive accumulation of sludge could result in inadequate treatment. The pond must be emptied and the sludge must be removed in defined intervals, before treatment quality goes down.

Calculation of Dimensions

Organic surface load and hydraulic retention time are the two design parameters. While minimum hydraulic retention times may be between



Fig. 46.
Papyrus growing on scum of a small sedimentation tank in Auroville / India [photo: Sasse]

5 and 20 days, the maximum organic load depends on ambient temperature (**Tab. 16.**). Sunshine hours are also important but are not included in the calculation. However, ponds should be slightly oversized in areas with permanent cloud cover. Organic loading should better be below 20 g BOD/m²×d. 2.5 to 10 m² pond surface may be calculated per capita for domestic wastewater. All values will depend on the type of pre-treatment and temperature and health objectives. For more exact calculation use the formula applied in the computer spreadsheet (**Tab. 30.**).

9.12.3 Aquatic Plant Systems

Water hyacinth, duck weed, water cabbage and other aquatic plants can improve the treatment capacity of pond systems. Heavy metals that accumulate in water hyacinths are removed when the plants are harvested. Duckweed is a good substitute for algae. Since it is easily retained in a surface baffle, it leaves a cleaner effluent. If not confined in fixed frames, duckweed is blown by wind to the lee-side. Improved treatment efficiency however, is only guaranteed by regular attendance and harvesting. Special design features for harvesting increase the total area requirement of the treatment system. The

Maximum surface load on oxidation ponds 5 days HRT

ambient temper. °C	org.load BOD g/m ² *d
10	7,0
15	11,7
20	17,7
23	21,8
25	24,5
28	28,4
30	30,8
33	33,8

from Mara 1997

evaporation rate of aquatic plant systems is 4 times higher than that of open ponds (in the range of 40 l /m²×d in hot climate).

Tab. 16.
Organic surface loading on aerobic-facultative ponds

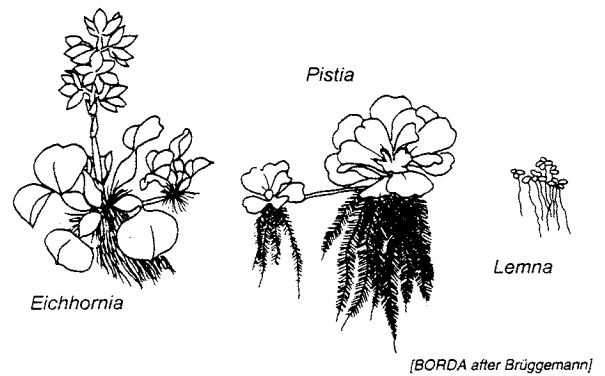

Fig. 47.
Aquatic plants, commonly used for wastewater treatment

The area that is required for a pond is almost the same regardless of aquatic plants. If the organic loading rate is low, plants have the advantage of protecting fish used to control mosquito, from birds. However, some plants, water hyacinth for example, are a disadvantage as they shelter mosquito larva from fish. Snakes also find shelter. High organic loading rates that may be why additional treatment by aquatic plants is sought, do not allow survival of fish for mosquito control.

Since aquatic plant systems become a nuisance if not properly taken care of, they are not considered as DEWATS. However, aquatic plants make sense if utilised in conjunction with wastewater farming which uses intensive and controlled nutrient recycling, or for the purpose of beautifying residences that are nearby.

Starting Phase and Maintenance

Maintenance and operation is mainly an issue of agricultural management rather, than an issue of wastewater treatment. The pond should be started with fresh, river water and the pollution load should be applied

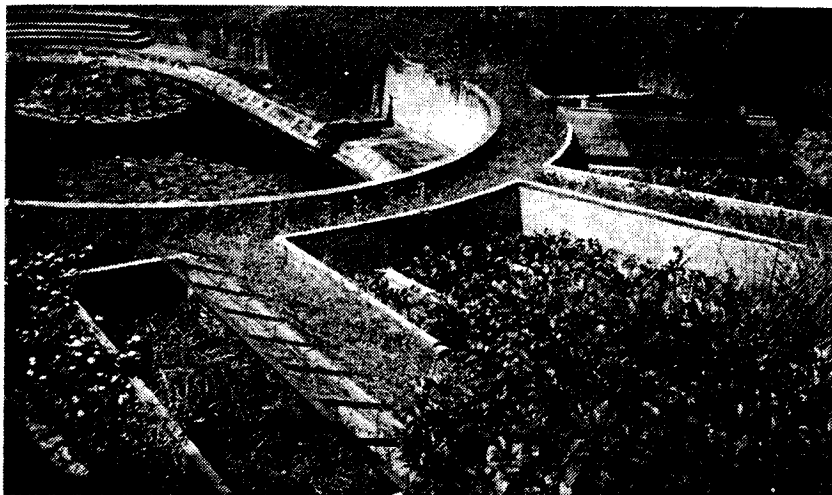

Fig. 48. Wastewater treatment tanks using aquatic plants in Auroville / India. The plant is placed directly beside residential houses. Lizards which live among the water hyacinth take care of mosquito control. The first settling tank is sealed against bad odour by a thick layer of scum on which papyrus grows (see Fig. 46). [photo: Sasse]

slowly while the plants cover the pond. Plants must be harvested regularly in order to prevent dead plants forming bottom sludge. Duckweed, in particular should be kept in frames that prevent them from being pushed to one side by the wind. Inlet and outlet structures should be controlled as in normal oxidation ponds.

Calculation of Dimensions

For practical reasons, the same formula that is used for unplanted oxidation ponds may be used (Tab. 30).

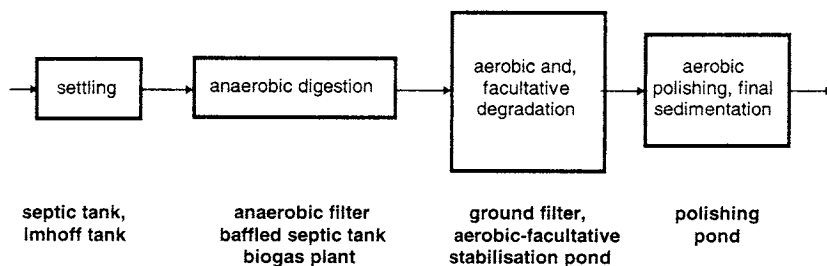
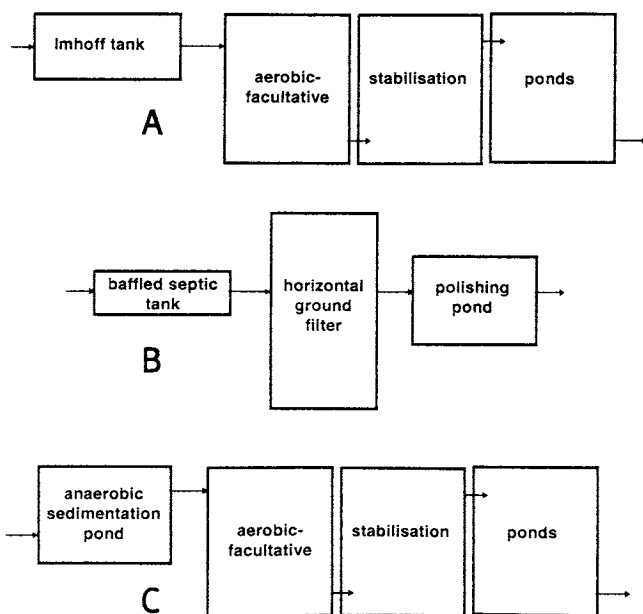

Fig. 49. The complete treatment chain of DEWATS-technology



9.13 Hybrid and Combined Systems

Each technology has particular strong and weak points. Therefore it makes sense to combine different treatment systems, for example sedimentation in a settler or septic tank followed by anaerobic decomposition of non-settleable suspended solids in anaerobic filters or baffled septic tanks.

Fig. 50. Typical combinations for full treatment when using DEWATS-technology

Further treatment may require aerobic conditions for which ponds or ground filters may be chosen. Purpose of treatment and site conditions define those technologies which are appropriate for application.

Apart from combining pre-treatment with post-treatment technologies, other features may be combined also. As known from the hybrid UASB one may as well combine the baffled septic tank with the anaerobic filter by adding filters in the last chambers of the baffled septic tank (*Fig. 51*). If floating filter medium is available, one may provide a thin filter layer at the top of each baffled chamber.

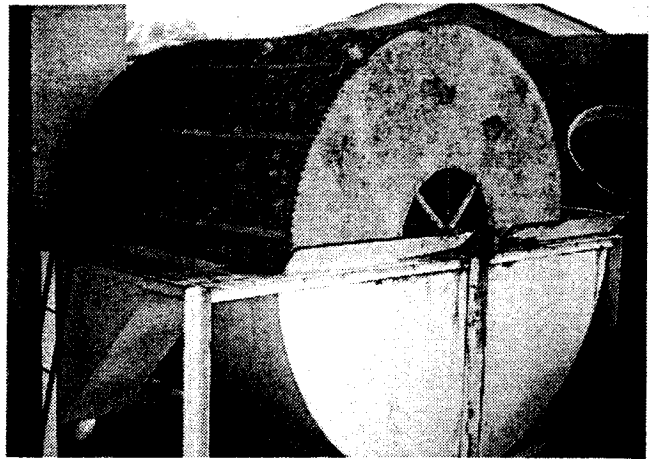

Fig. 52.
Rotating disk reactor in a slaughter house in Jakarta, Indonesia. The reactor was temporarily out of use when the photograph was taken. [photo: Sasse]

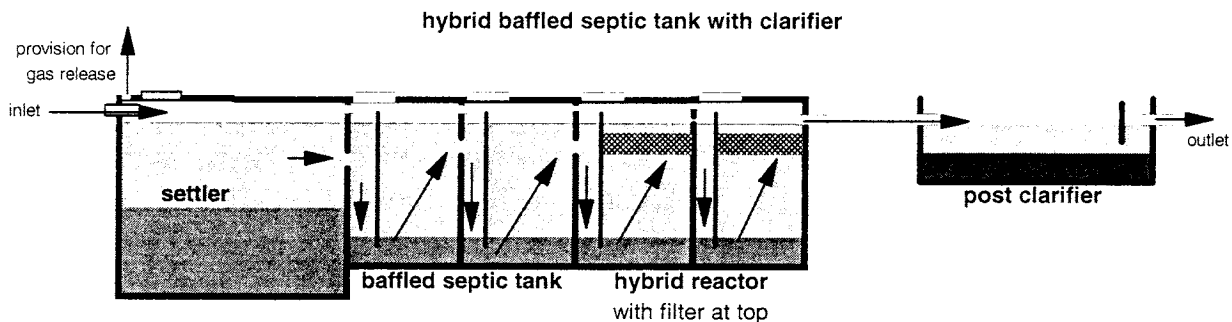

Fig. 51.
An example of a hybrid and combined reactor

9.14 Unsuitable Technologies

DEWATS commands low maintenance. This implies that technologies which cannot be "switched on and off" as one likes, is integral to the DEWATS concept. DEWATS are intended to function every day with the efficiency envisaged. Systems, which are highly efficient but require a great deal of regular care to function at an acceptable level, do not suit the concept of decentralised wastewater treatment. To avoid any misunderstanding: The technologies which

are regarded here as non-DEWATS are by no means inferior treatment systems. They may even be used in a decentralised concept. However, not without highly qualified operational staff which is closely supervised by an experienced management.

The technologies that do not fit in with DEWATS are:

- the rotating disc reactor
- the trickling filter
- the activated sludge process
- the fluidised bed reactor
- the sequencing batch reactor

Those systems which work with compressed air - either for aeration or floatation - or require chemicals for treatment are also excluded from DEWATS. The UASB is also not suitable, despite its simple technology. High

What will not be maintained, does not need to be built

rate trickling filters may be suitable when the distribution system functions permanently. Similarly, vertical planted filter beds

may be suitable if alternate charging of filter beds is incorporated into the "production process" of wastewater itself.

The choice of treatment system will depend on the management capacity at site. General recommendations could at best only rank the treatment systems. Much depends on site conditions. For instance, even horizontal ground filters can fail if grain size or surface area is insufficient. In situations where little to no care is to be expected, only ponds, septic tanks and baffled septic tanks would be worth the investment. But of course, it might be difficult for the planning engineer to tell the client that he considers him being careless.

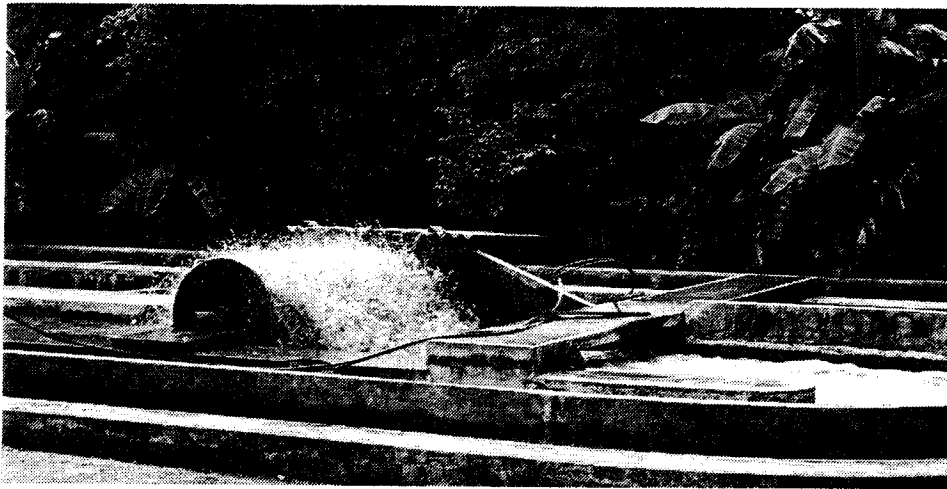

Fig. 53.
Oxidation ditch operated at a rubber factory in Kerala / India [photo: Sasse]

10 SLUDGE DISPOSAL

10.1 Desludging

All organic degradation processes produce sludge. The sludge produced by anaerobic treatment is less than that produced by aerobic treatment. The greater the treatment efficiency the greater the sludge production. So as not to occupy reactor volume, sludge must be removed at intervals of 1/2 to 3 years in tanks and in 1 to 20 years in ponds. Sludge from industrial processes may be removed in intervals of one to seven days, only. In such case, the sludge is not stabilised and should be treated further in anaerobic digesters or must be composted immediately. Sludge, which is not fully stabilised, should not be dried in the open because of bad odour and the nuisance from flies.

Bottom sludge from domestic and husbandry wastewater is highly contaminated by worm eggs and cysts and should be handled hygienically. From a technical point of view, desludging of septic tanks, baffled septic tanks and anaerobic filters can be done with buckets, by pumping or by hydraulic pressure. What is important is that only the oldest sludge is removed and that the active sludge which is composed of living bacteria is left behind in the tank. With use of buckets - beside the obvious health risk - there is always the danger of removing the active sludge together with the oldest sludge, as the old sludge is always found below the active sludge.

Pump heads must be pushed down to the bottom of the tank in order to reach the oldest sludge. The effluent at the pump

outlet should always be visible in order to check and control the colour and consistency of the sludge. When the colour of the effluent becomes too light, pumping must be stopped for a while to give the sludge time to flow to the mouth of the pump once again. Free flow rotary pumps that allow sand, grit and smaller solid particles to pass through without blockage are best for desludging.



Fig. 54.
Flexible pipes for de-sludging. Sludge is discharged by hydraulic pressure when lowering the pipe. [photo: Sasse]

Old bottom sludge, because it compacts with time through its own weight, can be rather "thick". Consequently, desludging pipes which work by hydraulic pressure must

be of large diameter. The diameter of a desludging pipe should not be below 100 mm; 150 mm would be better still. The hydraulic head loss is in the range of 15 to 20%. For a 2,50 m long pipe, the outlet must be 0.35 to 0.50 m below the normal wastewater outlet. The desludging pipe is best equipped with a gate valve, which has a free opening of the full diameter. It is also possible to fit flexible pipes at the upper end of the down pipe. This would ensure that sludge flows out when the flexible outlet is lowered. However, pipes of such large diameter are not very flexible, requiring that the connection between the flexible hose and the rigid pipe is strong and durable. Flexible desludging pipes must be closed and locked when not in use and handle of valves must be removed in order to prevent mischief by children.

10.2 Sludge Drying

Sludge has a total solid content of 2 to 10%. This means that it is rather liquid and cannot be transported easily with simple equipment. Apart from this, sludge is contaminated and occupies large volumes for storage. Therefore, it would be better to dry sludge before further use or final dumping. Only sludge that has stabilised - free from bad odour - should be dried in open beds. Anaerobic sludge dries best.

It is best to dry sludge in the immediate vicinity of the plant from which it has been removed. In case of domestic wastewater this could mean that drying places would then be directly near residential houses. This

is not a problem if the sludge is spread as fertiliser on flowerbeds, as a thin layer of sludge dries immediately. The slight foul smell once a year may in most cases be acceptable, nor should the somewhat theoretical health risk be overestimated as in the case of a pet strolling through the flowers. However, drying sludge in sand beds at residential sites is problematic since the usual sludge depth of 20 cm would need several weeks to dry. It would disturb children when playing in the vicinity and draw the ire of those residents who are particular about a clean environment. Therefore, sludge may have to be transported by tankers to a suitable drying place.

Drying itself is no problem on special drying beds in hot and dry climate but needs some consideration in case of moderate temperature, frequent rain or high humidity. One layer of sludge should not exceed 20 cm,

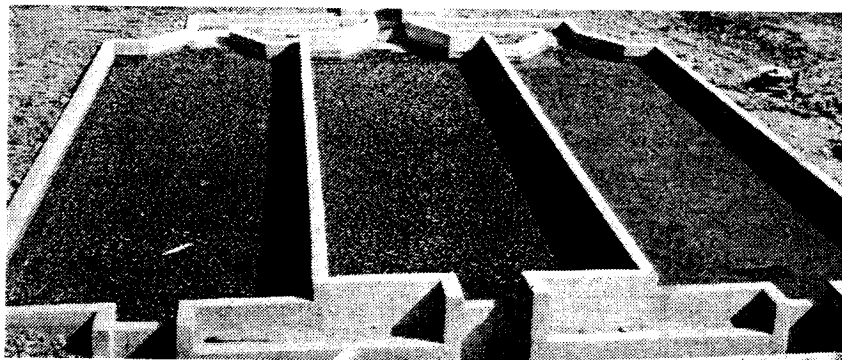

Fig. 55. Sludge drying beds constructed by University of Chiang Mei and GTZ in Thailand [photo: Sasse]

five loads per year from five different plants may be possible at the same bed. This means 1 m³ of sludge needs about 1 m² of drying surface. However, at least 5 m² are needed per m³ of sludge when sludge from only one plant is dumped at a time.

Drying beds consist of about 30 cm coarse aggregate (>50 mm diameter) or gravel, covered with 10 to 15 cm coarse sand. Drainage pipes are imbedded in the bottom layer. The bottom must be sealed when contamination of ground water would be possible. Drying beds with slightly sloped surface are easier to drain than completely horizontal beds. Sludge drying beds should be roofed at places of frequent rain.

principle cross section of sludge drying bed

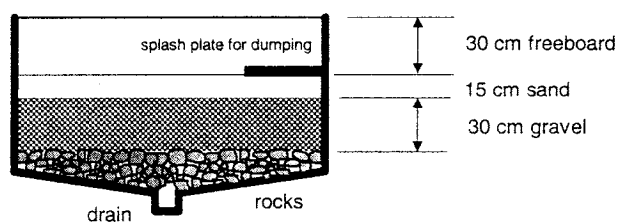

Fig. 56.

Principle cross section of a sludge drying bed

10.3 Composting

Composting of sludge is advisable for hygienic reasons, especially in case of domestic and husbandry wastewater. Improving fertiliser quality may be a by-product, but has normally no primary importance to the client. In respect to DEWATS the question is first how to get rid of the sludge. Composting is a good method for that, because compost is not only hygienically safer, it is also better to handle by small farmers, because it can be carried by buckets.

The amount of compost one may get per year from 20 m³ of domestic wastewater per day is in the range of 25 m³, which shrinks to approximately 12.5 m³ after maturation. This volume lasts for less than a quarter acre, which indicates that compost

from an average DEWATS can only add to, but not fully substitute other fertiliser, even for a small farmer. However, compost has its value as fertiliser and soil conditioner, and therefore should be honoured as a resource, and not disregarded as a waste.

Composting requires soil or dry organic matter, for example straw, to be mixed with in order to reach 50% TS content. Such high total solids content is needed for a loosely packed consistency which is required for ventilation (aeration), while the moisture is needed to provide a suitable environment for aerobic bacteria.

Compost is best prepared by pouring liquid sludge on dry organic matter in several layers of 10 to 20 cm. The heap is then covered with soil. The compost should be turned over several times during maturation in order to distribute active bacteria all within the substrate, and to provide oxygen to deeper layers. Rising temperature is the best sign for the aerobe decomposition process. Temperature drops after maturation, which might be after three months up to one year under farm conditions.

A properly heaped compost produces a reaction temperature of up to 70°C. The high temperature over several weeks of maturation has a sterilising effect on pathogens, including helminths and ova. However, care must be taken during preparation of compost.

Compost is needed at a certain time from an agricultural point of view. Desludging must be done before that date, in order to allow time for composting. Annual desludging is convenient for the farmer, but may not be convenient for the plant operator. Longer desludging intervals produce a more safe sludge, than shorter intervals and

thus, may be recommended from a hygienic point of view. However, the operator of the treatment plant has to organise the whereabouts of his sludge and should come to an agreement with either the farmer directly or with a transporting enterprise which collects the sludge at suitable times.

If composting is not possible but sludge is to be used fresh on agricultural land, then sludge must be disposed in trenches which are covered by 25 cm of soil, at least.

11 REUSE OF WASTEWATER AND SLUDGE

11. 1 Risks

The risk that the use of wastewater for purposes of irrigation can mean to soil is described in chapter 6.. However, as was said before, fresh or pre-treated wastewater if handled properly can be a valuable agricultural input.

Wastewater is never safe water

Wastewater is never hygienically safe. Proper handling of wastewater and sludge is the only successful preventive health method. The farmer who uses wastewater for irrigation must consider the risk to his own health and to the health of those who consume the crops grown by him. He must therefore check whether the wastewater he uses for irrigation is suitable to the crops or pasture ground he intends to water.

Tab. 17.
Survival of pathogens

Common survival times of pathogens				
pathogens	in sludge and water		in soil	on plants
	10-15°C < days	< days	20-30°C ¹⁾ < days	< days
virus	100	20	20	15
bacteria				
salmonella	100	30	20	15
cholera	30	5	10	2
fecal coli	150	50	20	15
protozoae				
amoebae cyst	30	15	10	2
worms				
ascari ova	700	360	180	30
tape worm ova	360	180	180	30

¹⁾ not exposed to direct sun light

Fresh, untreated domestic and agricultural wastewater contains over one million bacteria per millilitre, thousands of which are pathogens - both bacteria and virus. Eggs of worms are found in the range of 1000 per litre. Epidemical statistics reveal that helminthic (intestinal worm's) infection presents the most common risk from irrigation with untreated wastewater. The risk of bacterial infection comes followed by the risk of virus infection, which is the lowest. Although the removal rates in anaerobic systems are usually over 95%, many pathogens remain even after treatment. The effluent from oxidation ponds is less pathogenic.

The World Health Organisation (WHO) recommends that treated wastewater for unrestricted irrigation should contain less than 10.000 fecal coliforms per litre (1000/100 ml), and less than 1 helminth egg per litre. This limit should be observed strictly since the risk of transmitting parasites is relatively high.

In this regard, there are a few mechanisms and rules to be learnt and practiced. Eggs and larvae settle with sludge within which they may remain alive for many weeks. This explains their high concentration in the sludge. Nonetheless, eggs and larvae do not survive high temperatures; they die. It is for this reason that sludge should be composted before use. Spreading sludge out on the field and exposing it to the sun is another way

EAWAG

of killing the unwanted organisms. In the later case, nitrogen is lost and the fertiliser value is reduced.

Pathogenic bacteria and viruses are not greatly effected in anaerobic filters or septic tanks because they remain in the treatment plant for only a few hours before they are expelled together with the liquid that exits the plant. Post treatment in a shallow pond that ensures exposure to the sun reduces the number of bacteria considerably.

Those farmers who use sewage water for farming or sludge as a fertiliser are exposed to certain permanent health risks. These health risks are controlled within organised and specialised wastewater farming or within commercial horticulture, because of certain protective measures that are taken, such as the use of boots and gloves by the workers and the transportation of the wastewater in piped systems. However, such precautions are very unlikely in small-scale farming. Plants are either watered individually with the help of buckets or trench irrigation is used. The flow of water is usually controlled by small dykes which are put together by bare hand or bare foot whereby direct contact with pathogens is hardly avoidable.

A shallow storage pond to keep water standing for a day or more before it is used may minimise the number of pathogens, but would hardly reduce the indirect health risk. It is also likely that children will take to playing, ducks will come to swim and animals may start to drink from such an arrangement. Fencing may help. The more foolproof preventive measure may be a permanent repetitive health education programme that reminds users of the dangers and precautionary measures to be taken.

Tab. 18.

WHO-guide lines for wastewater use in agriculture

WHO guide lines for wastewater use in agriculture		
category	reuse conditions	treatment required
A	irrigation of crops to be eaten uncooked, sports fields, public parks	series of stabilisation ponds
B	irrigation of cereal- industrial- and fodder crops, pasture and trees	10 days retention in stabilisation ponds
C	localised irrigation of crops of category B, no contact by workers or public	at least primary sedimentation

WHO 1989

Consumers of crops grown by such means and animals that graze on pastures that are irrigated with wastewater are also endangered. Since bacteria and virus are killed by a few hours, or at most a few days of exposure to air, wastewater should not be spread on plants which are eaten raw (e.g. lettuce) for at least two weeks prior to harvesting. India has prohibited the use of wastewater irrigation for crops that are likely to be consumed uncooked.

Since bacteria and virus stay alive much longer when wastewater percolates into the ground, root crops like potatoes or carrots except for seeds or seedlings should not be irrigated with wastewater.

11.2 Groundwater Recharge

Recharge of groundwater is probably the best way to reuse wastewater particularly since the groundwater table tends to lower almost everywhere. Wastewater had been freshwater, and freshwater drawn from wells has been groundwater before. Sustainable

development is directly related to the availability of water from the ground. Thus, recharging of this source becomes absolutely vital to human civilisation. The main question is how far the wastewater needs treatment before it may be discharged to the ground. For that please refer to chapter 6.

11.3 Fishponds

Wastewater is full of nutrients which can directly be used by algae, water plants and lower animals which then could become fish feed. But fish need also oxygen to breath, which must be dissolved in water in pure form of O_2 (4 mg/l for carp species, > 6 mg/l for trout species). Since free oxygen is needed for degradation of the organic matter present in wastewater, it cannot be expected to be in sufficient supply for the survival of fish. Therefore, pre-treated wastewater must be mixed with freshwater from rivers or lakes, otherwise wastewater ponds must become so large that oxygen supply via pond surface overrules the oxygen demand of the organic load.

Organic load on fishponds should be below 5g BOD/ $m^2 \times d$ before 5 times dilution with freshwater. This implies that if the chances of dilution are non-existent, the organic load may be 1 g BOD/ $m^2 \times d$.

If possible, there should be several inlet points in order to distribute organic matter more equally where it comes into contact with oxygen quickly. It had been mentioned before that turbulent surface increases the oxygen intake, and cooler temperature increases the ability to store free oxygen in water. However, it is not worthwhile trying to increase oxygen intake by special shaped inlet structures or similar measures. In a

stage where oxygen deficiency can only be little, oxygen absorption is also little.

The pH should be 7 - 8. Fish culture is not possible when wastewater may be toxic or polluted by mineral oils, temporarily or permanently.

Mixing of wastewater with fresh water should not happen before the fishpond. Otherwise wastewater nutrients would initiate heavy growth of fungi, algae and other species without being consumed by fish. When starting a fishpond, it first should be filled with fresh water, wastewater is added later.

When using natural lakes for wastewater based fishery it should be known, whether the lake is legally considered being part of the treatment system or already part of the environment in which wastewater is discharged. With other words, it must be clear whether discharge standards must be observed at the inlet or whether the effluent of the lake will do.

Kind and condition of fishes are an indicator of water quality. Carp species can live in water with lower oxygen content and are most common in wastewater based fish culture. Tilapia has become the most common "Development Project-Fish" and is also growing well in wastewater ponds. Tench species often have difficulties to survive, because they take feed from the ground and get problems with anaerobic bottom sludge. It is advisable to empty the ponds once every year in order to remove sludge or at least to expose the bottom sludge to oxygen for stabilisation.

Fish ponds are normally more turbid than other ponds, because fish swirl up sludge from the ground. Trout species survive surprisingly well, despite higher turbidity, when

oxygen content is sufficient. However, it should be clear that more specified knowledge on fish species, fish production and marketing is needed than can be read from this chapter. More information is available from regional offices of fishery departments and should be requested from there before starting a wastewater fish farming system.

Fishponds have a hydraulic retention time of 3 to 10 days and a depth of 0.5 - 0.8 m. Net fish production is about 500 kg/ha (50 g/m²), 900 to 1200 kg/ha are said to be harvested from Calcutta's municipality fish farm. There is also the possibility of raising fish in 2.5 - 3 m deep ponds where different kind of fish live in different strata of the pond. An almost unbelievable 12.000 kg/ha are claimed to have been harvested in Brazil in such ponds per annum. Higher fish population produces more sludge which reduces the amount of free oxygen. Whether wastewater based fishery becomes a viable

business depends on market price of fish and operational cost for fishery. Fingerlings must be kept separate because fish, when set free, should have 350 g life weight in order to be too heavy for fishing birds. Losses can reach 50% when fish ponds become an ecological niche which attracts fish hunting birds.

Fish lose the foul taste of wastewater when kept for some days in fresh water before consumption. This reduces also the risk of pathogen transfer. Fishermen during harvest should be aware that fish live in wastewater which bears always a certain, albeit small, health risk.

11.4 Irrigation

Treated domestic or mixed community wastewater is ideal for irrigating parks and flower gardens. Irrigation normally happens there in the evening or early morning when nobody is bothered, even not by the slightly foul smell of anaerobic effluent. Nonetheless, irrigation of public parks is often legally forbidden.

For an irrigation rate of 2 m per year (20.000 m³/ha) which is commonly required in semi-arid areas, even well treated wastewater with as low concentrations as 15 mg/l of total nitrogen and 3 mg/l total phosphorus provides 300 kg N and 60 kg P per ha via irrigation without additional cost; at the same time the respective amount of groundwater is saved. Not only water but energy for pumping is saved also. In areas of plenty of rainfall less water is applied for irrigation and use of pre-settled but otherwise fresh wastewater may be more appropriate with respect to fertiliser. With 0.1 m per year (1,000 m³/ha) of fresh wastewater for irriga-

Tab. 19.
Fertiliser value of sewage sludge

kind of nutrient	Sewage sludge as fertiliser	
	average nutrient content in 1000 kg of sewage sludge (10% TS) grams	1000 kg of farm yard manure grams
N	5,5	17,5
P ₂ O ₅	17,5	17,5
K ₂ O	0,75	65
S (total)	12,5	25
MgO	30	15
Cu (total)	1,2	0,03
Zn (total)	1,5	0,15
Mn (total)	0,6	0,4
Mo (total)	0,01	0,001
B (total)	0,03	0,035

Mudrak / Kunst, pg. 162

tion, some 60 kg nitrogen, 15 kg phosphorus and a similar amount of potassium could be applied per ha. However, domestic wastewater in modern households sometimes lacks potassium which might need to be added to mobilise nitrogen and phosphorus.

This booklet deals with wastewater, it cannot provide sufficient information on general or specific local questions of agriculture or nutrient requirements of different crop. Each farmer has to find out his own method and his own way of using efficient and safe quantities of water. The practical farmer knows which nutrients are needed for which crop and a studied agriculturist would also know from the result of wastewater analysis whether the composition of nutrients and trace elements suits the proposed plantation. He will also know from that analysis whether too much of toxic elements are remaining in the water (toxic elements might be there if the COD is much higher than the BOD). Such tests are advisable when using industrial or hospital wastewater for the first time. The responsible person of the wastewater source is obliged to inform farmers about toxic or otherwise dangerous substances in the effluent, for example radioactive elements from x-ray laboratories.

Original saline water will remain saline even after intensive treatment. Copper and other metals, especially heavy metals accumulate in the soil. Long term application of such water will spoil the soil forever.

11.5 Reuse for Process and Domestic Purposes

Pathogenic wastewater, this is from domestic sources, slaughter houses or animal stables should better not be reused for other purposes, except for irrigation. Partly treated organic wastewater (this is more or less all wastewater from DEWATS-treatment) should as well better not be reused as process water in industries or as flushing water in toilets. Reuse of wastewater means always some traces of organic matter or toxic substances present or even accumulating. Reuse means as well longer retention times in a closed system which might facilitate anaerobic processes within pipes and tanks which will cause corrosion. There is also a theoretical risk of biogas explosion.

To suppress organic decay one may have to add lime, which might form lime stone inside the system, or other inhibiting substances which would make proper final treatment of wastewater costly. For example, even the first washing water in a fruit processing plant or in a potato chip plant might contain already too much organic matter for any reuse without adding lime to oppress fermentation.

The chance of re-circulation of parts of the water to serve the production process is limited, especially when the wastewater engineer and the production engineer have limited theoretical knowledge. Pollution content and degree of possible treatment, as well as demand of water for consumption and the wastewater flow over a given period of one day (or one season) must be investigated. Construction of intermediate water stores and installing additional pumps may become necessary, as well. Reuse of wastewater is an option which sounds very

reasonable in the context of sustainable development. However, the problems which go along with it do not allow to recommend any reuse, in general.

Reuse of industrial wastewater which is only slightly polluted and where pollution might not even be of organic nature, is a completely different matter. For example, press water in a soap factory may be reused for mixing the next load of soap paste. All wa-

ter consuming modern industries have reduced their water consumption considerably in the last years. In most countries, amongst them India and China, water consumption limits are obligatory for many industrial processes; such as sugar refineries, breweries, canning factories, etc.. Saving water in the process is always the better alternative, instead of reusing water which had been carelessly wasted and polluted.

12 BIOGAS UTILISATION

Biogas

All anaerobic systems produce biogas. 55% - 75% of methane (CH₄), 25% - 45% of carbohydrate (CO₂) plus traces of H₂S, H₂, NH₃ go to form biogas. The mild but typical foul smell of biogas is due to the hydro-sulphur, which after it is transformed into H₂SO₃, is also responsible for the corrosive nature of biogas. The composition rate of biogas depends on the properties of wastewater and on the design of the reactor, i.e. the retention time. Theoretically, the rate of methane production is 350 l per kg removed BOD_{total}. In practice however, methane production should be compared to 1 kg removed COD of which values are closer to the removed BOD_{total} than to the removed BOD₅ (see Fig. 14.). By doing so, one assumes that during anaerobic digestion only

biodegradable COD is removed, which is involved in the production of methane. In reality, the gas production rates are lower than this because a part of the biogas dissolves in water and cannot be collected in gaseous form. It is also common to relate biogas production to organic dry matter in case of very strong viscous substrate, 300 - 450 l biogas per kg DM can be expected.

The calorific value of methane is 35.8 MJ/m³ (9.94 kwh/m³). The calorific value of biogas depends on the methane content. Hydrogen has practically no role. As a rule of thumb, 1 m³ biogas can substitute 5 kg of firewood or 0.6 l of diesel fuel.

Methane damages the ozone layer of the atmosphere. From an environmental point of view it should be burnt to become harmless. Only CO₂ and water remain on burning methane. Since the residual CO₂ does not stem from fossil sources, it is harmless to the atmosphere.

Tab. 20.

Potential biogas production from some selected industrial processes

Biogas production from industrial processes

industry	COD per product kg / to	COD removal %	relative gas production m ³ CH ₄ / kg COD _{in}	methane content %
beet sugar	6-8	70-90	0,24-0,32	65-85
starch - potato	30-40	75-85	0,26-0,30	75-85
starch wheat	100-120	80-95	0,28-0,33	55-65
starch - maize	8-17	80-90	0,28-0,32	65-75
melasses	180-250	60-75	0,21-0,26	60-70
distillery - potato	50-70	55-65	0,19-0,23	65-70
distillery - corn	180-200	55-65	0,19-0,23	65-70
pectine		75-80	0,26-0,28	50-60
potato processing	15-25	70-90	0,24-0,32	70-80
sour pickles	15-20	80-90	0,28-0,28	70-75
juice	2-6	70-85	0,24-0,30	70-80
milk processing	1-6	70-80	0,24-0,28	65-75
breweries	5-10	70-85	0,24-0,33	75-85
slaughter	5-10	75-90	0,26-0,32	80-85
cellulose	110-125	75-90	0,26-0,33	70-75
paper / board	4-30	60-80	0,21-0,28	70-80

ATV, BDE, VKS

12.2 Scope of Use

Biogas may be used in burners for cooking or in combustion engines to generate power. The use of biogas will depend on the regularity of biogas supply and its availability to meet the minimum requirement of a particular use. If biogas cannot be utilised, it should be released in the air by safe ventilation. It is not meaningful to collect, store and distribute biogas

when it does not meet any real purpose, in which case it would not be used anyhow.

What will not be used, does not need to be built

which is methane. In

are lower The extraction of carbohydrate (CO_2) biogas dis-fore the utilisation of biogas is not essential. However it might be advisable to relate move an unusually high H_2S content with matter in the help of iron oxide. Biogas flows through rate, 300 a drum or pipe filled with iron oxide (e.g. expected. rusted iron borings). The oxygen reacts with 5.8 MJ/m^3 the hydrogen to form water, while sulphur and iron (or sulphide of iron) remain. The hydrogen iron may be reused after again becoming of thumb, rusty due to exposure to air.

firewood The minimum requirement of biogas for a household kitchen is approximately $2 \text{ m}^3/\text{d}$; er of the below which meaningful use is rare. Approx-ital point mately 20 to 30 m^3 of domestic wastewater me harm-are required daily to produce the minimum on burn-amount of gas. From an economical point of CO_2 doesview, biogas utilisation from wastewater harmlessbecomes meaningful if the strength of the wastewater is at least 1000 mg/l COD and the regular daily flow is 20 m^3 . For more information see chapter 4.

burners The best way of using biogas is for heat mbustion principle and can be self-made from con-ower. The verted LPG-burners. There are many fields depend on in which biogas can be used: cooking in as supply households and canteens or drying and meet the heating as part of industrial processes, are of a par-some examples. The best use of biogas cannot be would be as fuel for the very process that released produces the wastewater.

ntilation. It is also possible to use biogas for direct o collect, lighting in gas lamps. It is only meaningful e biogasto do so in the absence of electricity sup-

ply, or frequent power cuts that justify the investment. The light from a biogas lamp cannot compete in quality and comfort with an electric light.

Biogas may be used as fuel in diesel engines and Otto motors. As the ignition point of biogas is rather high, it does not explode under pressure of a normal diesel engine. Therefore, approximately 20% of diesel must be used for ignition, together with biogas. Diesel engines are most suitable as they can be run only on diesel in case of irregular biogas supply. Further, the slow flame speed of biogas is better suited to the slow revolving diesel engine than Otto motors. Biogas would not have enough time to burn completely with engines that run with more than 2000 revolutions per minute.

It would be self-defeating to produce and use biogas for the purpose of meaningless demonstration. The only exception may be to aid natural science teaching in secondary schools.

12.3 Gas Collection and Storage

Biogas is produced within wastewater and sludge, from where it rises in bubbles to the surface. The gas must be collected above the surface and stored until it is ready for use. Even when gas production is regular, the accumulation of useable gas is irregular. Gas bubbles cause turbulence which leads to the explosive release of gas in a chain reaction. Stirring of substrate, especially stirring of sludge, has a similar effect. As a result of this effect, gas production fluctuates by plus/minus 25% from one day to the other. The volume of gas storage must provide for this fluctuation.

The volume of gas in stock changes according to gas production and the pattern of gas consumption. With rigid structures, the volume of the storage tank either changes with changing volume of gas present, or the gas pressure increases along with the stored volume. In fixed dome plants, and with flexible material such as plastic foils, both the volume and the pressure fluctuates. There are two main systems for rigid materials, namely:

- the floating drum and
- the fixed dome

For flexible material there are two variants, as well, namely

- the balloon, and
- the tent above water

The **floating drum** (Fig. 29. (C)) is a tank that floats on water, the bottom of which is open. The actual storage volume changes together with the amount of gas available and the drum rises above the water accord-

ing to gas volume. The drum is normally made out of steel. To avoid corrosion, materials such as ferro-cement, HDP and fibreglass have also been tried. As a rule, only very experienced workshops have been successful with such material. Most find leakage a problem. The gas pressure is created by the weight of the drum (the weight is to be divided by the occupied surface area to calculate the pressure). A safety valve is not required as surplus gas is released under the rim when the drum rises beyond a point.

The **fixed dome** principle (Fig. 29. (A) + (B)) has been developed for biogas digesters for rural households as an alternative to the corrosion problem of the floating drum. The fixed dome plant follows the principle of displacing liquid substrate through gas pressure. The gas pressure is created by the difference in liquid level between the inside and outside of the closed vessel. In case of very high gas pressure, the outlet pipe functions as a safety valve. Therefore, the inner level of the outlet pipe must be higher than that of the inlet.

In biogas plants of a relatively high gas production compared to the volume of substrate, an expansion chamber is needed to sustain gas pressure during



Fig. 57. Floating drum plant. The drums are lifted for re-painting which allows a view on the double ring wall of the water jacket. Constructed by LPTP and BORDA for a slaughter house in Java / Indonesia. [photo: Sasse]



Fig. 58.
Fixed dome biogas plant for cattle dung, under construction by CYSD and BORDA at a farm in Orissa / India [photo: Sasse]

use. In case of wastewater, where the volume of water is relatively large compared to the volume of gas production, an expansion chamber may be not required because the in-flowing wastewater replaces the wastewater, which has been pushed out by the gas. For this reason, the correspondence of the time of gas consumption with the time of intensive wastewater inflow is important. An expansion chamber is required in cases when there is little to no wastewater flow during gas consumption. An expansion chamber is not required when the simultaneous volume of consumed gas is less than volume of wastewater inflow.

The surface area of an anaerobic treatment tank is relatively large compared to the amount of biogas produced. Consequently, fluctuation in liquid level due to variation in gas volumes in the upper part of the reactor is respectively small. All the same, it may

influence the design, especially the level of baffles to retain floating solids.

Biogas is an end product of decomposition and therefore, has very fine molecules that can pass through the smallest crack and the finest hole. Gas storage must be constructed as gas tight as a bicycle tube for example. The usual quality of concrete and masonry is not sufficiently gas-tight. Bricks are porous and concrete has cracks. Therefore, bricks and

concrete must be well plastered by applying several layers and adding special compounds to the mortar in order to minimise shrinking rates. Several layers of plaster help to cover cracks of one layer with the next layer of plaster, hoping that cracks in different layers do not appear at the same spot.

Tab. 21.
Prescription for gas-tight plaster. The method had been developed by CAMARTEC/GTZ in Arusha / Tanzania and is successfully applied since 1989 in many countries.

Typical prescription for gas-tight plaster in fixed dome biogas plants	
1st layer	cement - water brushing
2nd layer	cement plaster 1 : 2,5
3rd layer	cement water brushing
4th layer	cement plaster 1 : 2,5 with water proof compound
5th layer	cement - water brushing with water proof compound
6th layer	cement plaster 1 : 2,5 with water proof compound
7th layer	cement - water finish with water proof compound

CAMARTEC, BORDA

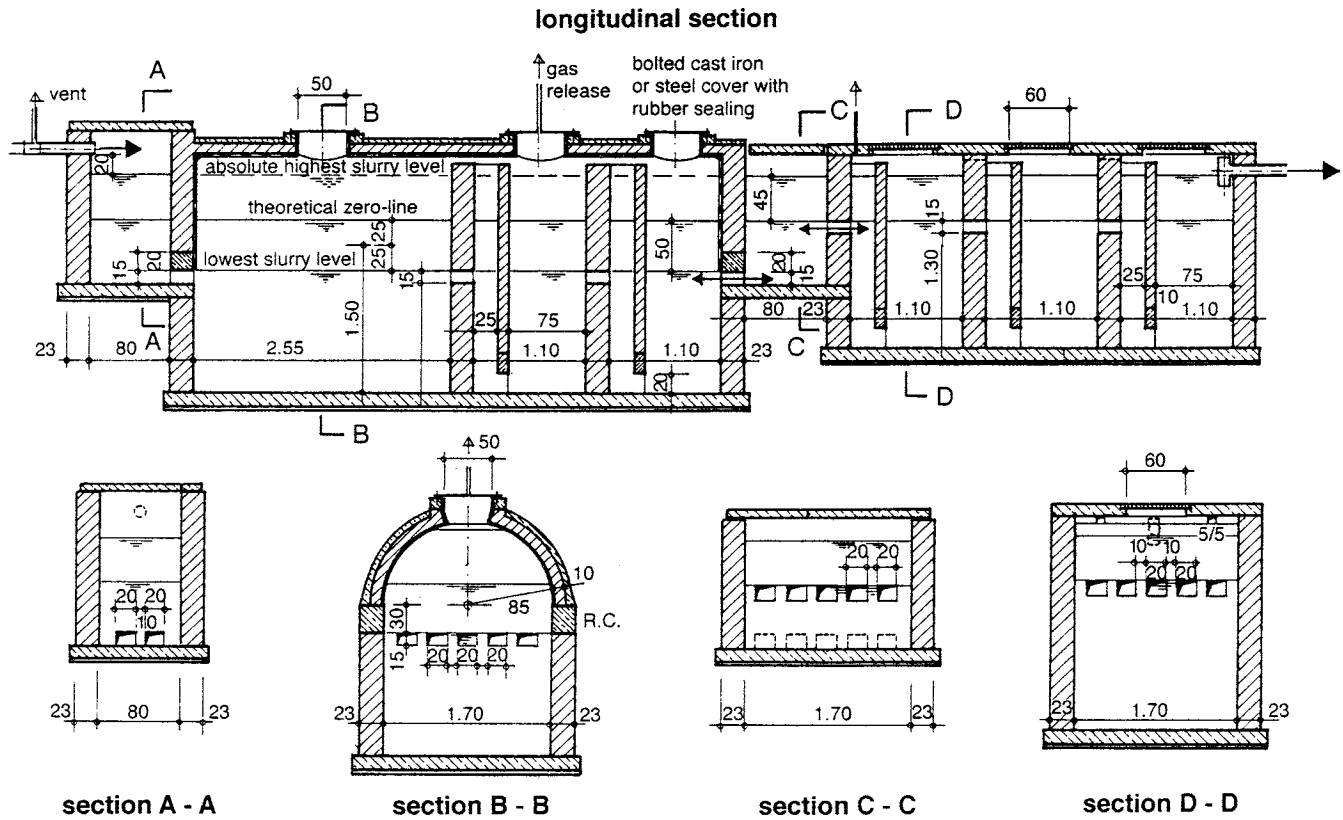
**Fig. 59.**

Baffled septic tank with biogas utilisation. Only biogas from the settler and the first two baffled chambers is used. They are arched in order to guarantee a gas-tight structure. The tanks which store biogas are separated from the three chambers at the rear of which biogas is not collected. The design is based on 25 m³ daily wastewater flow, 4000 mg/l COD and a necessary gas storage volume of 8 m³.

A structure under pressure cannot develop cracks, therefore the structure of the gas storage should be under pressure whenever possible. This is the reason why anaerobic reactors should have arched ceilings, where heavy soil covering creates the required pressure. Normally, baffled septic tanks and anaerobic filters are rectangular in shape. Since it is difficult and expensive to make these structures gas-tight, and considering the fact that gas production is highest in the first part of the reactor, it may be reasonable to collect gas from the first chambers only. These chambers must be completely gas-tight; rear chambers must be ventilated separately.

Tent systems (Fig. 60.) are mostly used in case of anaerobic ponds. **Balloons** may be connected to any anaerobic tank reactor. Balloons and tent systems require the same material. These materials must be gas-tight, UV-resistant, flexible and strong. PVC is not suitable. The weakest points are the seams and more so the connections between the foil and the pipes. To secure gas tightness, foils of tent plants are fixed to the solid structure below the liquid level. Foil covering may also be fixed to frames floating on the wastewater. Balloons should be laid on a sand bedding or be hung on belts or girdles. It may be necessary to protect them against damage by rodents. The gas pres-

sure must be kept under control to fit the permissible stress of the material, especially at joints. The provision of a safety valve which functions as a water seal on gas pressure should solve this problem.

Balloon and tent systems, unless securely fenced and protected against stones or rubbish being thrown on them by children, are not suitable for domestic plants.

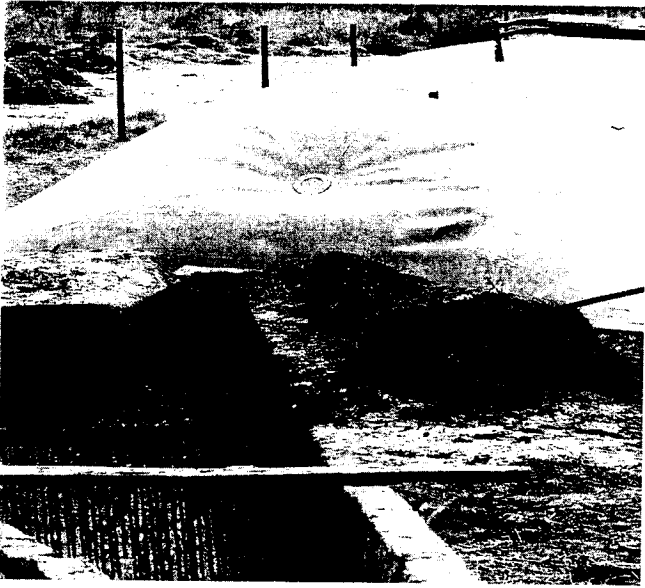

Fig. 60.

Tent gas storage above a liquid manure tank. Biogas plant constructed by SODEPRA and GTZ at a cattle park in Ferkessedougou / Ivory Coast. [photo: Sasse]

12.4 Distribution of Biogas

Normal water pipe installation technology may also be used for biogas distribution in DEWATS. However, ball valves should replace gate valves. All parts should be reasonably resistant against corrosion by sulphuric acid. Joints in galvanised steel pipes should be sealed with hemp and grease or with special sealing tape. Joints of PVC pipes must be glued; the glue must be spread around the total circumference of the pipe.

Biogas always contains a certain amount of water vapour, which condenses to water when gas cools down. This water must be drained; otherwise it may block the gas flow. Drain valves or automatic water traps to avoid blockage must be provided at the lowest point of each pipe sector. Pipes must be laid in continuous slope towards the drain points; straight horizontal pipes should not sag.

Gas pressure drops with growing length of pipe, and more so with smaller pipe diameter. Diameter of pipes must be larger when the point of consumption is far off. Long distances are generally not a problem. The distance should be kept as short as possible for economic reasons. Connecting stoves or lamps with a piece of flexible hose to the main distribution pipe has the advantage in that equipment can be moved without disconnecting the pipe. It also allows for condensed water to be drained.

In the case of fixed dome plants, a U-shaped gas pressure meter (manometer) could be installed near the point of consumption where it is difficult to see the amount of gas available.

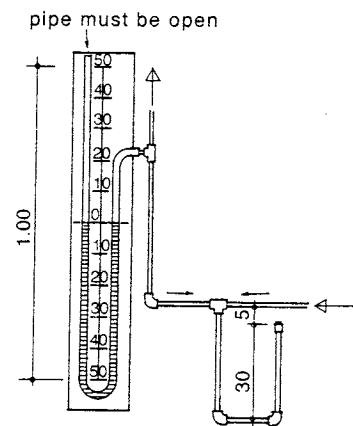

Fig. 61.

Pressure gauge out of transparent flexible pipes and water trap to collect condensed vapour which develops in gas pipes due to changing temperature. Water must be drawn from the trap when gas-flames start to flicker.

12.5 Gas Appliances

In principle, biogas can be used as any other gaseous fuel, for example in refrigerators, incubators, or water heaters. Nonetheless, use in stoves, lamps and diesel engines is most common.

Biogas needs a certain amount of air to burn - on an average one cubic meter of gas requires 5.7 m³ of air for complete combustion, one quarter of what LPG would need. Therefore, LPG burners have smaller jets; consequently the relative air intake compared to biogas burners is greater. The air intake that is needed for combustion is regulated by the difference of jet diameter to mixing pipe diameter. For open burners, which draw primary air at the jet and some secondary air at the flame port, the ratio between jet diameter and mixing pipe diameter may be taken as 1 : 6. For lamps, where secondary air supply is lower, this figure may be 1 : 8.

When converting LPG equipment to biogas, the jet must be widened, to say 1/6 of the diameter of the mixing pipe of a burner. These ratios are the same for all gas pressures. There is no need to regulate the air intake when gas pressure changes. However, air requirement is greater when methane content is higher. The difference is too small to be of practical importance. Since

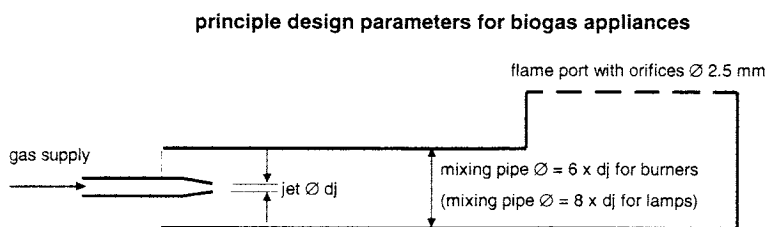

Fig. 62.

Design parameters for gas appliances. The relation between jet diameter and mixing pipe diameter is most important for performance and efficiency, irrespective of gas pressure. Other parameters are less crucial or can easier be found by trial and error, e.g. like number and diameter of orifices or length of mixing pipe.

flame speed of biogas is relatively low, biogas flames tend to be blown off when gas pressure is high. It may be advisable to increase the number or size of orifices at the flame port in order to reduce the speed. It is also possible to reduce the flow by placing an obstacle at the flame outlet; for example, a pot set on the burner.

It is trickier to regulate the air - gas mixture in lamps that use textile mantles, because the hottest part of the flame must be directly at the mantle in order to cause the mineral particles to glow. If the flame burns inside the mantle, the pressure might be too low and the primary air may be too much. If on the other hand, the flame burns outside the mantle, then primary air would be too little and the pressure might be too high. Since the composition of biogas also plays a role, general recommendations for lamp design are not easy to give. Practical testing is the only solution.

Diesel engines always have a surplus of air and proper mixing is not required. The gas is connected to the air supply pipe after the air filter. Mixing of air and gas is improved when gas enters the air pipe by cross flow. Dual fuel engines are started with 100% diesel; biogas is added slowly when the engine is hot and under load. The amount of biogas is regulated by hand according to experience. The engine usually starts to splutter when there is too much gas. When the engine runs smoothly, it is regulated like a pure diesel engine with the help of the throttle. For generating 1 kwh electricity, approximately 1.5 m³ biogas and 0.14 l diesel are required (GTZ).

13 COMPUTER SPREAD SHEETS

13.1 Technical Spread Sheets

13.1.1 Usefulness of Computer Calculation

The purpose of this chapter is to ensure that the engineer can produce his or her own spread sheet for sizing DEWATS in any computer programme that he or she is familiar with. The exercise of producing one's own tables will compel engineers to deepen their understanding of design.

The curves that have been used as the basis for calculation in the formulas applied in the computer spread sheets may also be of interest to those who may not use a computer (chapter 13.3 is addressed to them, especially). As these curves visualise the most important relations between various parameters, they will enhance understanding of the factors that influence the treatment process. It should be noticed that the graphs have been developed on the base of mixed information. Therefore, the ways of calculation follow not always the same logic.

Computerised calculations can be very helpful, particularly if the formulas and the input data are correct. On the other hand, what may look impressive may as well be 'rubbish in', 'rubbish out'. Nevertheless, assuming correct input data, the computer spread sheet gives a quick impression of the plant's space requirement and the treatment performance that can be expected. Ready-to-use computer spread sheets are especially helpful to those who do not design DEWATS on a daily basis and who would otherwise need to recol-

lect the entire theory for sizing a plant before starting to design.

13.1.2 Risks of Using Simplified Formulas

The formulas used in the spreadsheet have been constructed for use by practitioners who are less bothered by theoretical knowledge. Nevertheless, the formulas are based on scientific findings which had been simplified under consideration of practical experience.

Even if the formulas were to be 100% correct, the results would not be 100% accurate since the input data are not fully reliable. The accuracy of the formulas in general is likely to be greater than the accuracy of wastewater sampling and analysing. There are many unknown factors influencing treatment efficiency and any „scientific“ handbook would give a possible range of results. This book, howsoever „scientifically“ based, is made for practical people who have to build a real plant out of physically real and rigid building material. The supervisor cannot tell to the mason to make a concrete tank „about 4,90m to 5,60m long“, they have to say: „make it exactly 5,35 m“. The following spread sheets are of the same spirit. Anybody who uses more variable methods of calculation already, does not belong to the target group of this book and is free to modify formula and curves according to his or her experience and ability (the author would appreciate any information on improving the spread sheet).

Since the formulas represent simplifications of complex natural processes, there is a certain risk that they do not reflect the reality adequately. However, the risk of changes in the reality that is assumed is greater. For example, the expansion of a factory without enlarging the treatment system is obviously of greater influence than an assumed BOD of 350 mg/l, when in reality it is only 300 mg/l.

- ❑ In respect to using wrong figures for sludge accumulation in septic tanks, sedimentation ponds, Imhoff tanks and anaerobic reactors, the biggest risk is that shorter desludging intervals may become necessary.
- ❑ In case of anaerobic reactors, severe under-sizing could lead to a collapse of the process, while over-sizing may require longer maturation time at the beginning.
- ❑ Incorrect treatment performance of primary or secondary treatment steps could be the cause of over- or undersized post-treatment facilities. This would mean unnecessarily high investment costs, or the necessity of enlarging the post treatment facilities.
- ❑ Undersized anaerobic ponds stink, but slightly oversized ponds may not develop sufficient scum as a result of which these ponds stink as well.
- ❑ There is no harm in over-sizing aerobic ponds, bearing in mind that aerobic ponds, which are too small, may also smell badly.
- ❑ The biggest risk lies in clogging of filters, in both anaerobic tanks and gravel filters. However, the risk is more likely due to inferior filter material, faulty struc-

tural details or incorrect wastewater data than incorrect sizing.

In general, moderate over sizing reduces the risk of unstable processes and inferior treatment results.

13.1.3 About the Spread Sheets

The spreadsheets that are presented in this handbook are on EXCEL, version 5.0. Any other suitable programme may also be used. Please note that all calculations have been made on the German version of the computer programme. Therefore, decimal figures are expressed by a comma and Thousands are expressed by a point. For example 1.100,5 means „one thousand one hundred point five“.

There might be differences in the syntax of formulas, for example 3^2 (second power of 3) may be written =POWER(3;2) or =3^2, similar square root of 9 could be =SQRT(9) or =9^1/2, cubic root of 27 would be =power(27;1/3) or =27^1/3. Some programmes may accept only one of the alternatives.

The spreadsheets are based on data that is normally available to the planning engineer in the context of DEWATS. For example, while the measurement of the BOD₅ and the COD may be possible at the beginning of planning, it is unlikely that the BOD₅ will be regularly controlled later on. Therefore, calculations are based on COD or, the results of BOD-based formula have been set in relation to COD, and vice versa. The term BOD stands in the following for BOD₅.

Some of the formula used in the spreadsheets is based on curves, which had been obtained from scientific publications, handbooks and the author's and his colleagues

experience. The formulas basically define trends. For example, it is well known that the removal efficiency of an anaerobic reactor increases when the COD/BOD ratio is narrow. Such curves have been simplified to a chain of straight lines to allow the reader to easily understand the formulas and to adjust their values to local conditions if necessary. The number of data on which these curves are based are sometimes too insignificant to be of statistical relevance. However, they have been used and adjusted in accordance with practical experience.

The formulas are simple. Beside basic arithmetical operations, they use only one logical function, namely the „IF“-function. For example,

if temperature is less than 20°C; then hydraulic retention time is 20 days; if not, then it is 15 days
 in case the temperature is less than 25°C;
 otherwise (this means, if temperature is over 25°C) the HRT is 10 days.

Assuming the temperature is shown in cell F5 of the spread sheet, the formula is written in the cell for calculating the retention time as:

$$=IF(F5<20;20;IF(F5<25;15;10)).$$

The formula has been kept simple, so that the user may modify it according to experience or better knowledge. For example, it may be that with a certain substrate, the HRT should be 25 days at 20°C, 23 days at 25°C and 20 days above 25°C and for safety reasons, 10% longer retention time is added. Then the formula would read as:

$$=110%*IF(F5<20;25;if(F5<25;23;20)).$$

Values between the defined days may be calculated by using the famous “rule of three”, of which there are plenty examples in the tables that follow. The slope of a

straight line is expressed in its tangent and the height of a certain point is found by multiplying the length with the ratio of the slope, i.e. total height divided by total length (*Fig. 63.*).

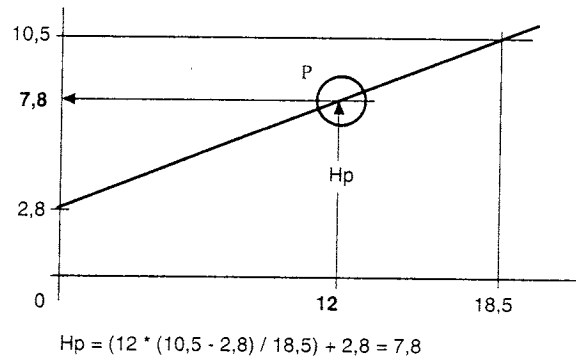

Fig. 63.

The graphical expression of the „rule of three“

In case the reader is not familiar with working in EXCEL, it would be better not to modify formulas but to manipulate the results by entering „modified“ data. For example, if values of spread sheet results are generally lower or higher than found by experience, dimensioning could be adjusted by entering lower or higher temperature values, or shorter or longer retention times. One could also multiply wastewater volumes or COD concentrations by a safety factor before starting the calculation. In any case all cells of the spread sheet should be locked, except the ones written in bold figures.

When the user prepares his or her own table the columns (A; B; C; D...) and the rows (1; 2; 3; 4; 5...) should not be written, because this would change the cell addresses of the formulas. Anyhow, cells and rows are shown on the mask of the monitor. When copying the formulas below, the cell name before the equals sign

should not be written. For example $E6=D5/E5$ is to be written in cell E6 as $=D5/E5$.

The *italic* figures are mostly guiding figures to show usual values, or they indicate limits to be observed. The **bold** figures are those which have to be filled in by hand, the other figures are calculated. Columns which are labelled „given“ contain data which reflect a given reality, for example, wastewater flow volume or wastewater strength. Columns which are labelled „chosen“ contain data which may be modified to optimise the design, for example hydraulic retention time or desludging intervals. All other cells contain formulas and should be locked, in order to avoid accidental deletion of formulas. Cells which are labelled „check“ or „require“ are to be observed whether the chosen and given values fit the chosen or calculated design.

13.1.4 Assumed COD / BOD Relation

The COD/BOD ratio widens during biological treatment because the BOD reflects only that part which consumes oxygen in a biological process while the COD represents all oxygen consumers. The removed BOD is percentage-wise a smaller portion of the COD than it is of the BOD. The COD/BOD ratio widens more when biological degradation is incomplete, and is less wide when treatment efficiency reaches almost 100%.

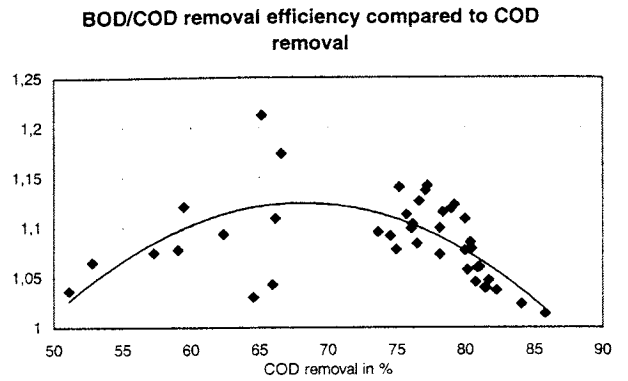

Fig. 64. Change of COD/BOD ratio during anaerobic treatment. The samples have been taken by SIITRAT from anaerobic filters, most of them serving schools in the suburbs of Delhi / India.

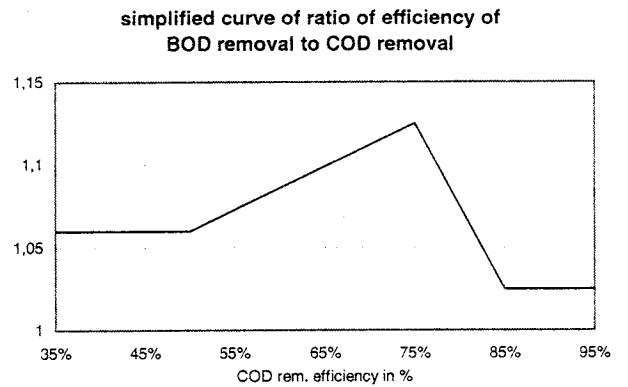

Fig. 65. Simplified curve of Fig. 64. which is used in the spread sheet formulas.

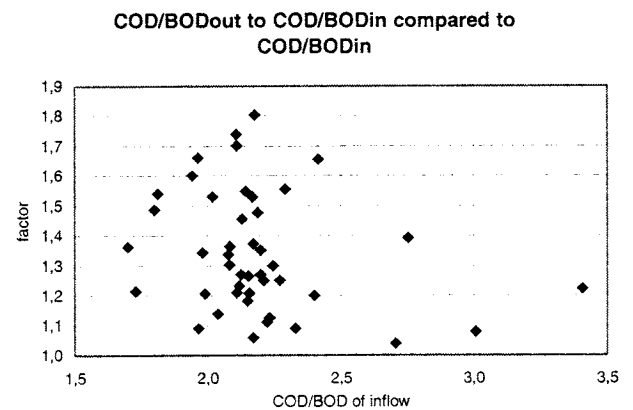

Fig. 66. Changes of COD/BOD ratio during anaerobic treatment of domestic wastewater. The samples have been taken by SIITRAT. The few sample points of high COD/BOD ratio (to the right of the graph) stem from a post-treatment plant and are not really comparable to the majority of samples.

13.1.5 Wastewater Production per Capita

The spread sheet (*Tab. 22.*) helps to define domestic wastewater on the basis of the number of persons and the wastewater they discharge. BOD and water consumption figures vary widely from place to place, and therefore should be inquired very carefully.

Formulas used on the spread sheet „waste-water per capita“

$$E5=A5*C5/1000$$

$$F5=A5*B5/E5$$

$$G5=D5*F5$$

Tab. 22. Spread sheet for calculation of wastewater per capita

	A	B	C	D	E	F	G
1	Wastewater production per capita						
2	user	BOD ₅ per user	water consump. per user	COD / BOD ₅ ratio	daily flow of wastewater	BOD ₅ concentr.	COD concentr.
3	given	given	given	given	calcul.	calculated	approx.
4	number	g/day	litres/day	mg/l / mg/l	m ³ /day	mg/l	mg/l
5	80	55	165	1,90	13,20	333	633
6	range =>	40 - 65	50-300				

13.1.6 Septic Tank

The size of septic tanks is standardised in most countries. However, in case of DEWATS the wastewater that is used may not be the normal domestic wastewater. The spread sheet (*Tab. 23.*) will help to design the septic tank accordingly.

Volume, number of peak hours of flow and pollution load are the basic entries. Starting from these data the "entrance parameters" are the desludging interval and the HRT because the former decides the digester volume to store the accumulating sludge and the later, because it decides on the volume of the liquid.

To observe the fact that sludge compacts with time, the formulas in the spread sheets are based on graph *Fig. 67.*

COD removal rates in settlers and septic tanks depend to a great deal on the amount of settleable solids, their COD content and the intensity of inoculation of fresh inflow.

The contact between fresh incoming substrate and active sludge in Imhoff tanks is nearly zero, while in sedimentation ponds with a deep inlet, it is intensive. This fact has been taken into the formula by dividing the parameter "settleable SS per COD" by an experienced factor of 0.50 - 0.60. The general tendency is shown in graph *Fig. 68.*

reduction of sludge volume during storage

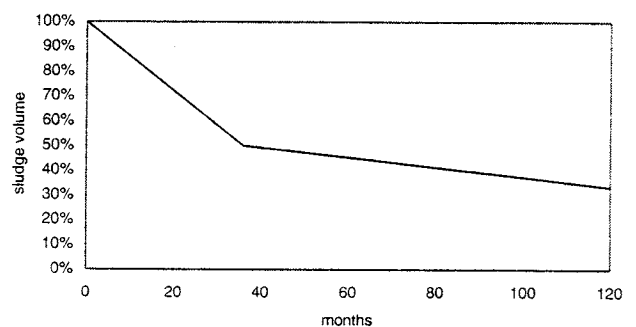

Fig. 67. Reduction of sludge volume during storage

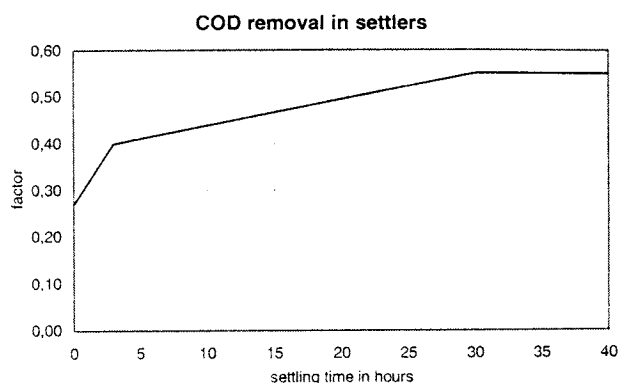

Fig. 68. COD removal in settlers

Formulas of spread sheet „septic tank“

$C5=A5/B5$

$H5=G5/0,6*IF(F5<1;F5*0,3;IF(F5<3;(F5-1)*0,1/2+0,3;IF(F5<30;(F5-3)*0,15/27+0,4;0,55)))$

The formula relates to Fig. 68. The number 0,6 is a factor found by experience.

$I5=(1-H5)*D5$

$J5=(1-H5*J6)*E5$

$E6=D5/E5$

$J6=IF(H5<0,5;1,06;IF(H5<0,75;(H5-0,5)*0,065/0,25+1,06;IF(H5<0,85;1,125-(H5-0,75)*0,1/0,1;1,025)))$

The formula relates to Fig. 65.

$D11=2/3*H11/B11/C11$

$F11=D11/2$

$H11=IF(H12*(E5-J5)/1000*A11*30*A5+C5*F5<2*A5*F5/24;2*A5*F5/24;H12*(E5-J5)/1000*A11*30*A5+C5*F5)+0,2*B11*E11$

The formula takes care that sludge volume is less than half the total volume.

$I11=(E11+G11)*C11*B11$

$J11=(D5-I5)*A5*0,35/1000/0,7*0,5$
350 l methane is produced from each kg COD removed.

$H12=0,005*IF(A11<36;1-A11*0,014;IF(A11<120;0,5-(A11-36)*0,002;1/3))$

The formula relates to Fig. 67.

Tab. 23. Spread sheet for calculation of septic tank dimensions

	A	B	C	D	E	F	G	H	I	J	
1	General spread sheet for septic tank, input and treatment data										
2	daily waste water flow	time of most waste water flow	max flow at peak hours	COD inflow	BOD ₅ inflow	HRT inside tank	settleable SS / COD ratio	COD removal rate	COD outflow	BOD ₅ outflow	
3	given	given	calcul.	given	given	chosen	given	calcul.	calcul.	calcul.	
4	m ³ /day	h	m ³ /h	mg/l	mg/l	h	mg/l / mg/l	%	mg/l	mg/l	
5	13,0	12	1,08	633	333	18	0,42	35%	411	209	
6	COD/BOD ₅ ->				1,90	12 - 24 h	0,35-0,45 domestic		BODrem.->	1,06	
7	dimensions of septic tank										
8	de-sludging interval	inner width of septic tank	minimum water depth at outlet point	inner length of first chamber		length of second chamber		volume incl. sludge	actual volume of septic tank	biogas 70%CH ₄ ; 50% dissolved	
9	chosen	chosen	chosen	requir.	chosen	requir.	chosen	requir.	check	calcul.	
10	months	m	m	m	m	m	m	m ³	m ³	m ³ /d	
11	12	2,50	2,00	3,13	3,10	1,56	1,55	23,46	23,25	0,72	
12	sludge /g BODrem.								0,0042		

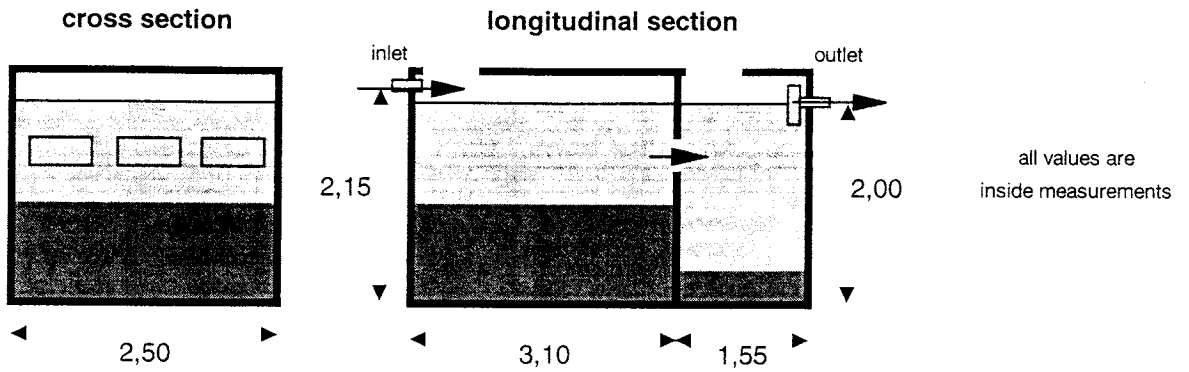

Fig. 69.
Illustration to spread sheet for calculation of septic tank dimensions

Imhoff Tank

Except for the fact that sedimentation is more effective in the Imhoff tank, the other treatment properties are comparable to that of any settler. However, if wastewater has to remain „fresh,“ it cannot at the same time, come into close contact with active sludge. Therefore, BOD removal from the liquid is close to zero. Because sedimentation is more, the COD or BOD removal is comparable and only reflected in the factor 0.50 of cell H5.

Volume, number of peak hours of flow and pollution load are the basic entries. Starting from these data, the “entrance parameters” are - similar to that of the septic tank - HRT and desludging intervals.

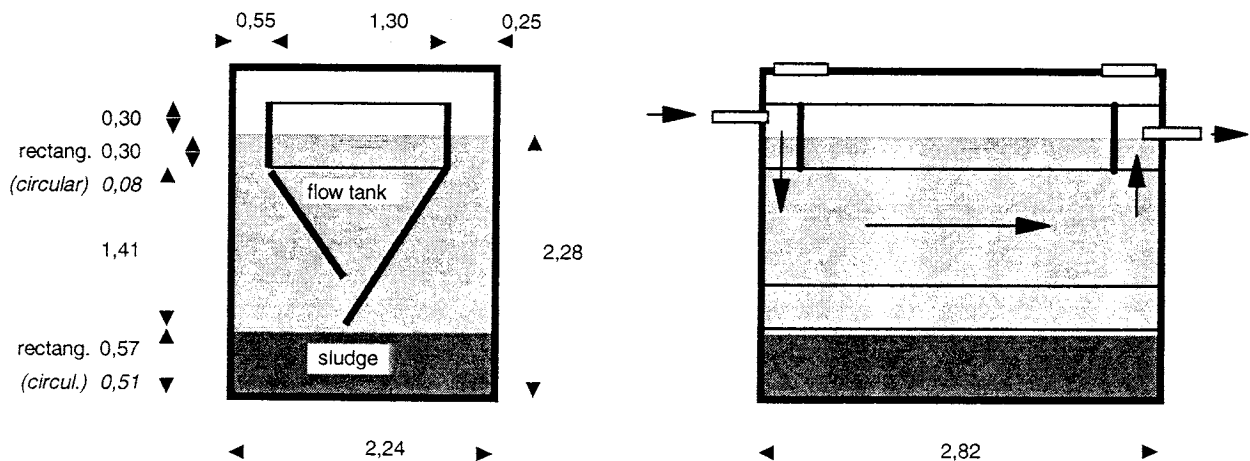

Fig. 70.
Illustration to spread sheet for calculation of Imhoff Tank dimensions

Tab. 24.

Spread sheet for calculation of Imhoff Tank dimensions

	A	B	C	D	E	F	G	H	I	J
1	General spread sheet for Imhoff tank, input and treatment data									
2	daily waste water flow	time of most waste water flow	max flow at peak hours	COD inflow	BOD ₅ inflow	HRT inside flow tank	settleable SS / COD ratio	COD removal rate	COD outflow	BOD ₅ outflow
3	given	given	calcul.	given	given	chosen	given	calcul.	calcul.	calcul.
4	m ³ /day	h	m ³ /h	mg/l	mg/l	h	mg/l / mg/l	%	mg/l	mg/l
5	25,00	12	2,08	633	333	1,50	0,42	27%	460	237
6	COD/BOD ₅ ->				1,90	domestic: 0,35-0,45			COD/BODrem	1,06
7	dimensions of Imhoff tank									
8	de-sludging interval	flow tank volume	sludge volume	inner width of flow tank	space beside flow tank	total inner width of Imhoff tank	inner length of Imhoff tank	sludge height	total depth at outlet	biogas 70%CH ₄ ; 50% dissolved
9	chosen	calcul.	calcul.	chosen	chosen	calcul.	calcul.	calcul.	calcul.	calcul.
10	months	m ³	m ³	m	m	m	m	m	m	m ³ /d
11	12	3,13	3,61	1,30	0,55	2,24	2,82	0,57	2,28	1,08
12	sludge /g BODrem.		0,0042							

Formulas of spread sheet „Imhoff Tank“

$$C5=A5/B5$$

$$H5=G5/0,5*IF(F5<1;F5*0,3;IF(F5<3;(F5-1)*0,1/2+0,3;IF(F5<30;(F5-3)*0,15/27+0,4;0,55)))$$

The formula relates to Fig. 68. The number 0,5 is a factor found by experience.

$$I5=(1-H5)*D5$$

$$J5=(1-H5*J6)*E5$$

$$E6=D5/E5$$

$$J6=IF(H5<0,5;1,06;IF(H5<0,75;(H5-0,5)*0,065/0,25+1,06;IF(H5<0,85;1,125-(H5-0,75)*0,1/0,1;1,025)))$$

The formula relates to Fig. 65.

$$B11=C5*F5$$

$$C11=A5*30*A11*C12*(E5-J5)/1000$$

$$F11=D11+E11+0,25+2*0,07$$

All formulas of dimensions relate to the geometry of the Imhoff tank as shown in Fig. 70.

$$G11=B11/(0,3*D11+(D11*D11*0,85/2))$$

$$H11=C11/F11/G11$$

$$I11=H11+0,85*D11+0,3+0,3$$

$$J11=(D5-I5)*A5*0,35/1000/0,7*0,5$$

350 l methane is produced from each kg COD removed.

$$C12=0,005*IF(A11<36;1-$$

$$A11*0,014;IF(A11<120;0,5-(A11-36)*0,002;1/3))$$

The formula relates to Fig. 67.

13.1.8 Anaerobic Filters

Volume of flow and pollution load are the basic entries. Starting from that data the „entrance parameter“ for the anaerobic filter is the hydraulic retention time. The performance of anaerobic filters is based on the curve which shows the relation between hydraulic retention time and percent of COD removal. The curve (Fig. 71.) is based on COD 1500 mg/l and 25°C. Their values are further multiplied by factors reflecting temperature (Fig. 72.), wastewater strength (Fig. 73.) and specific filter surface (Fig. 74.).

The void space of filter medium influences the digester volume which is required to provide sufficient hydraulic retention time. Gravel has approximately 35% void space while special plastic form pieces may have over 90%. When filter height increases with total water depth, consequently, the impact of increased depth on HRT is less with gravel than with plastic form pieces. When filter height shall remain the same, the distance from filter bottom to digester floor must be increased.

anaerobic filter, CODrem in relation to HRT, COD in 1500 mg/l; 25°C

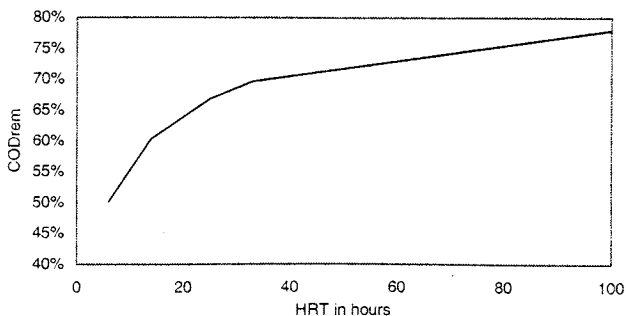

Fig. 71. COD removal relative to HRT in anaerobic filters

anaerobic reactors, CODrem relative to temperature

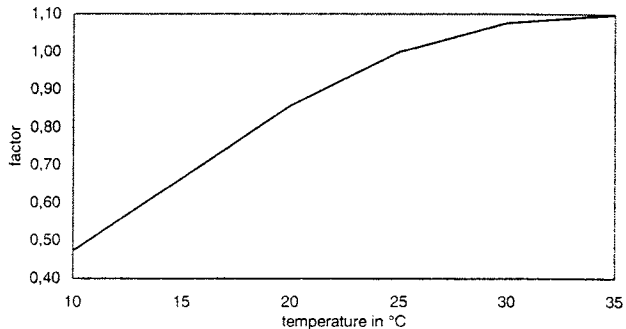

Fig. 72. COD removal relative to temperature in anaerobic reactors

anaerobic filter, CODrem in relation to wastewater strength

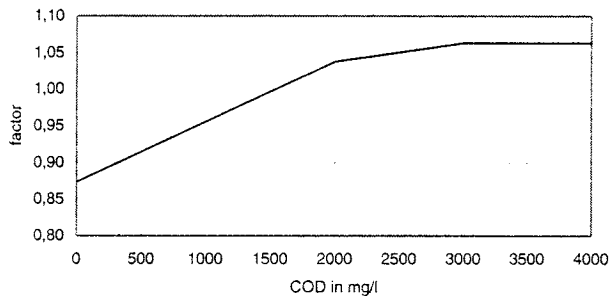

Fig. 73. COD removal relative to wastewater strength in anaerobic filters

anaerobic filter, CODrem in relation to specific filter surface

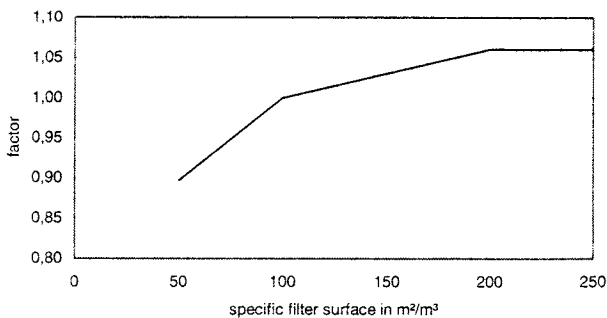

Fig. 74. COD removal relative to filter surface in anaerobic filters

Tab. 25.
Spread sheet for calculation of anaerobic filter dimensions

General spread sheet for anaerobic filter (AF) with integrated septic tank (ST)														
1	A	B	C	D	E	F	G	H	I	J	K	L		
2	daily waste water flow	time of most waste water flow	max. peak flow per hour	COD inflow	BOD ₅ inflow	SS _{sett.} / COD ratio	lowest digester temper.	HRT in septic tank	de-sludging interval	COD removal septic tank	BOD ₅ removal septic tank	BOD / COD remov. factor		
3	given	given	calcul.	given	given	given	given	chosen	chosen	calcul.	calcul.	calcul.		
4	m ³ /day	h	m ³ /h	mg/l	mg/l	mg/l / mg/l	°C	h	months	%	%	ratio		
5	25,00	12	2,08	633	333	0,42	25	2	36	25%	26%	1,06		
6	COD/BOD ₅ ->			1,90	0,35-0,45 (domestic)			2h						
7	treatment data													
8	COD inflow in AF	BOD ₅ inflow into AF	specific surface of filter medium	voids in filter mass	HRT inside AF reactor	factors to calculate COD removal rate of anaerobic filter				COD removal rate (AF only)	COD outflow of AF	COD rem rate of total system		
9	calcul.	calcul.	given	given	chosen	calculated according to graphs						calcul.	calcul.	calcul.
10	mg/l	mg/l	m ² /m ³	%	h	f-temp	f-streight	f-surface	f-HRT	%	mg/l	%		
11	478	247	100	35%	30	1,00	0,91	1,00	69%	70%	142	78%		
12	80 - 120			30-45	24 - 48 h									
13	dimensions of septic tank													
14	BOD / COD rem. factor	BOD ₅ rem rate of total system	BOD ₅ outflow of AF	inner width of septic tank	minimum water depth at inlet point	inner length of first chamber		length of second chamber		sludge accum.	Volume incl. sludge	actual volume of septic tank		
15	calcul.	calcul.	calcul.	chosen	chosen	calcul.	chosen	calcul.	chosen	calc.	requir.	calcul.		
16	ratio	%	mg/l	m	m	m	m	m	m	l/kg BOD	m ³	m ³		
17	1,10	85%	49	1,75	2,25	1,69	1,70	0,85	0,85	0,00	10,00	10,04		
18	sludge Vg BODrem.													
19	dimension of anaerobic filter							biogas production			check !			
20	volume of filter tanks	depth of filter tanks	length of each tank	number of filter tanks	width of filter tanks	space below perforated slabs	filter height (top 40 cm below water level)	out of septic tank	out of anaerobic filter	total	org.load on filter volume COD	maximum up-flow velocity inside filter voids		
21	calcul.	chosen	calcul.	chosen	requir.	chosen	calcul.	assump: 70%CH ₄ ; 50% dissolved			calcul.	calcul.		
22	m ³	m	m	No.	m	m	m	m ³ /d	m ³ /d	m ³ /d	kg/m ³ *d	m/h		
23	31,25	2,25	2,25	3	2,69	0,60	1,20	0,97	2,10	3,07	1,57	0,98		
24	max!!													

Formulas of spread sheet „anaerobic filter“

$$C5=A5/B5$$

$$J5=F5/0,6*IF(H5<1;H5*0,3;IF(H5<3;(H5-1)*0,1/2+0,3;IF(H5<30;(H5-3)*0,15/27+0,4;0,55)))$$

The formula relates to Fig. 68. The number 0,6 is a factor found by experience.

$$K5=L5*J5$$

$$L5=IF(J5<0,5;1,06;IF(J5<0,75;(J5-0,5)*0,065/0,25+1,06;IF(J5<0,85;1,125-(J5-0,75)*0,1/0,1;1,025)))$$

The formula relates to Fig. 65.

$$D6=D5/E5$$

$$A11=D5*(1-J5)$$

$$B11=E5*(1-K5)$$

$$F11=IF(G5<20;(G5-10)*0,39/20+0,47;IF(G5<25;(G5-20)*0,14/5+0,86;IF(G5<30;(G5-25)*0,08/5+1;1,1)))$$

The formula relates to Fig. 72.

$$G11=IF(A11<2000;A11*0,17/2000+0,87;IF(A11<3000;(A11-2000)*0,02/1000+1,04;1,06))$$

The formula relates to Fig. 73.

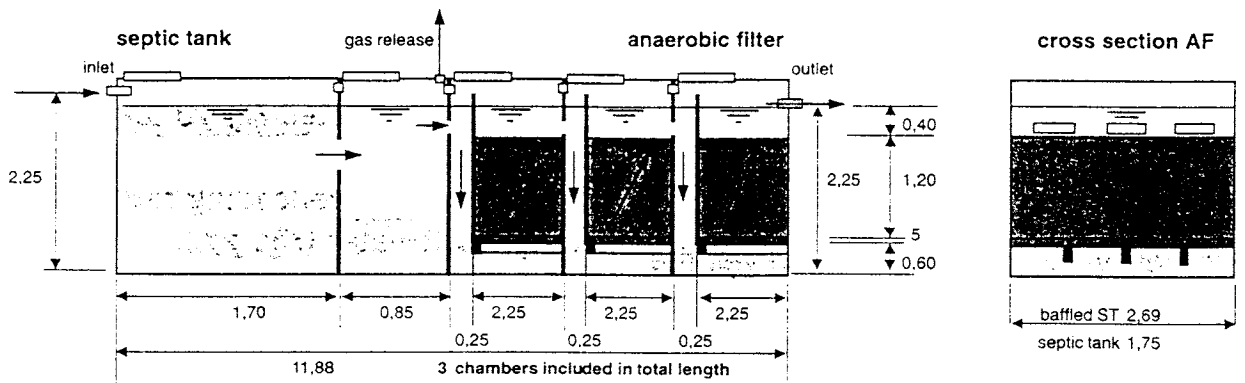

Fig. 75.

Illustration to spread sheet for calculation of anaerobic filter dimensions

H11=IF(C11<100;(C11-50)*0,1/50+0,9;IF(C11<200;(C11-100)*0,06/100+1;1,06))

The formula relates to Fig. 74.

I11=IF(E11<12;E11*0,1612+0,44;IF(E11<24;(E11-12)*0,07/12+0,6;IF(E11<33;(E11-24)*0,03/9+0,67;IF(E11<100;(E11-33)*0,09/67+0,7;0,78))))

The formula relates to Fig. 71.

J11=IF(F11*G11*H11*I11*(1+(D23*0,04))<0,98;F11*G11*H11*I11*(1+(D23*0,04));0,98)

The formula considers improved treatment by increasing the number of chambers and limits the treatment efficiency to 98%

K11=A11*(1-J11)

L11=(1-K11/D5)

A17=IF(L11<0,5;1,06;IF(L11<0,75;(L11-0,5)*0,065/0,25+1,06;IF(L11<0,85;1,125-(L11-0,75)*0,1/0,1;1,025)))

The formula relates to Fig. 65.

B17=L11*A17

C17=(1-B17)*E5

F17=2/3*K17/D17/E17

H17=F17/2

J17=0,005*IF(I5<36;1-I5*0,014;IF(I5<120;0,5-(I5-36)*0,002;1/3))

The formula relates to Fig. 67.

K17=IF(OR(K5>0;J5>0);IF(J17*(E5-B11)/1000*15*30*A5+H5*C5<2*H5*C5;J17*(E5-B11)/1000*15*30*A5+H5*C5);0)

The formula controls that sludge volume is less than half the total volume and allows to omit any settler.

L17=(G17+I17)*E17*D17

A23=E11*A5/24

C23=B23

E23=A23/D23/((B23*0,25)+(C23*(B23-G23*(1-D11))))

G23=B23-F23-0,4-0,05

H23=(D5-A11)*A5*0,35/1000/0,7*0,5
350 l methane is produced from each kg COD removed.

I23=(A11-K11)*A5*0,35/1000/0,7*0,5
350 l methane is produced from each kg COD removed.

J23=SUM(H23:I23)

K23=A11*A5/1000/(G23*E23*C23*D11*D23)

L23=C5/(E23*C23*D11)

13.1.9 Baffled Septic Tank

Volume, number of peak hours of flow and pollution load are the basic entries. Starting from these data, the "entrance parameter" for designing a baffled septic tank is the up-flow velocity (cell I17). However, the performance of the baffled septic tank depends as well on the retention time which cannot be reduced by simply changing the depth of the up-flow chambers, because up-flow velocity will then increase. To achieve the desired effluent quality, it is better to add another chamber because treatment efficiency increases with number of chambers (see formula of cell H11). The influence of temperature is less severe than with other anaerobic tanks. Too weak

wastewater does not produce enough sludge for intensive contact of bacteria and incoming wastewater. **Fig 78** takes care of this effect. An additional curve is used to prevent organic overloading caused by too strong wastewater (**Fig. 77**).

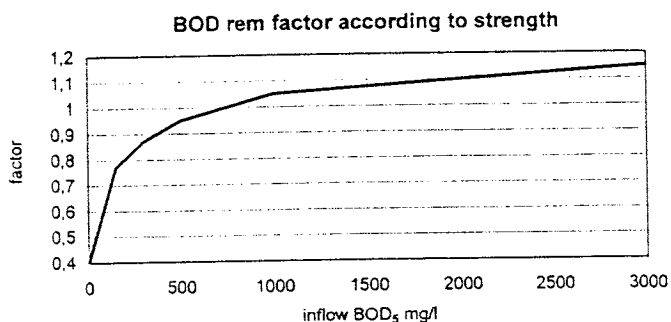

Fig. 78. BOD removal in baffled septic tanks related to wastewater strength

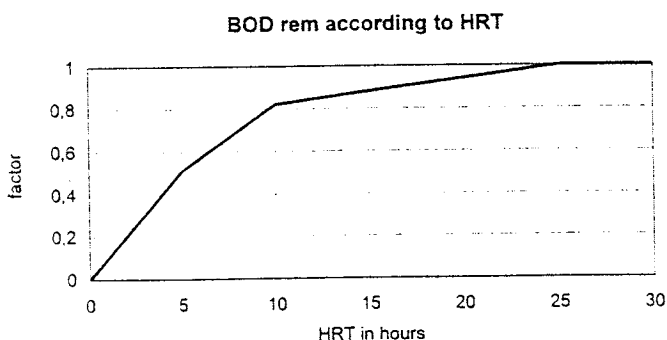

Fig. 76. BOD removal relative to HRT in baffled septic tanks

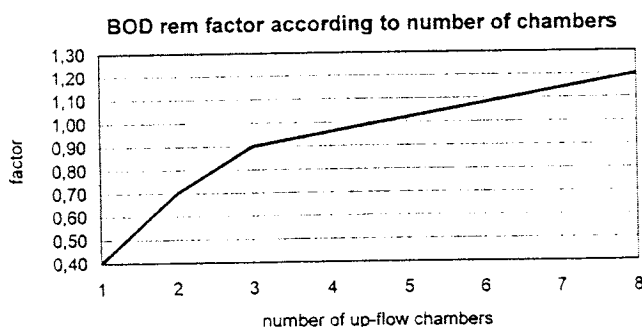

Fig. 78a. Influence of number of upflow chambers on BOD removal rate

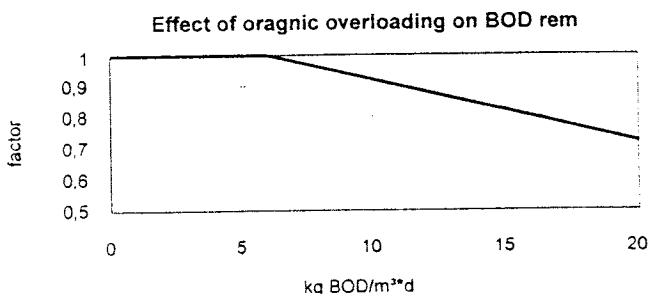

Fig. 77. BOD removal affected by organic overloading in baffled septic tanks

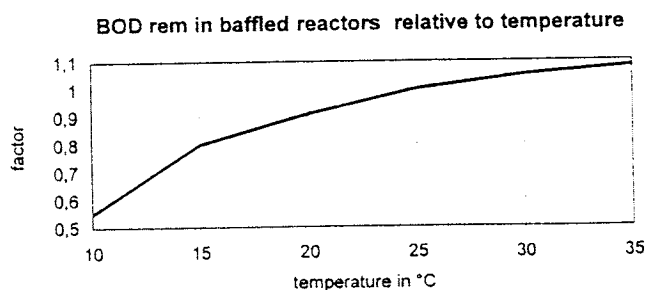

Fig. 78b. Influence of temperature on BOD removal rates in baffled septic tanks

Tab. 26.
Spread sheet for calculation of baffled septic tank dimensions

	A	B	C	D	E	F	G	H	I	J	K
1	General spread sheet for baffled septic tank with integrated settler										
2	daily waste water flow	time of most waste water flow	max peak flow per hour	COD inflow	BOD ₅ inflow	COD/BOD ratio	settleable SS / COD ratio	lowest digester temp.	de-sludging interval	HRT in settler (no settler HRT = 0)	COD removal rate in settler
3	avg.	given	max	given	given	calcul.	given	given	chosen	chosen	calcul.
4	m ³ /day	h	m ³ /h	mg/l	mg/l	ratio	mg/l / mg/l	°C	months	h	%
5	25,00	12	2,08	633	333	1,90	0,42	25	18	1,50	23%
6	0,35-0,45										1,5 h
7	treatment data										
8	BOD ₅ removal rate in settler	inflow into baffled reactor		COD / BOD ₅ ratio after settler	factors to calculate BOD removal rate of baffled reactor					theor. rem rate calcul. by factors	BOD out
9	calcul.	COD	BOD ₅	calcul.	calculated according to graphs					72%	calcul.
10	%	mg/l	mg/l	mg/l/mg/l	f-overload	f-strength	f-temp	f-chamb.	f-HRT	applied	mg/l
11	24%	489	253	1,94	1,00	0,84	1,00	1,02	0,84	72%	70
12	1,06	←COD / BOD rem.factor							COD / BOD removal factor→		1,085
13	dimensions of settler						baffled septic tank				
14	total BOD ₅ rem.rate	total COD rem.rate	COD out	inner masonry measurements chosen acc. to required volume		sludge accum. rate	length of settler	length of settler	max upflow velocity	number of upflow chambers	depth at outlet
15	calcul.	calcul.	calcul.	width	depth	calcul.	calcul.	chosen	chosen	chosen	chosen
16	%	%	mg/l	m	m	l/g COD	m	m	m/h	No.	m
17	79%	73%	172	2,00	1,50	0,0037	2,39	2,40	1,8	5	1,50
18	1,4-2.0 m/h										
19	dimensions of baffled septic tank							status and gp			
20	length of chambers should not exceed half depth		area of single upflow chamber	width of chambers		actual upflow velocity	width of downflow shaft	actual volume of baffled reactor	HRT in baffled tank	org. load (BOD ₅)	biogas (ass: CH ₄ 70%; 50% dissolved)
21	calcul.	chosen	calcul.	calcul.	chosen	calcul.	chosen	calcul.	calcul.	calcul.	calcul.
22	m	m	m ²	m	m	m/h	m	m ³	h	kg/m ³ *d	m ³ /d
23	0,75	0,75	1,16	1,54	2,00	1,39	0,25	15,00	14	0,84	3,52
24	HRT reduced by 5% for sludge										

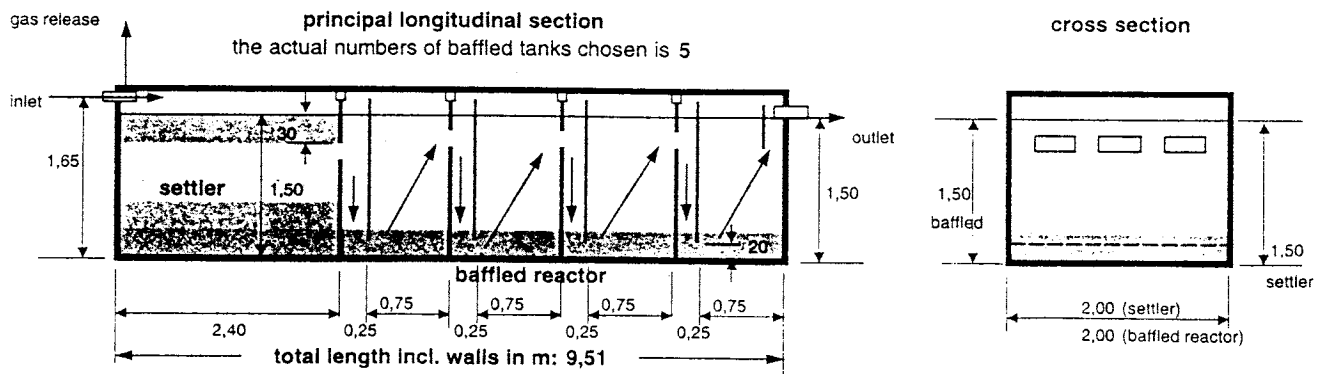

Fig. 79.
Illustration to spread sheet for calculation of baffled septic tank dimensions

Formulas of spread sheet "baffled septic tank"

$$C5=A5/B5$$

$$F5=D5/E5$$

$$K5=G5/0,6*IF(J5<1;J5*0,3;IF(J5<3;(J5-1)*0,1/2+0,3;IF(J5<30;(J5-3)*0,15/27+0,4;0,55)))$$

The formula relates to Fig. 68. The number 0,6 is a factor found by experience.

$$A11=K5*A12$$

$$B11=D5*(1-K5)$$

$$C11=E5*(1-A11)$$

$$D11=B11/C11$$

$$E11=IF(J23<6;1;1-(J23-6)*0,28/14)$$

The formula relates to Fig. 77.

$$F11=IF(C11<150;C11*0,37150+0,4;IF(C11<300;(C11-150)*0,1/150+0,77;IF(C11<500;(C11-300)*0,08/200+0,87;IF(C11<1000;(C11-500)*0,1/500+0,95;IF(C11<3000;(C11-1000)*0,1/2000+1,05;1,15))))))$$

The formula relates to Fig. 78.

$$G11=IF(H5<15;(H5-10)*0,25/5+0,55;IF(H5<20;(H5-15)*0,11/5+0,8;IF(H5<25;(H5-20)*0,09/5+0,91;IF(H5<30;(H5-25)*0,05/5+1;(H5-30)*0,03/5+1,05))))))$$

The formula relates to Fig. 78 b.

$$H11=IF(J17=1;0,4;IF(J17=24;0,7;IF(J17=3;0,9;(J17-3)*0,06+0,9)))$$

The formula relates to Fig. 78a.

$$I11=IF(I23<5;I23*0,51/5;IF(I23<10;(I23-5)*0,31/5+0,51;IF(I23<25;(I23-12)*0,18/15+0,82;1)))$$

The formula relates to Fig. 76.

$$J9=E11*F11*G11*H11*I11$$

$$J11=WENN(J9<0,8;J9;WENN(J9*(1-0,37*((J9)-0,8))<0,95;J9*(1-0,37*((J9)-0,8));0,95))$$

The formula limits unrealistic BOD removal rates

$$K11=(1-J11)*C11$$

$$A12=IF(K5<0,5;1,06;IF(K5<0,75;(K5-0,5)*0,065/0,25+1,06;IF(K5<0,85;1,125-(K5-0,75)*0,1/0,1;1,025)))$$

The formula relates to Fig. 65.

$$K12=IF(A17<0,5;1,06;IF(A17<0,75;(A17-0,5)*0,065/0,25+1,06;IF(A17<0,85;1,125-(A17-0,75)*0,1/0,1;1,025)))$$

The formula relates to Fig. 65.

$$A17=1-K11/E5$$

$$B17=A17/K12$$

$$C17=(1-B17)*D5$$

$$F17=0,005*IF(I5<36;1-I5*0,014;IF(I5<120;0,5-(I5-36)*0,002;1/3))$$

The formula relates to Fig. 67.

$$G17=IF(A11>0;IF(F17*(E5-C11)/1000*30*I5*A5+J5*C5<2*J5*C5;F17*(E5-C11)/1000*30*I5*A5+J5*C5);0)/D17/E17$$

The formula takes care that sludge volume is less than half the total volume, settler may be omitted

$$A23=K17*0,5$$

$$C23=C5/I17$$

$$D23=C23/B23$$

$$F23=C5/B23/E23$$

$$H23=(G23+B23)*J17*K17*E23$$

$$I23=H23/(A5/24)/105\%$$

$$J23=C11*C5*24/H23/1000$$

$$K23=(D5-K11)*A5*0,35/1000/0,7*0,5$$

350 l methane is produced from each kg COD removed

3.1.10 Biogas Plant

The biogas plant as it is known in rural households of India functions more or less as a fully mixed reactor, where cattle dung is thoroughly mixed by hand with water. The substrate, even as effluent is very viscous, little sludge settles as a result and for many years no sludge is removed at all. The same rural biogas plant in China receives a substrate which is a mixture of human excreta, pigs dung and water, however by far not as homogeneous as commonly found in India. Other wastewater, for

example from slaughter houses may have again different properties. It is therefore difficult to find dimensions for all kind of „strong“ wastewater for which a biogas plant could be suitable. The following spread sheet should be used with certain reservation and formulas may need to be adapted locally.

The spread sheet, however, reveals the influencing factors. The formulas are based on the following assumptions:

- ❑ Solids which settle within one day of bench scale testing represent 95% of all settleable solids.
- ❑ There is a mixing effect inside the digester due to relatively high gas production which does not allow additional sludge to settle. Any additional sludge will only make good for the loss in volume by compression. Thus, the accumulating sludge volume is the same vol-

ume which is calculated from the one day of bench scale testing.

- ❑ All settleable and non-settleable solids will digest within hydraulic retention times typical for sludge reactors
- ❑ 95% of their BOD is removed after 25 days and 30°C, this is equivalent to 400 l of biogas produced from 1 kg of organic dry matter

gas production in relation to HRT

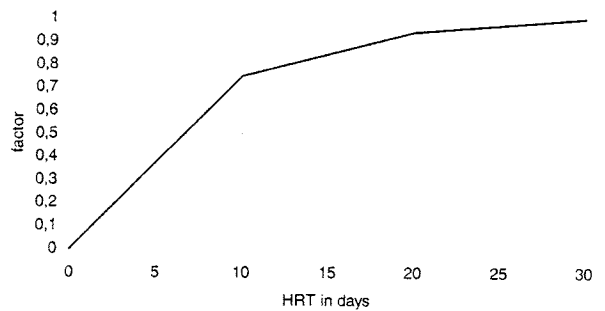

Fig. 80. Gas production of fixed dome biogas plants in relation to HRT

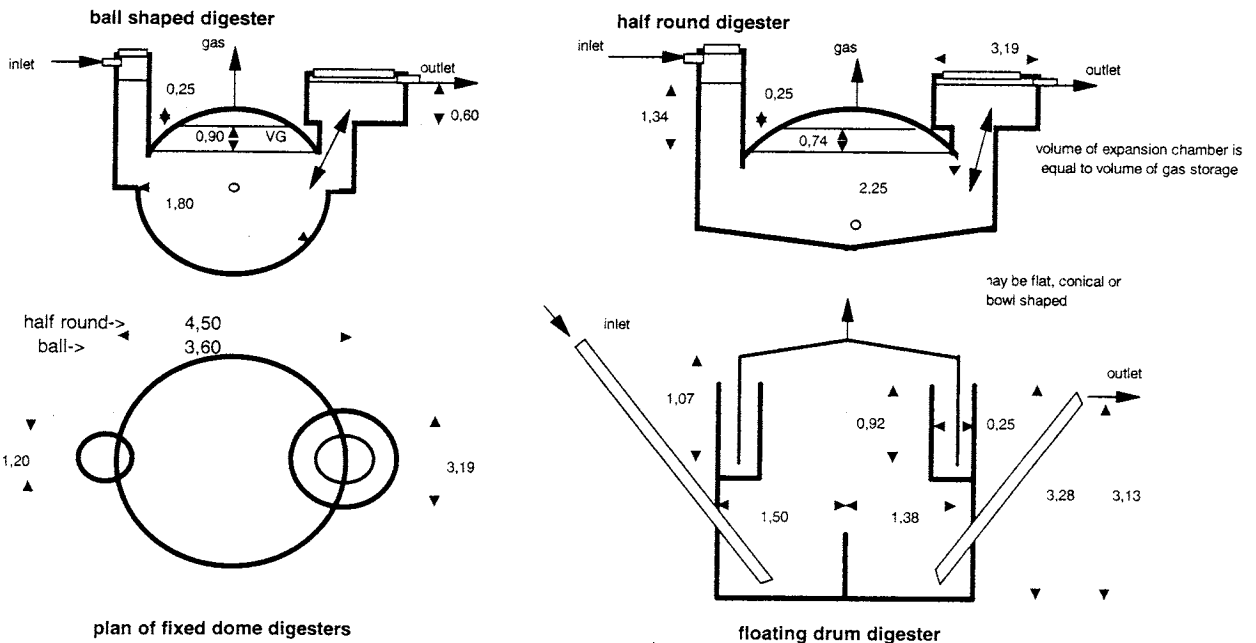

Fig. 82. Illustration to spread sheet for calculation of biogas plant dimensions

Tab. 27.
Spread sheet for calculation of biogas plant dimensions

	A	B	C	D	E	F	G	H	I	J	K	L
1	General spread sheet for biogas plants, input and gas production data											
	daily flow	TS (DM) content	org. DM / total DM	org. DM content	solids settleable within one day	HRT	lowest digester temper.	ideal biogas product. at 30°C	gas production factors		total gas product.	methan content
2	given	given	assumed	calcul.	tested	chosen	given	given	calcul. acc. to graphs		calcul.	assumed
3	m ³ /d	%	ratio	%	ml/l	d	°C	l/kg org DM	f-HRT	f-temp	m ³ /d	ratio
4	0,60	6,0%	67%	4,0%	20	25	25	400	0,97	0,90	8,42	70%
5	200-450											
6	values for all digester shapes						for all fixed dome plants					
	non-dissolv. methan prod.	approx. effluent COD	de-sludging interval	sludge volume	liquid volume	total digester volume	gas storage capacity	gas holder volume VG	free distance above slurry zero line	outlet above zero	diameter of left shaft	diameter of expans. chamber
8	assumed	calcul.	chosen	calcul.	calcul.	calcul.	given	calcul.	chosen	chosen	chosen	calcul.
9	ratio	mg/l	months	m ³	m ³	m ³	ratio	m ³	m	m	m	m
10	80%	7.943	12	4,32	15,0	19,3	65%	5,5	0,25	0,60	1,20	3,19
11	minimum 0,60 m											
12	cylindrical floating drum plant						ball shaped digester					
	radius of digester	width of water ring	wall thickness of water ring	radius of gas holder	theor. height of gas holder	theor. depths of digester	actual height of gas holder	actual depth of digester	volume of empty space above zero line	radius ball shape	actual digester radius (ball)	actual net volume of digester
14	chosen	chosen	chosen	calcul.	calcul.	calcul.	calcul.	calcul.	calcul.	requir.	chosen	check
15	m	m	m	m	m	m	m	m	m ³	m	m	m ³
16	1,50	0,25	0,12	1,38	0,92	3,13	1,07	3,28	0,34	1,77	1,80	20,56
17	ball shaped digester						half-ball shaped digester					
	lowest slurry level below zero line (fill in trial until "calcul." match "target")			gas pressure ball shaped	volume of empty space above zero line	radius half round shape	actual digester radius (half round)	actual net volume of digester	lowest slurry level below zero line (fill in trial until "calcul." match "target")			gas pressure half-ball
20	trial !!	calcul.	target	calc.	calcul.	requir.	chosen	check	trial !!	calcul.	target	calc.
21	m	m ³	m ³	m w.c.	m ³	m	m	m ³	m	m ³	m ³	m w.c.
22	0,90	5,89	5,81	1,50	0,43	2,23	2,25	20,01	0,74	5,91	5,90	1,34
23	1,50 max.											
24	1,50 max.											

gas production in relation to temperature

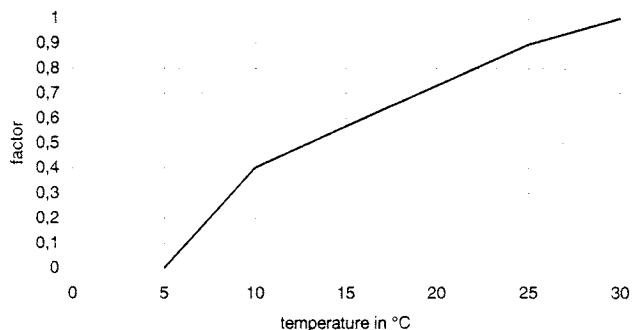

Fig. 81.
Gas production of fixed dome biogas plants in relation to temperature

Formulas of spread sheet „biogas plants“

$D5=B5*C5$

$I5=IF(F5<10;F5*0,75/10;IF(F5<20;(F5-10)*0,19/10+0,75;(F5-20)*0,06/10+0,94))$

The formula relates to Fig. 80

$J5=IF(G5<5;0;IF(G5<10;(G5-5)*0,4/5;IF(G5<25;(G5-10)*0,5/15+0,4;(G5-25)*0,1/5+0,9)))$

The formula relates to Fig. 81

$$K5=H5 \cdot I5 \cdot J5 \cdot A5 \cdot D5$$

$$B11=1,1 \cdot ((1000 \cdot K5 \cdot L5 / A11 / 0,35) / (0,95 \cdot I5 \cdot J5)) \cdot (1 - 0,95 \cdot I5 \cdot J5) / A5$$

The formula finds the influent COD and calculates the COD removal by assuming 350 l methane per kg COD removed; the additional 10% stand for the anorganic COD which is not removed.

$$D11=30 \cdot C11 \cdot A5 \cdot E5 / 1000$$

$$E11=F5 \cdot A5$$

$$F11=D11+E11$$

$$H11=K5 \cdot G11$$

$$L11=2 \cdot \text{SQRT}((H11/J11 - (K11/2) \cdot (K11/2) \cdot \text{PI}()) / \text{PI}())$$

The mathematical expression is:

$$2 \times \sqrt{\frac{\left(\frac{H11}{J11} - \left(\frac{K11}{2}\right)^2 \times \pi\right)}{\pi}}$$

$$D17=A17-B17/2$$

$$E17=H11 / (D17 \cdot D17 \cdot \text{PI}())$$

The mathematical expression is:

$$H11 / (D17^2 \times \pi)$$

$$F17=(F11 - \text{POWER}(A17-B17-C17;2) \cdot \text{PI}()) \cdot E17 / (A17 \cdot A17 \cdot \text{PI}()) + E17$$

The mathematical expression is:

$$F11 - \frac{(A17 - B17 - C17)^2 \times \pi \times E17}{A17^2 \times \pi} + E17$$

$$G17=E17+0,15$$

$$H17=F17+0,15$$

$$I17=3,14 \cdot I11 \cdot I11 \cdot (K17 - I11 / 3)$$

$$J17=0,02 + \text{POWER}((F11 + H11 / 2 + I17) / 4,19; 1/3)$$

The theoretical digester volume is taken as the volume below the zero line plus half the gas storage; 0,02 m are added for plaster. The mathematical expression is:

$$0,02 + \sqrt[3]{\frac{(F11 + H11 / 2 + I17)}{4,19}} ; 4,19 \text{ is } 4/3\pi$$

$$L17=4,19 \cdot (K17 - 0,02) \cdot (K17 - 0,02) \cdot (K17 - 0,02) - I17 - H11 / 2$$

$B23=\text{PI}() \cdot (I11+A23) \cdot (I11+A23) \cdot (K17 - (I11+A23) / 3)$
The volume above the lowest slurry level is found by trial and error; π is expressed as $\text{PI}()$.

$$C23=I17+H11$$

$$D23=A23+J11$$

$$E23=3,14 \cdot I11 \cdot I11 \cdot (G23 - I11 / 3)$$

$$F23=0,02 + \text{POWER}((F11 + H11 / 2 + E23) / 2,09; 1/3)$$

The mathematical expression is:

$$0,02 + \sqrt[3]{\frac{(F11 + H11 / 2 + E23)}{2,09}} ; 2,09 \text{ is } 2/3\pi$$

$$H23=2,09 \cdot (G23 - 0,02) \cdot (G23 - 0,02) \cdot (G23 - 0,02) - E23 - H11 / 2$$

$$J23=\text{PI}() \cdot (I23+I11) \cdot (I23+I11) \cdot (G23 - (I23+I11) / 3)$$

The volume above the lowest slurry level is found by trial and error; π is expressed as $\text{PI}()$.

$$K23=E23+H11$$

$$L23=I23+J11$$

13.1.11 Gravel Filter

Volume, number of flow and pollution load are the basic entries. Starting from these data, the „entrance parameter“ is the desired effluent quality (BOD_{out} , cell E_5). The hydraulic retention time and temperature have the greatest influence on treatment performance. The HRT depends on desired BOD removal rate (**Fig. 84.**). The curve is based on 25°C and 35% pore space. The pore space inside the filter defines the „real“ HRT, and the type of plantation plays also a certain role. However, more influencing factors may be near to 1.0 and, more importantly, the information needed to define these factors in any case, are most probably not available at site.

In practice, the limiting factors are the organic load and the hydraulic load. The limit for hydraulic load is approximately 100 l/m² (0.1 m *d). However, this value could be much higher when using coarse filter media with guaranteed conductivity. A horizontal filter should not receive more than 10 g BOD/m²*d, because oxygen supply via the surface is limited. This value of 10 g, com-

pared to 20 g for aerobic ponds are low. This is so because the gravel filter works more like a plug flow system, the organic load in the front part is much higher than in the rear part and oxygen supply is inferior in the lower part, also. This is the reason why cross section area at the inflow side is also related to organic loading (cell E12).

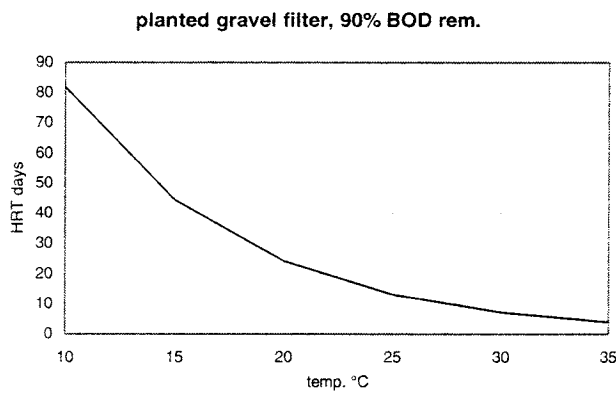

Fig. 83. HRT relative to temperature in gravel filters, based on 90% BOD removal

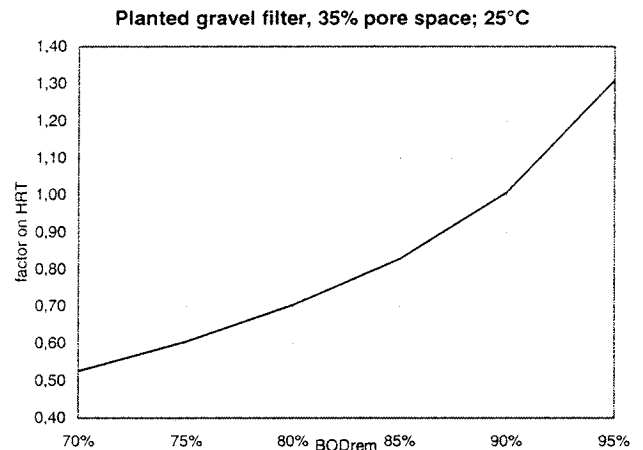

Fig. 84. Influence of desired BOD removal rates on HRT of gravel filters, based on 35% pore space at 25°C

Tab. 28. Spread sheet for calculation of dimensions of horizontal gravel filters

	A	B	C	D	E	F	G	H	I	J	K	L
1	General spread sheet for planted gravel filter, input and treatment data											
2	average flow	COD in	BOD ₅ in	COD/BOD ratio	outfl. BOD ₅	BOD ₅ rem. rate	COD rem.	COD out	min. annual Temp.	HRT factor acc. to k ₂₀ =0,3	HRT	hydraulic conduct. Ks
3	given	given	given	calcul.	wanted	calcul.	calcul.	calcul.	given	calcul.	calcul.	given
4	m ³ /d	mg/l	mg/l	mg/l / mg/l	mg/l	%	%	mg/l	C°	via graph	days	m/d
5	26	410	215	1,91	30	86%	84%	66	25	0,86	11,20	200
6	BOD rem.factor via graph->						1,025	Ks in m/s=>				2,31E-03
7	dimensions										results	
8	HRT in 35% pore space	bottom slope	depth of filter at inlet	cross section area	width of filter basin	surface area required	length of filter basin	chosen width	length chosen	actual surface area chosen	hydr. load on chosen surface	org. load on chosen surface
9	calcul.	chosen	chosen	calcul.	calcul.	calcul.	calcul.	chosen	chosen	check !	calcul.	calcul.
10	days	%	m	m ²	m	m ²	m	m	m	m ²	m/d	g/m ² BOD
11	3,92	1,0%	0,60	37,27	62,1	559	9,0	62,5	9,0	563	0,046	9,9
12	^information only		0,3-0,6 m	max BOD ₅	150	g/m ²	always >	62,1	max. loads=>		0,100	10

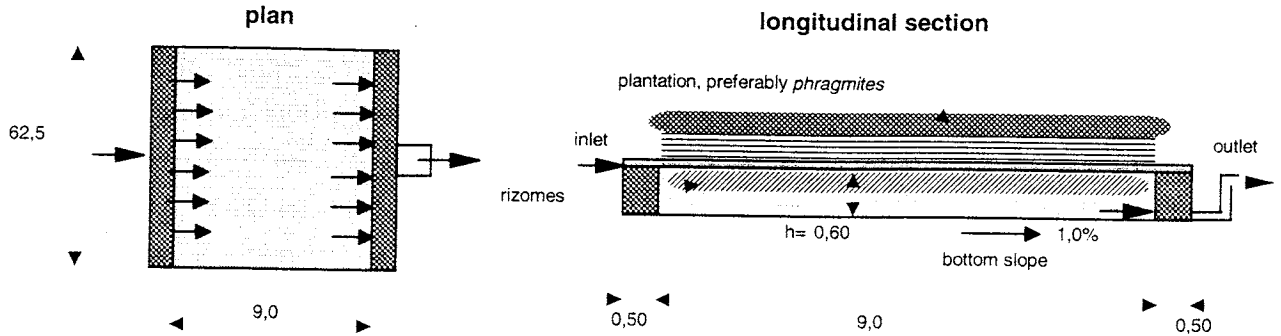

Fig. 85. Illustration to spread sheet for calculation of dimensions of horizontal gravel filters

Formulas of spread sheet „gravel filter“

D5=B5/C5

F5=1-E5/C5

G5=F5/G6

H5=B5*(1-G5)

J5=IF(F5<0,75;(F5-0,7)*8,5/5+0,52;IF(F5<0,8;(F5-0,75)*9,5/5+0,605;IF(F5<0,85;(F5-0,8)*12,5/5+0,7;IF(F5<0,9;(F5-0,85)*17,5/5+0,825;(F5-0,9)*30/5+1))))

The formula refers to Fig. 84.

K5=J5*IF(I5<15;82-(I5-10)*37/5;IF(I5<20;45-(I5-15)*31/5;IF(I5<25;24-(I5-20)*11/5;IF(I5<30;13-(I5-25)*6/5;7))))

The formula refers to Fig. 83.

G6=IF(F5<0,5;1,06;IF(F5<0,75;(F5-0,5)*0,065/0,25+1,06;IF(F5<0,85;1,125-(F5-0,75)*0,1/0,1;1,025)))

The formula refers to Fig. 65.

L6=L5/86400

A11=K5*35%

D11=IF(A5/L5/B11<A5*C5/E12;A5*C5/E12;A5/L5/B11)

The formula compares hydraulic load to maximum organic load in cell E12.

E11=D11/C11

F11=IF(A5*C5/L12>A5*K5/C11;A5*C5/L12;A5*K5/C11)

The formula compares permitted hydraulic load with organic load in cell L12

G11=F11/E11

J11=H11*I11

K11=A5/J11

L11=K11*C5

H12=E11

13.1.12 Anaerobic Pond

Anaerobic ponds may be built for sedimentation only, with very short retention times, as highly loaded ponds when heavy scum formation may be expected to seal the surface, or as relatively low loaded ponds which are almost odourless because of neutral pH values. The spread sheet may be used for all three categories, Therefore the hydraulic retention time is the „entrance parameter“. Ponds with long retention times (low organic loading rates) may be divided into several ponds in a row. The front portion may be separated to support development of scum at ponds with short retention times. The organic load of the effluent may be the major design criteria which can best be influenced by the HRT. Ambient temperature is important and should not be chosen too high for want of smaller ponds. It is assumed that temperature has no influence on COD removal at short retention times of less than 30 hours.

low.
orks
anic
han
infe-
rea-
flow
(cell

95%

RT of
°C

L
draulic nduct. Ks
liven m/d 200
1E-03
load chosen urface
alcul. BOD
9,9
10

Cell G11 should be observed and compared with F11 when the pond is near residential houses.

The biogas potential is also calculated to decide whether a closed anaerobic tank with biogas collection should be built instead.

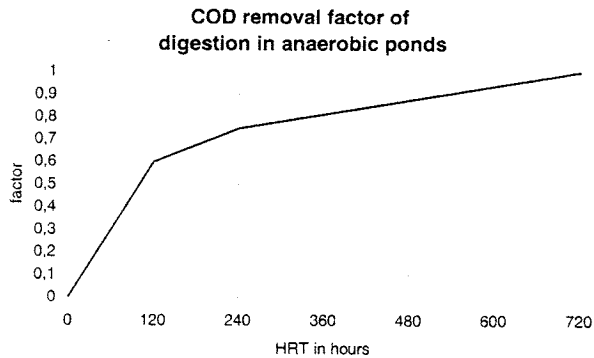

Fig. 86. Influence of HRT on COD removal of non-settled solids in anaerobic ponds

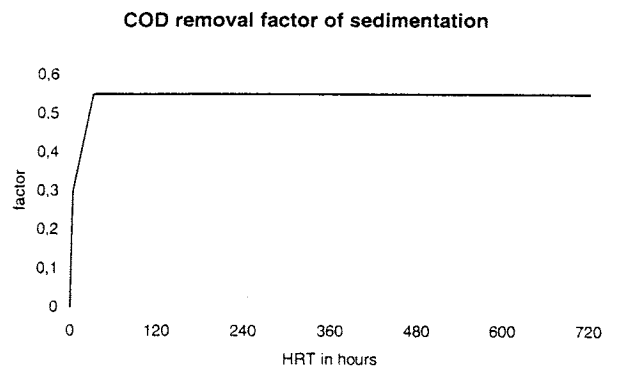

Fig. 87. Influence of HRT on COD removal of settled solids in anaerobic ponds

Tab. 29a. Spread sheet for calculation of dimensions of anaerobic sedimentation pond (short HRT). In that example the pond is extremely long and narrow to allow development of scum in the highly loaded front portion. A partition wall in the front third could support the effect. Would the pond be more square in size, there would be no highly loaded areas, but as well no sealing scum layer. Both options are possible.

	A	B	C	D	E	F	G	H	I	J
1	General spread sheet for anaerobic and sedimentation ponds									
2	daily flow	COD in	BOD ₅ in	COD / BOD ₅	HRT	settleable SS / COD ratio	ambient temp. °C	BOD ₅ removal factors		
3	given	given	given	calcul.	chosen	given	given	calculated acc. to graphs		
4	m ³ /d	mg/l	mg/l	ratio	h	mg/l / mg/l	°C	f-HRT	f-temp	f-number
5	260	2000	850	2,35	72	0,42	25	57%	100%	100%
6	domestic-> 0,35-0,45									
7	treatment data									
8	BOD ₅ removal rate	BOD / COD remov.	COD removal rate	COD out	BOD ₅ out	org. load BOD ₅ on total vol.	odourless limit of org. load	de-sludging interval	sludge accum.	sludge volume
9	calcul.	calc.	calcul.	calcul.	calcul.	calcul.	calcul.	chosen	calcul.	calcul.
10	%	factor	%	mg/l	mg/l	g / m ³ *d	g / m ³ *d	months	l/g BOD	m ³
11	57%	1,08	53%	943	366	171	263	60	0,0023	512
12										
13	dimensions					biogas potential				
14	water volume	depth of pond	total area of pond	width of ponds	total length of pond	number of ponds	length of each pond if equal	methan content	non-dissolv. methan prod.	potential biogas product.
15	calcul.	chosen	required	chosen	calcul.	chosen	calcul.	assumed	assumed	calcul.
16	m ³	m	m ²	m	m	number	m	ratio	ratio	m ³ /d
17	780	2,0	646	6,00	107,67	1	107,67	70%	50%	68,67
18										

Tab. 29b.

Spread sheet as Tab. 29a but used for calculation of dimensions of anaerobic fermentation pond (long HRT)

	A	B	C	D	E	F	G	H	I	J	
1	General spread sheet for anaerobic and sedimentation ponds										
2	daily flow	COD in	BOD ₅ in	COD / BOD ₅	HRT	settleable SS / COD ratio	ambient temp.°C	BOD ₅ removal factors			
3	given	given	given	calcul.	chosen	given	given	calculated acc. to graphs			
4	m ³ /d	mg/l	mg/l	ratio	h	mg/l / mg/l	°C	f-HRT	f-temp	f-number	
5	260	2000	850	2,35	480	0,42	25	92%	100%	108%	
6	domestic-> 0,35-0,45										
7	treatment data										
8	BOD ₅ removal rate	BOD / COD remov.	COD removal rate	COD out	BOD ₅ out	org. load BOD ₅ on total vol.	odourless limit of org. load	de-sludging interval	sludge accum.	sludge volume	
9	calcul.	calc.	calcul.	calcul.	calcul.	calcul.	calcul.	chosen	calcul.	calcul.	
10	%	factor	%	mg/l	mg/l	g /m ³ d	g /m ³ d	months	l/g BOD	m ³	
11	98%	1,03	96%	88	17	36	263	60	0,0023	881	
12											
13	dimensions							biogas potential			
14	water volume	depth of pond	total area of pond	width of ponds	total length of pond	number of ponds	length of each pond if equal	methan content	non-dissolv. methan prod.	potential biogas product.	
15	calcul.	chosen	required	chosen	calcul.	chosen	calcul.	assumed	assumed	calcul.	
16	m ³	m	m ²	m	m	number	m	ratio	ratio	m ³ /d	
17	5.200	2,5	2.432	20,00	121,62	2	60,81	70%	50%	124,29	
18											

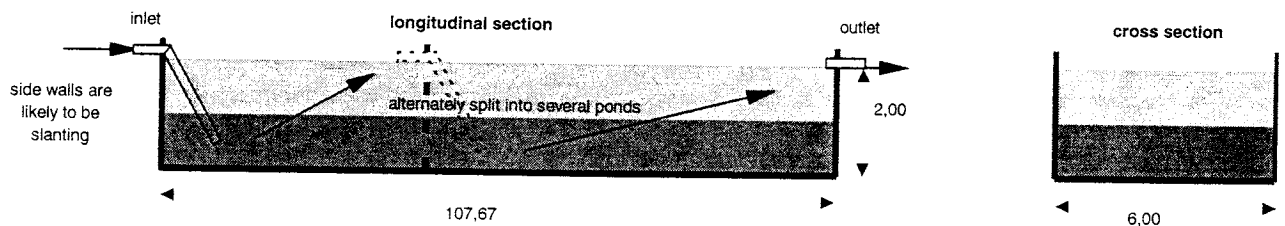

Fig. 88.

Illustration to spread sheet for calculation of dimensions of anaerobic ponds (figures of Tab.29a).

Formulas of spread sheet „anaerobic and sedimentation pond“

D5=B5/C5

H5=IF(E5<1;F5/0,6*(0,3*E5);IF(E5<3;F5/0,6*(E5-1)*0,1/2;IF(E5<30;F5/0,6*((E5-3)*0,15/27+0,4);IF(E5<120;E5*0,5*(1-0,55*F5/0,6)/120+0,55*F5/0,6;IF(E5<240;(E5-120)*0,25*(1-0,55*F5/0,6)/120+0,5*(1-0,55*F5/0,6)+0,55*F5/

0,6;IF(E5<480;(E5-240)*0,19*(1-0,55*F5/0,6)/240+0,55*F5/0,6+0,75*(1-0,55*F5/0,6);(E5-480)*0,06*(1-0,55*F5/0,6)/240+0,55*F5/0,6+0,94*(1-0,55*F5/0,6))))))

The formula refers to Fig. 86. and Fig. 87. Below 30 hours HRT is the COD removal factor influenced by settling properties (F5/0,6), longer retention times influence also non-settled solids.

$I5=IF(E5<30;1;IF(G5<20;(G5-10)*0,39/20+0,47;IF(G5<25;(G5-20)*0,14/5+0,86;IF(G5<30;(G5-25)*0,08/5+1;1,1))))$

The formula refers to Fig. 72. COD removal by sedimentation (HRT <30 hours) is not influenced by temperature.

$J5=IF(E5<24;1;IF(F17=1;1;IF(F17=2;1,08;IF(F17=3;1,12;1,13))))$

$A11=IF(H5*I5*J5<0,98;H5*I5*J5;0,98)$

$B11=IF(A11<0,5;1,06;IF(A11<0,75;(A11-0,5)*0,065/0,25+1,06;IF(A11<0,85;1,125-(A11-0,75)*0,1/0,1;1,025)))$

The formula refers to Fig. 65.

$C11=A11/B11$

$D11=B5-(C11*B5)$

$E11=C5-(A11*C5)$

$F11=A5*C5/(A17+J11)$

$G11=75%*IF(G5<10;100;IF(G5<20;G5*20-100;IF(G5<25;G5*10+100;350)))$

The formula refers to the rule of thumb given by Mara, reflected in Tab. 15.

$I11=0,005*IF(H11<36;1-H11*0,014;IF(H11<120;0,5-(H11-36)*0,002;1/3))$

The formula refers to Fig. 67.

$J11=30*A5*(C5-E11)*I11*H11/1000$

$A17=A5/24*E5$

$C17=(J11+A17)/B17$

$E17=C17/D17$

$G17=E17/F17$

$J17=A5*(B5-D11)*0,35/1000/H17*I17$

The formula assumes 350 l methane per kg COD removed.

13.1.13 Aerobic Pond

Volume of flow and pollution load are the basic entries. Starting from these data, the "entrance parameter" is the wanted effluent quality (BOD_{out} , cell F5). The HRT necessary to achieve a certain BOD removal rate depends on temperature. The curve (Fig. 91.) shows this relationship for a 90% BOD removal rate. Fig. 90. shows how HRT changes with changing treatment performance, defined as BOD removal rate at 25°C.

Sludge production may be high in aerobic ponds due to dead algae sinking to the bottom. According to Suwarnarat 1,44 g TS can be expected from 1 g BOD_5 . Assuming a 20% total solids content in compressed bottom sludge and a 50% reduction of volume due to anaerobic stabilisation, almost 4 mm of bottom sludge per gram $BOD_5 / m^3 \times d$ organic load would accumulate during one year. At loading rates of 15 g $BOD_5 / m^3 \times d$ approximately 6 cm of sludge are expected per year. However, the sludge volume has not been taken into the calculation because the surface area plays the major role for dimensioning.

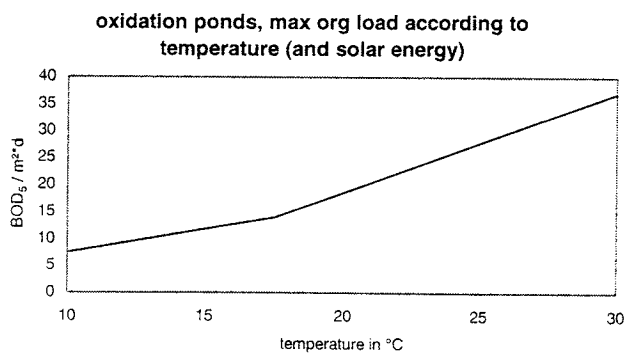

Suwarnarat, pg. 45

Fig. 89. Maximum organic load relative to temperature on aerobic-facultative oxidation ponds. The influence of sun-shine hours has been included.

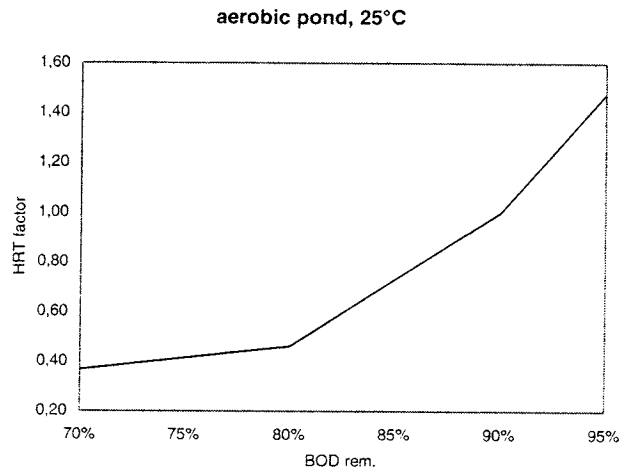

Fig. 90. Influence of desired BOD removal on HRT in aerobic-facultative ponds, based on 25°C

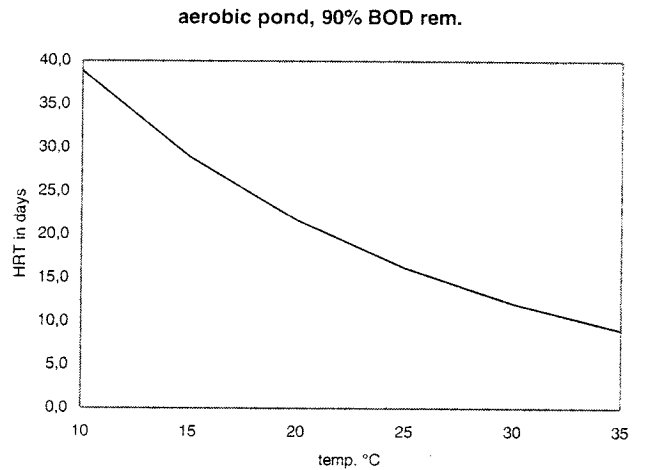

Fig. 91. Influence of temperature on BOD removal in aerobic-facultative ponds, based on desired 90% BOD removal

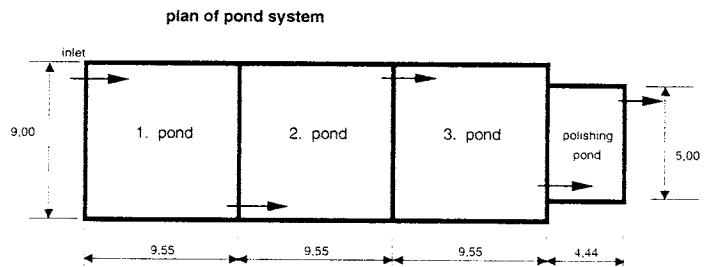

Fig. 92. Illustration to spread sheet for calculation of dimensions of aerobic-facultative ponds

Tab. 30.

Spread sheet for calculation of dimensions of aerobic-facultative ponds

	A	B	C	D	E	F	G	H	I	J	K	M
1	General spread sheet on aerobic - facultative ponds, input and treatment data											
2	daily flow	COD in	BOD ₅ in	COD / BOD ₅	min. water temp.	BOD ₅ out (wanted)	BOD rem.	COD rem	COD out	BOD ₅ rem factor for HRT	HRT	de-sludging interval
3	given	given	calcul.	calcul.	given	chosen	calcul.	calcul.	calcul.	calcul.	calcul.	chosen
4	m ³ /d	mg/l	mg/l	mg/l / mg/l	°C	mg/l	%	%	mg/l	%	days	months
5	20	500	170	2,94	20	30	82%	78%	108	0,59	12,9	12
6	0,05 - 1,0											
7	dimensions of aerobic - facultative ponds									polishing pond 1 day HRT		total
8	accum. sludge volume	permit. org. load BOD ₅	actual org. load (BOD ₅)	depth of ponds	total pond area	number of main ponds	width of ponds	length of each pond	area of polish pond	width of polish. pond	length of polish. pond	area of all ponds
9	calcul.	calcul.	calcul.	chosen	calcul.	chosen	chosen	calcul.	calcul.	chosen	calcul.	calcul.
10	m ³	g/m ² *d	g/m ² *d	m	m ²	No	m	m	m ²	m	m	m ²
11	6,3	19,3	13,2	0,9	258	3	9,00	9,55	22	5,00	4,44	796
12	0,00624	1/g BOD		0,9-1,2 m								

Formulas of spread sheet for calculation of „aerobic pond“

$$D5=B5/C5$$

$$G5=1-(F5/C5)$$

$$H5=G5*1/IF(G5<0,5;1,06;IF(G5<0,75;(G5-0,5)*0,065/0,25+1,06;IF(G5<0,85;1,125-(G5-0,75)*0,1/0,1;1,025)))$$

The formula refers to Fig. 65.

$$I5=B5-H5*B5$$

$$J5=IF(G5<0,8;(G5-0,7)*0,05/0,1+0,37;IF(G5<0,9;(G5-0,8)*0,54/0,1+0,46;(G5-0,9)*0,48/0,05+1))$$

The formula refers to Fig. 90.

$$K5=J5*IF(E5<15;39-(E5-10)*10/5;IF(E5<20;29-(E5-15)*7/5;IF(E5<25;22-(E5-20)*6/5;IF(E5<30;16-(E5-25)*4/5;12))))$$

The formula refers to Fig. 91.

$$A11=30*A5*(C5-F5)*A12*L5/1000$$

$$B11=IF(E5<17;(E5-10)*7,5/7,5+7,5;(E5-17)*23/13+14)$$

The formula refers to Fig. 89.

$$C11=A5*C5/(F11*G11*H11)$$

$$E11=IF(IF(F11=1;1;IF(F11=2;1/1,1;IF(F11=3;1/1,14;1,16)))*(A11+A5*K5)/D11>C5*A5/B11;IF(F11=1;1;IF(F11=2;1/1,1;IF(F11=3;1/1,14;1,16)))*(A11+A5*K5)/D11;C5*A5/B11)$$

The first part of the formula considers the influence of dividing the total pond area into several ponds. The second part compares permitted organic load with calculated HRT.

$$H11=E11/F11/G11$$

$$I11=A5/D11$$

$$K11=I11/J11$$

$$L11=I11+F11*E11$$

$$A12=0,0075*IF(L5<36;1-L5*0,014;IF(L5<120;0,5-(L5-36)*0,002;1/3))$$

The formula refers to Fig. 67.

13.2 Economic Computer Spread Sheets

13.2.1 General

This chapter intends to help the reader to produce his or her own tool for calculating annual costs of DEWATS. Since economic calculations always incorporate the unknown future, they are never exact. However, it would be reckless to invest in DEWATS without prior economic evaluation. The computer spreadsheet helps to calculate the annual costs, which include capital cost, operational cost and maintenance. Expected income from biogas or sale of sludge for fertiliser may be deducted. To use the spread sheet, the following data have to be collected:

- Planning cost, including transport to site and laboratory cost for initial wastewater analysis.
- Investment costs of buildings, site work and equipment
- Assumed maintenance and operational cost
- Rate of interest (minus inflation rate), and
- Wastewater data to calculate possible benefits and to compare cost per amount of treated wastewater

13.2.2. Viability of Using Biogas

Whether the use of biogas is economically viable in itself, depends on whether the necessary additional investment to facilitate storage, transport and utilisation of biogas can be recovered by the income from biogas in a reasonable time. The payback period is considered to be an adequate indicator of viability.

Formulas of spread sheet „viability of biogas“

$$B4=6,5\%*A4$$

For rough calculation it is assumed that additional construction costs are 6,5% of original costs; which include cost for making reactor roof gas-tight, for additional volume to store gas, and for gas distribution and supply pipes.

$$D4=50\%*C4$$

To guarantee permanent gas supply, additional care has to be taken at site. This additional effort is assumed to be plus 50% of normal operational cost.

$$F4=B4/(E4-D4)$$

Negative values show that costs will never be recovered.

Tab. 31.

Spread sheet for calculation the viability of necessary measures to facilitate biogas utilisation

	A	B	C	D	E	F
1	Economic viability of using biogas					
2	Investment cost without use of biogas	additional constr.cost to facilitate use of biogas	operational cost without use of biogas	additional operational cost to use biogas	income from biogas	pay back period of additional cost
3	l.c.	l.c.	l.c./year	l.c./year	l.c./year	years
4	307.000	19.955	250	125	3.650	5,7

13.2.3 Annual Cost Calculation

Tab. 32.

Spread sheet for economic calculation of DEWATS (based on annual costs).

	A	B	C	D	E	F	G	H	I	J	K
1	Calculation of annual costs of DEWATS										
2	planning and site supervision cost				investment cost					total annual cost	
3	salaries for planning and supervision	transport and allowance for visiting or staying at site	cost for wastewater analysis	total planning cost includ. overheads and akquisition	cost of plot incl. site preparation	main structures of 20 years durability	secondary structures of 10 years durability	equipment and parts of 6 years durability	total investment cost (incl. land and planning)	total annual cost (including land)	total annual cost (excluding land)
4	i.c.	i.c.	i.c.	i.c.	i.c.	i.c.	i.c.	i.c.	i.c.	i.c.	i.c.
5	1.200	650	500	2.350	150.000	295.000	9.000	3.000	459.350	74.359	62.359
6	wastewater data				annual capital costs						
7	daily wastewater flow	strength of wastewater inflow	COD/BOD ratio of inflow	strength of wastewater outflow	rate of interest in % p.a. (bank rate minus inflation)	interest factor $q = 1+i$	on investment for land	on main structures of 20 years lifetime (incl. planning fees)	on secondary structures of 10 years lifetime	on equipment of 6 years lifetime	total capital costs
8	m ³ /d	mg/l COD	mg/l / mg/l	mg/l COD	%		i.c. / year	i.c. / year	i.c. / year	i.c. / year	i.c. / year
9	20	3.000	2	450	8%	1,08	12.000	30.286	1.341	649	37.179
10	operational cost				income from biogas and other sources						explanat.
11	cost of personal for operation, mainten. and repair	cost of material for operation, mainten. and repair	cost of power (e.g. cost for pumping)	cost of treatment additives (e.g. chlorine)	total operational cost	daily biogas production (70% CH ₄ , 50% dissolved)	price 1 litre of kerosene (1m ³ CH ₄ = 0,85 l kerosene)	annual income from biogas p.a.	other annual income or savings (e.g. fertiliser, fees)	total income per annum	<i>i.c. = local currency; mg/l = g/m³;</i>
12	i.c. / year	i.c. / year	i.c. / year	i.c. / year	i.c. / year	m ³ /d	i.c./litre	i.c./year	i.c./year	i.c./year	
13	100	100	50	0	250	12,75	2,69	7.347	0	7.347	

Formulas of spread sheet „annual costs of DEWATS“

$$D5 = \text{SUM}(A5:C5)$$

$$I5 = \text{SUM}(D5:H5)$$

$$J5 = \text{SUM}(G9:K9) + E13 - J13$$

$$K5 = \text{SUM}(H9:K9) + E13 - J13$$

$$F9 = 1 + E9$$

$$G9 = E5 * E9$$

$$H9 = (F5 + D5) * (\text{POWER}(F9;20)) * (F9 - 1) / (\text{POWER}(F9;20) - 1)$$

This and the following formulas are financial standard operations; the mathematical expression is:

$$(F5 + D5) * \frac{F9^{20} * (F9 - 1)}{F9^{20} - 1}$$

$$I9 = G5 * (\text{POWER}(F9;10)) * (F9 - 1) / (\text{POWER}(F9;10) - 1)$$

the mathematical expression is:

$$G5 * \frac{F9^{10} * (F9 - 1)}{F9^{10} - 1}$$

$$J9 = H5 * (\text{POWER}(F9;6)) * (F9 - 1) / (\text{POWER}(F9;6) - 1)$$

the mathematical expression is:

$$H5 * \frac{F9^6 * (F9 - 1)}{F9^6 - 1}$$

$$K9 = \text{SUM}(G9:J9) + E13 - J13$$

$$E13 = A13 + B13 + C13 + D13$$

$$F13 = A9 * (B9 - D9) * 0,35 * 0,5 / 0,7 / 1000$$

The formula assumes 350 l biogas per kg COD removed

$$H13 = F13 * 70% * G13 * 0,85 * 360$$

$$J13 = H13 + I13$$

13.3 Using Spread Sheets without Computer

Not everybody uses a computer. Some may not even have access to a computer. However, computer formulas may also be useful to those who usually work with a pocket calculator. The explanations that follow are especially given for such persons. The table (Tab. 33.) for calculating the septic tank may be used as example:

A computer table is described in columns A.....X, AA...AX, etc. and in rows 1.....>1000. Each table consists of cells that have an address. For example, the first cell in the top left corner has the address A1 (column A, row 1). On the table below, cell J10 reads m³/d for example and cell D5 reads 633. Cell I11 reads 23,25. This figure is the result of a

formula hidden 'under' it. On the computer, the formula appears in the headline every time one hits the cell. These formulas can also be used without a computer in connection with the various graphs. One has to realise that the computer writing differs from normal mathematical writing in some points. Most important is that for example the usual $\frac{4}{3} \times 2$ is written on the computer as =4/3/2, and the usual $\frac{4 \times 2}{3}$ may be written either 4*2/3 or 4/3*2.

Cell A5 and all other bold written figures contain information to be collected and do not comprise formulas. The cells with hidden formulas are these:

C5=A5/B5
this is 13,0 [m³/d] / 12 [hours] = 1,08 [m³/hours]

Tab. 32.

Sample spread sheet which is used to help to understand computer formulas

	A	B	C	D	E	F	G	H	I	J
1	General spread sheet for septic tank, input and treatment data									
2	daily waste water flow	time of most waste water flow	max flow at peak hours	COD inflow	BOD ₅ inflow	HRT inside tank	settleable SS / COD ratio	COD removal rate	COD outflow	BOD ₅ outflow
3	given	given	calcul.	given	given	chosen	given	calcul.	calcul.	calcul.
4	m ³ /day	h	m ³ /h	mg/l	mg/l	h	mg/l / mg/l	%	mg/l	mg/l
5	13,0	12	1,08	633	333	18	0,42	35%	411	209
6	COD/BOD ₅ ->				1,90	12 - 24 h	0,35-0,45 domestic		BODrem.->	1,06
7	dimensions of septic tank									
8	de-sludging interval	inner width of septic tank	minimum water depth at outlet point	inner length of first chamber		length of second chamber		volume incl. sludge	actual volume of septic tank	biogas 70%CH ₄ ; 50% dissolved
9	chosen	chosen	chosen	requir.	chosen	requir.	chosen	requir.	check	calcul.
10	months	m	m	m	m	m	m	m ³	m ³	m ³ /d
11	12	2,50	2,00	3,13	3,10	1,56	1,55	23,46	23,25	0,72
12	sludge /g BODrem.								0,0042	

$H5 = G5/0,6 * IF(F5 < 1; F5 * 0,3; IF(F5 < 3; (F5 - 1) * 0,1 / 2 + 0,3; IF(F5 < 30; (F5 - 3) * 0,15 / 27 + 0,4; 0,55)))$
 this is (0,42 [mg/l / mg/l] / 0,6 [a given factor found by experience]) multiplied by the value taken from Fig. 68 at 18 hours HRT (shown in cell F5). The calculation is therefore:

$(0,42/0,6) \times 0,495 = 0,35 = 35\%$ (which is shown in cell H5)

$I5 = (1 - H5) * D5$

$(1 - 0,35) \times 633 = 411$ (shown in cell I5)

$J5 = (1 - H5 * J6) * E5$

$(1 - 0,35 \times 1,06) \times 333$

$E6 = D5 / E5$

$633 / 333 = 1,90$

$J6 = IF(H5 < 0,5; 1,06; IF(H5 < 0,75; (H5 - 0,5) * 0,065 / 0,25 + 1,06; IF(H5 < 0,85; 1,125 - (H5 - 0,75) * 0,1 / 0,1; 1,025)))$

This formula refers to Fig 65. Since cell H5 (the removal rate) is 35%, the value of cell J6 is found in the graph where it shows 1,06

$D11 = 2/3 * H11 / B11 / C11$

$((2/3) \times 23,46) / (2,50 \times 2,00) = 3,13$

$F11 = D11 / 2$

$3,13 / 2 = 1,56$

$H11 = IF(H12 * (E5 - J5) /$

$1000 * A11 * 30 * A5 + C5 * F5 < 2 * A5 * F5 / 24; 2 * A5 * F5 / 24; H12 * (E5 - J5) /$

$1000 * A11 * 30 * A5 + C5 * F5) + 0,2 * B11 * E11$

The formula refers via cell H12 to Fig. 67, cell H12 must be calculated first. The formula H11 says, that the total volume must be at least twice the sludge volume. One has to check whether the total volume must be calculated via the hydraulic retention time or via the double sludge volume. The total volume is the sludge volume, which is $0,0042 \times (333 - 209) \times 12 \times 30$ [days/month] $\times 13,0 / 1000$ plus the volume of water which is $1,08 \times 18 = 21,88 \text{ m}^3$. This is compared

to $2 \times 13,0 \times 18 / 24$ [hours/day], which is $19,50 \text{ m}^3$. Therefore 21,88 is bigger and must be used. In addition there is the volume of 20 cm of scum added, which is $0,2 \times 2,50 \times 3,10 = 1,55$. The total volume is $21,88 + 1,55 = 23,43$ (the computer is more exact and says $23,46 \text{ m}^3$ in cell H11

$I11 = (E11 + G11) * C11 * B11$

$(3,10 + 1,55) \times 2,00 \times 2,50 = 23,25 \text{ m}^3$

$J11 = (D5 - I5) * A5 * 0,35 / 1000 / 0,7 * 0,5$

$(633 - 411) \times 13,0 \times 0,35 \times 0,5 / (1000 \times 0,7) = 0,72 \text{ m}^3$

$H12 = 0,005 * IF(A11 < 36; 1 -$

$A11 * 0,014; IF(A11 < 120; 0,5 - (A11 - 36) * 0,002; 1/3))$

The last formula refers to Fig. 67.. The desludging interval is 12 months (cell A11) which gives a value in the graph of approx. 80% which is to be multiplied by sludge production figure of 0,005. The calculation is therefore: $0,8 \times 0,005 = 0,004$ (the computer calculates exactly 0,0042).

14 APPENDIX

Geometric formulas

rectangel	$A = a \times b$	
rectangular prism	$A = 2 \times (a \times b + a \times c + b \times c)$	$V = a \times b \times c$
trapezium	$A = \frac{a + c}{2} \times h$	
trapeziform prism		$V = \frac{h}{3} \times (a \times b + c \times d + \sqrt{a \times b \times c \times d})$
circle	$A = \pi \times r^2$	$C = 2 \times \pi \times r$
cylinder	$A(\text{mantle}) = 2 \times \pi \times r \times h$	$V = \pi \times r^2 \times h$
sphere (ball)	$A = 4 \times \pi \times r^2$	$V = \frac{4}{3} \times \pi \times r^3$
spherical segment	$A = 2 \times \pi \times r \times h$	$V = \pi \times h^2 \times \left(r - \frac{h}{3} \right)$
cone	$A(\text{mantle}) = \pi \times r \times s$	$V = \pi \times r^2 \times \frac{h}{3}$
law of pythagoras	$a^2 + b^2 = c^2$	sides of 90° triangle: 3 / 4 / 5
tangent	a / b	$\tan 45^\circ = 1$
		$\tan 30^\circ = 0,577$
		$\tan 60^\circ = 1,732$
		$\tan 90^\circ = \infty$
velocity	$v = Q / A$	$Q = v \times A; \quad A = Q / v$

Conversion factors of US-units

item	US-unit	SI-unit	US/SI-unit	SI/US-unit
length	in	cm (10mm)	2,540	0,394
	ft (12in)	m (100cm)	0,305	3,281
	yd (3 ft)	m	0,914	1,094
	mi (1.760yd)	km (1.000m)	1,609	0,621
area	in ²	cm ²	6,452	0,155
	ft ²	m ²	0,093	10,764
	yd ²	m ²	0,836	1,196
	acre	hectar (10.000m ²)	0,405	2,471
	mi ²	km ²	2,590	0,386
volume	in ³	cm ³	16,387	0,061
	ft ³	liter	28,317	0,035
	ft ³	m ³	0,0283	35,314
	gallon	litre	3,785	0,264
	yd ³ (202gal)	m ³	0,765	1,308
	acre-foot	m ³	1.233,5	0,001
force / mass	lb	N	4,448	0,225
	oz	g	28,350	0,035
	lb (16oz)	kg (1000g)	0,454	2,205
	ton (short) (2000lb)	t (1000kg)	0,907	1,102
	ton (long) (2240lb)	t (1000kg)	1,016	0,984
pressure	in H ₂ O	Pa (N/m ²)	204,88	0,005
	lb/in ²	kPa (kN/m ²)	6,895	0,145
	lb/ft ²	Pa (N/m ²)	47,88	0,021
flow rate	gal/min	l/s (86,4m ³ /d)	0,0631	15,850
	gal/d	l/s	0,0000438	22825
	gal/d	m ³ /d	0,00379	264
	(1.440gal/min)	(0,0116l/s)		
energy + power	Btu	kJ	1,055	0,948
	hp-h	MJ	2,685	0,373
	kWh	kJ	3.600	0,000
	Ws	J	1.000	0,001
	hp	kW	0,746	1,341
temperature	°F	°C	0,56(°F-32)	1,8(°C)+32
	°F	°K	0,56(°F+460)	1,8(°C)-460

	A	B	C	D	E	F	G	H	I	J
1	Flow in partly filled round pipes									
2	pipe Φ	flow height	flow area	moisted area/m	hydraulic radius	slope	roughness	flow speed	flow	
3	chosen	given	calcul.	calcul.	calcul.	chosen	estimat.	calcul.	calcul.	calcul.
4	d	h/d	A	U	rhy	s	rf	v	Q	Q
5	m	m/m	m ²	m	m	%		m/s	l/s	m ³ /h
6	0,1	0,15	0,00074	0,080	0,0093	1,0%	0,35	0,21	0,153	0,55
7	0,1	0,25	0,00154	0,105	0,0147	1,0%	0,35	0,31	0,478	1,72
8	0,1	0,35	0,00245	0,127	0,0194	1,0%	0,35	0,40	0,969	3,49
9	0,1	0,5	0,00393	0,157	0,0250	1,0%	0,35	0,49	1,932	6,96
10	0,1	0,75	0,00632	0,210	0,0302	1,0%	0,35	0,58	3,641	13,11

Formulas of spread sheet for flow in partly filled pipes (after Kutter's short formula)

$$C6=0,295*(A6/2)^2$$

All figures - as here 0,295 - are geometrical constants, referring to the flow height in relation to the diameter of the pipe

$$D6=1,591*(A6/2)$$

$$E6=C6/D6$$

$$H6=(100*\text{SQRT}(E6)/\text{(G6+SQRT}(E6))) * \text{SQRT}(E6 * F6)$$

$$I6=C6 * H6 * 1000$$

$$J6=I6 * 3,6$$

$$C7=0,614*(A7/2)^2$$

$$D7=2,094*(A7/2)$$

$$E7=C7/D7$$

$$H7=(100*\text{SQRT}(E7)/\text{(G7+SQRT}(E7))) * \text{SQRT}(E7 * F7)$$

$$I7=C7 * H7 * 1000$$

$$J7=I7 * 3,6$$

$$C8=0,98*(A8/2)^2$$

$$D8=2,532*(A8/2)$$

$$E8=C8/D8$$

$$H8=(100*\text{SQRT}(E8)/\text{(G8+SQRT}(E8))) * \text{SQRT}(E8 * F8)$$

$$I8=C8 * H8 * 1000$$

$$J8=I8 * 3,6$$

$$C9=1,571*(A9/2)^2$$

$$D9=3,142*(A9/2)$$

$$E9=C9/D9$$

$$H9=(100*\text{SQRT}(E9)/\text{(G9+SQRT}(E9))) * \text{SQRT}(E9 * F9)$$

$$I9=C9 * H9 * 1000$$

$$J9=I9 * 3,6$$

$$C10=2,528*(A10/2)^2$$

$$D10=4,19*(A10/2)$$

$$E10=C10/D10$$

$$H10=(100*\text{SQRT}(E10)/\text{(G10+SQRT}(E10))) * \text{SQRT}(E10 * F10)$$

$$I10=C10 * H10 * 1000$$

$$J10=I10 * 3,6$$

	A	B	C	D	E	F	G	H	I
1	Energy requirement and cost of pumping								
2	flow rate	main flow h/d	flow rate per hour	pump height	assumed head loss	efficiency of pump	required power of pump	cost of energy	annual energy cost
3	m ³ /d	h	m ³ /h	m	m	η	kW	ECU/kWh	ECU
4	26	10	2,6	10	3	0,5	0,18	0,15	100,85

Formulas of spread sheet for cost of pumping

$$C4=A4/B4$$

$$G4=9,81*(D4+E4)*C4/F4/3600$$

$$I4=B4 * G4 * 365 * H4$$

Sedimentation and Floatation

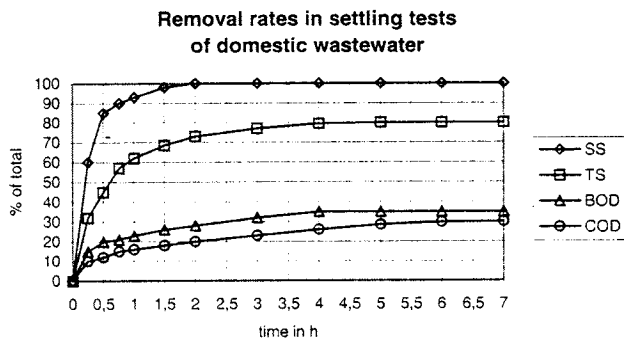

The above graph shows the results of settling tests in a jar test under batch conditions (SS = settleable solids, TS = total solids; COD is measured as $\text{COD}_{\text{KMnO}_4}$). The curve might be different in through-flow settlers. The more turbulent the flow, the lesser is the removal rate of settleable solids. The more old and new wastewater mixes the higher might be the BOD and COD removal rates.

The performance of a settler is sufficient when the effluent of domestic wastewater contains less than 0,2 ml/l settleable sludge after 2 h jar test.

Flocculent sludge has a settling velocity between 0,5 and 3 m/h.

The velocity in a sand trap should not exceed 0,3 m/s [1000 m/h]. The minimum cross section area is then:

$$\text{Area [m}^2\text{]} = \text{flow [m}^3\text{/s]} / 0,3 \text{ [m/s]}, \text{ or}$$

$$\text{Area [m}^2\text{]} = \text{flow [m}^3\text{/h]} / 1000 \text{ [m/h]}$$

The general formula for floatation and sedimentation is:

$$\text{watersurface [m}^2\text{]} = \frac{\text{waterflow [m}^3\text{/h]}}{\text{velocity [m/h]}}$$

where *velocity* is the slowest floatation or settling velocity of the particles.

Settling and floatation time can be observed in a glass cylinder. The formula is then:

$$\text{velocity [m/h]} = \frac{\text{height [m]}}{\text{time [h]}}$$

where *velocity* is settling or floatation velocity, *height* is height of cylinder, and *time* is the observed settling or floatation time.

15 LITERATURE

- Abwassertechnische Vereinigung e.V. Editor, "Lehr- und Handbuch der Abwassertechnik", Vol. I -VI, 3rd Edition, Wilhelm Ernst und Sohn, Berlin, München, Düsseldorf, 1982
- Alaerts, G.J., Veenstra, S., Bentvelsen, M., van Duijl, L.A. et al., "Feasibility of Anaerobic Sewage Treatment in Sanitation Strategies in Developing Countries" IHE Report Series 20, International Institute for Hydraulic and Environmental Engineering, Delft, 1990
- Bachmann, A., Beard, V.L. and McCarty, P.L., "Performance characteristics of the anaerobic baffled reactor", Water Science and Technology, IAWQ, 1985
- Bahlo, K., Wach, G., "Naturnahe Abwasserreinigung - Planung und Bau von Pflanzenkläranlagen", 2nd edition, Ökobuch, Staufen bei Freiburg, 1993
- Batchelor, A. and Loots, P., "A Critical Evaluation of a Pilot Scale Subsurface Flow Wetland: 10 Years After Commissioning", Water Science and Technology, Vol. 35, No. 5, IAWQ 1997
- Bischof, W. (Hosang/Bischof), "Abwassertechnik", 9th edit., B.G. Teubner Verlag, Stuttgart, 1989
- Blum, D. and Feachem, R.G., "Health Aspects of Nightsoil and Sludge Use in Agriculture and Aquaculture" IRCWD Reprint No. 05/85, (reprint 1997), EAWAG / SANDEC, Dübendorf CH, 1997
- Boller, M., "Small Wastewater Treatment Plants - a challenge to Wastewater Engineers", Water Science and Technology, Vol. 35, No. 6, IAWQ 1997
- Brix, H., "Do Macrophytes Play a Role in Constructed Wetlands?", Water Science and Technology, Vol. 35, No. 5, IAWQ 1997
- Central Pollution Control Board Delhi, "Guidelines on Environmental Management in Industrial Estates", Programme Objective Series, Probes/43/1989-90, Delhi, 1990
- Cooper P.F., Hobson J.A., Findlater C., "The use of reed bed treatment systems in the UK", Proceedings of conference on small wastewater treatment plants, edited by Hallvard Odegaard, Trondheim, 1989
- Cooper, P.F. (edit.), "European Design and Operations Guidelines for Reed Bed Treatment Systems" (revised document), EC/EWPCA Emergent Hydrophyte Treatment Systems Expert Contact Group, Swindon, UK 1990
- Cross, P., Strauss, M., "Health aspects of nightsoil and sludge use in agriculture and aquaculture", IRCWD, Dübendorf CH, 1986
- De Vries J., "Soil filtration of wastewater effluent and mechanism of pore clogging", JWPCF, vol.44, 1972
- Denny, P., "Implementation of Constructed Wetlands in Developing Countries", 5th International Conference on Wetland Systems for Waste Pollution control, Vienna, 1996
- Department of Environmental Protection and Energy, Ministry of Agriculture, P.R. of China, "Biogas and Sustainable Agriculture", Collection of Papers from the National Experience Meeting in Yichang, Hubei Province 1992, published in co-operation with BORDA, Bremen, 1993
- Driouache, A. et al., "Biogasnutzung in der Abwasserstation von Ben Sergao (Marokko) - Methoden und Ergebnisse", CDER/PSE (GTZ), Eschborn, 1997
- Driouache, A. et al., "Promotion de l'utilisation du biogaz produit dans des stations d'épuration au Maroc", CDER/PSE (GTZ), Marrakech, 1997
- Ellenberg, H. et al., "Biological Monitoring - Signals from the Environment", GATE/GTZ publication, Vieweg Verlag, Eschborn/ Braunschweig, 1991
- Fasteneau F., Graaf J; and Martijnse G., "Comparison of various systems for on site wastewater treatment", Proceedings of conference on small wastewater treatment plants, edited by Hallvard Odegaard, Trondheim, 1989
- Garg, S. K., "Sewage Disposal and Air Pollution Engineering", 9th revised edit., Khanna Publishers, New Delhi 1994
- Geller, G., "Horizontal Subsurface Flow Systems in the German Speaking Countries: summary of long-term scientific and practical experiences", Water Science and Technology, Vol. 35, No. 55, IAWQ 1997

- Grau, P., „Low Cost Wastewater Treatment“, *Water Science and Technology*, Vol. 33, No 8, IAWQ, 1996
- GRET, „Water and Health in Underprivileged Urban Areas“, PS Eau - Edition GRET, France, 1994
- Grobicki, A. and Stuckey, D.C., „Performance of the anaerobic baffled reactor“, Poster Papers, Fifth International Symposium on Anaerobic Digestion, Bologna, May 1988
- Hagendorf, U., „Verbleib von Abwasserinhaltsstoffen bei Pflanzenkläranlagen im Langzeitbetrieb“, FGU-Seminar: Naturnahe Abwasserbehandlung durch Pflanzenkläranlagen, Berlin 1997
- Hamburger Umwelt Institut e. V. and O Instituto Ambiental, „Biomass Nutrient Recycling - purifying water through agricultural production“, Hamburg/Silva Jardim, 1994
- Hanqing Yu, Joo-Hwa Tay and Wilson, F., „A Sustainable Municipal Wastewater Treatment Process for Tropical and Subtropical Regions in Developing Countries“, *Water Science and Technology*, Vol. 35, No. 9, IAWQ 1997
- Heinss, U., Larmie, S.A., Strauss, M., „Solids Separation and Pond Systems for the Treatment of Faecal Sludges in the Tropics“, EAWAG/SANDEC, Dübendorf CH, 1998
- Imhoff, K. and Imhoff, K.R., „Taschenbuch der Stadtentwässerung“, 27th edit, R. Oldenbourg Verlag, München, Wien, 1990
- Inamori, Y. et.al., „Sludge Production Characteristics of Small Scale Wastewater Treatment Facilities Using Anaerobic/Aerobic Biofilm Reactors“, *Water Science and Technology*, Volume 34, No. 3-4, IAWQ 1996
- Jenssen, P.D. and Siegrist, R.L., „Technology assessment of wastewater treatment by soil infiltration systems“, Proceedings of conference on small wastewater treatment plants, edited by Hallvard Odegaard, Trondheim, 1989
- Johnstone, D.M.W. and Horan, N.J., „Institutional Development Standards and River Quality: A UK History and Some Lessons for Industrialising Countries“, *Water Science and Technology*, Vol. 33, No. 3, IAWQ 1996
- Kadlec, Robert H. and Knight, Robert L., „Treatment Wetlands“, Lewis Publishers; Boca Raton, New York, London, Tokyo, 1996
- Karstens, A. and Berthe-Corti, L., „Biologischer Hintergrund zur anaeroben Klärung von Abwässern“ University of Oldenburg/BORDA 1996
- Khanna, P. and Kaul, S.N. „Appropriate Waste Management Technologies for Developing Countries“, Selected proceedings of the 3rd IAWQ specialized conference on Appropriate Waste Management Technologies for Developing Countries, Nagpur, 1995
- Knoch, W., „Wasserversorgung, Abwasserreinigung und Abfallentsorgung - Chemische und analytische Grundlagen“, VCH Verlagsgesellschaft, Weinheim, 1991
- Kraft, H., „Alternative Decentralized Sewage Systems in Regions of Dense Population - Root Zone Treatment Plants and other Systems“, Indo-German Workshop on Root Zone Treatment Systems, CPCB/GTZ, New Delhi, 1995
- Kunst, S. and Flasche, K., „Untersuchung zur Betriebssicherheit und Reinigungsleistung von Kleinkläranlagen mit besonderer Berücksichtigung der bewachsenen Bodenfilter“, Abschlußbericht, ISAH, University of Hannover, 1995
- Lago, S. and Boutin, C., „Etude comparative des procédés d'épuration biologique dans le contexte africain“, CEMAGREF L132, 1991
- Liao Xianming, „Anaerobic Digester for Stabilizing Domestic Sewage“, BRTC, Chengdu, 1993
- Lienard, A. and Coll., „Coupling of reed bed filters and ponds - an example in France“, CEMAGREF, Lyon, 1994
- Loll, U., „Vergleich zwischen Wurzelraum-entsorgungs- und Teichkläranlage am Projekt Brandau“ BMFT/ATV Seminar: Naturnahe Verfahren der Abwasserbehandlung, Pflanzenkläranlagen, Essen-Heidhausen, 1989
- Maeseneer, J.D. and Cooper, P., „Vertical Versus Horizontal-Flow Reedbeds for Treatment of Domestic and Similar Wastewaters“, IAWQ specialist Group Newsletter No. 16, June 1997
- Mara, D., „Design Manual for Stabilization Ponds in India“, Ministry of Environment and Forests / DFID, published by Lagoon Technology International Ltd., Leeds, 1997
- Mudrak, K. and Kunst, S., „Biologie der Abwasserreinigung“, 3. Auflage, Gustav Fischer Verlag, Stuttgart, 1991

- Orozco, A., „Anaerobic wastewater treatment using an open plug flow baffled reactor at low temperature“, Poster Papers, Fifth International Symposium on Anaerobic Digestion, Bologna, May 1988
- Pande, D.R., De Poli, F. and Tilche, A., „Some aspects of horizontal design biogas plants“ Poster Papers, Fifth International Symposium on Anaerobic Digestion, Bologna, May 1988
- Pandey, G.N. and Carney, G.C., „Environmental Engineering“, Tata McGraw-Hill Publishing Company Ltd, Delhi, 1992
- Pedersen, P., „Ecology and Urban Planning“, Working Paper No.1, Dept. Of Human Settlements, The Royal Danish Academy of Fine Arts, Copenhagen, 1991
- Platzer, Chr. and Mauch, K., „Evaluations concerning Soil Clogging in Vertical Flow Reed Beds“, 5th International Conference on Wetland Systems for Waste Pollution Control, Vienna 1996
- Polprasert, C., „Organic Waste Recycling“, Asian Institute of Technology, Bangkok, 1989
- Rybczynski, W., Polprasert, C.M., and McGarry, „Low Cost Technology Options for Sanitation - A State of the Art Review and Annotated Bibliography“, IDRC 102 e, Ottawa, 1978
- Sasse, L. and Otterpohl, R., „Status Report on Decentralised Low Maintenance Wastewater Treatment Systems (LOMWATS)“, produced by BORDA in cooperation with AFPRO, CEEIC, GERES, HRIIE and SIITRAT. Commission of the European Union - Brussels and State Office for Development Co-operation - Bremen, Bremen 1996
- Sasse, L., Kellner, C. and Kimaro, A., „Improved Biogas Unit for Developing Countries“, GATE publication, Vieweg Verlag, Braunschweig, Wiesbaden, 1991
- Schertenleib, R., „Improved Traditional Nightsoil Disposal in China - An Alternative to the Conventional Sewerage System?“, SANDEC-News, No.1, Dübendorf CH, 1995
- Schierup, H.H. and Brix, H., „Danish experience with emergent hydrophyte treatment systems (EHTS) and prospects in the light of future requirements to outlet water quality“, Proceedings of conference on small wastewater treatment plants, edit. Hallvard Odegaard, Trondheim, 1989
- Shuval, H., Coll, J., „Wastewater Irrigation in Developing Countries - health effects and technical solutions“, World Bank No. 51, Washington DC, 1986
- Strauss, M., Blumenthal, U.J., „Human Waste Use in Agriculture and Aquaculture“ Executive Summary, IRCWD Report No. 09/90, IRCWD, Dübendorf CH, 1990
- Suwarnarat, K., „Abwasserteichverfahren als Beispiel naturnaher Abwasserbehandlungsmaßnahmen in tropischen Entwicklungsländern“, (Dissertation), Darmstadt, 1979
- United States Environmental Protection Agency (EPA), „Constructed Wetlands and Aquatic Plant Systems for Municipal Wastewater Treatment“, EPA/625/1-88/022, Cincinnati, 1988
- United States Environmental Protection Agency (EPA), „Small Community Wastewater Systems“, EPA/600/M-91/032, Washington, 1991
- United States Environmental Protection Agency, „Wastewater Treatment/ Disposal for Small Communities“, Design Manual, EPA/625/R-92/005, Cincinnati, 1992
- Winblad, U. and Kilama, W., „Sanitation without Water“, revised and enlarged edition, Macmillan, London 1985, quoted in U. Winblad, „Recent Development in Sanitation“, International Symposium on Integrated Water Management in Urban Areas, Lund, 1995
- Wissing F., „Wasserreinigung mit Pflanzen“, Verlag Eugen Ulmer, Stuttgart, 1995
- World Bank and World Health Organization, „Health aspects of wastewater and excreta use in agriculture and aquaculture - The Engelberg report“ - IRCWD, No.23, 1985
- World Health Organization, „Health Guidelines for the Use of Wastewater in Agriculture and Aquaculture“, WHO Technical Report Series 778, Geneva, 1989
- Yang Xiushan, Garuti, G., Farina, R., Parsi, V. and Tilche, A., „Process differences between a sludge bed filter and an anaerobic baffled reactor treating soluble wastes“, Poster Papers, Fifth International Symposium on Anaerobic Digestion, Bologna, May 1988

KEYWORDS

aerobic facultative		<i>see aerobic</i>	COD removal in anaerobic filters	13.1.8
aerobic ponds	9.12.2		COD removal in anaerobic ponds	13.1.12
aerobic process	5.3		COD removal in settlers	13.1.6
aerobic respiration	5.2		COD/BOD ratio	7.5
air/gas mixture	12.5		colloids	7.2
albuminoid nitrogen	7.6		compost	10.3
amino acids	5.2		constructed wetland	9.9
ammonium	7.6		cost of treatment, annual costs	4.2, 13.2.3
anaerobic fermentation	5.2		cost-benefit on biogas	4.3-4, 13.2.2
anaerobic filter	9.4		Darcy's law	9.10
anaerobic ponds	9.12.1		de-nitrification	5.6
anaerobic process	5.3		DEWATS	2.1.1
anoxic conditions	5.4		difficult degradable	5.4
anoxic respiration	5.2		discharge standards	3.6.2
aquatic plants	9.12.3		discharge standards, India	3.4.2
area requirement	2.1.4		diseases, water borne	7.11
autolysis	5.5.4, 9.10		dissemination, pre-conditions	3.2
baffled septic tank (baffled reactor)	9.6		domestic wastewater	3.7.3.2
bio-chemical process	5.1		dosing chamber	9.11
biogas plant	12.3, 13.1.10		easily degradable	5.4
biogas production	12.1		enzymes	5.2
biogas, pressure gauge	12.4		expertise	3.5ff, 3.7.1.4
black box	3.5.1		facultative ponds	9.12.2
BOD - bio-chemical oxygen demand	7.5		fertiliser value	11.4
BOD removal in aerobic ponds	13.1.13		filtered BOD	3.6.2
BOD removal in baffled tanks	13.1.9		fish ponds	11.3
BOD removal in gravel filters	13.1.11		flow rate	7.1, 8.1
BOD/N ratio	7.6		gas storage	12.3
BOD/P ratio	7.7		glucose	5.2
BOD ₅	7.5		grain size	5.5.4, 9.10
C/N/P/S-ratio	5.2		H ₂ S release in ponds	9.12.1
carbohydrates	5.2		head loss	9.3, 9.4
chlorination practice	5.9			
COD - chemical oxygen demand	7.5			

KEYWORDS

health guide lines	11.1	rate constant	8.2
heavy metals	5.8	rate of interest	13.2
hybrid reactor	9.13	retention time	8.1
hydraulic load	8.1	rotating disc reactor	9.14
hydraulic retention time	8.1	rule of three	13.1.3
industrial wastewater	3.7.3.2	sand, gravel properties	9.10
Kjeldahl-N	7.6	screen	5.5.1
lamella separator	5.5.3	scum	5.5.3
lemna	9.12.3	sedimentation ponds	9.12.1
maintenance	2.4.5, 3.5.1, 3.7.1.5	septic tank	9.2, 13.1.6
marketing	3.7.3.3	settling, sedimentation	5.5.2
metabolism	5.2	sludge accumulation	8.3
methane	12.1	sludge drying bed	10.2
nitrate	5.2, 6.2	sludge production	5.3
nitrification	5.6	sludge properties	8.3
nitrite	6.2	sludge removal	9.3, 10.1
N _{kjel} -kjeldahl nitrogen	7.6	sludge volume	13.3.2
noxious substance units	5.8	social acceptance	3.3
odour	7.4	solids in domestic wastewater	7.2, 8.3
organic loading rates	8.2	specific filter surface	13.1.8
organic total solids	7.2	stormwater	7.1, 9.10
oxidation ditch	9.14	suspended solids	7.2
oxidation ponds	9.12.2, 13.1.13	temperature	7.8
oxygen intake via surface	6.1	tipping bucket	9.11
oxygen recovery	6.1	toxic concentrations	7.5
papyrus	9.12.2	trace elements	5.2
pathogens	7.11	treatment quality	2.2.1
pathogens, survival time	11.1	treatment steps	5.1, 8.2
pH	7.8	velocity	8.1, 9.6
phase separation	5.4	vertical filter	9.9, 9.11
phosphorous	5.7	viability biogas	13.2.2
phragmites	9.10	void space	9.10
ponds	9.12	volatile fatty acids	7.9
projects	3.7.2.3	wastewater per capita	13.1.5
		wastewater strength	13.1.9
		waterhyacinth	9.12.3

This book is for development planners and project managers who intent to disseminate decentralised wastewater treatment systems. The book helps to understand the scope and requirements of the technology.

This book is for engineers who need a tool for designing wastewater treatment plants. The book helps to decide about the most suitable treatment system and enables the engineer to produce calculation spread sheets for dimensioning and annual cost calculations on the computer programme he or she is familiar with.

The book is for anybody who needs to understand the reason for wastewater treatment and the basic principles of the various treatment processes. The book explains the most common parameters of wastewater analysis.