

**PUPILS CHAIR: SIZE 1 (6 - 9 YEARS)**

**CUTTING LIST**

- SIDE A: 2N°
- SIDE B: 2N°
- BACKREST C/SEAT SUPPORT D: 2N°
- BACKREST E/SEAT SUPPORT F: 2N°
- SEAT G: 2N°

Note: all joints and contact surfaces to be coated with PVA adhesive

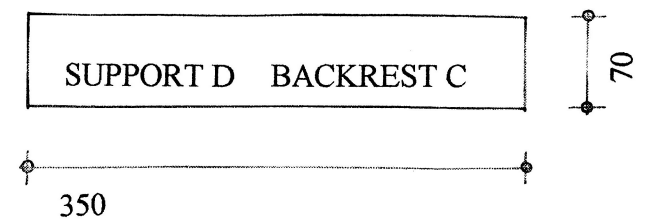
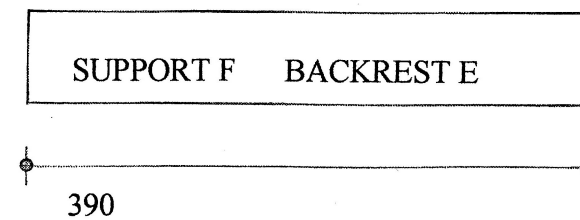
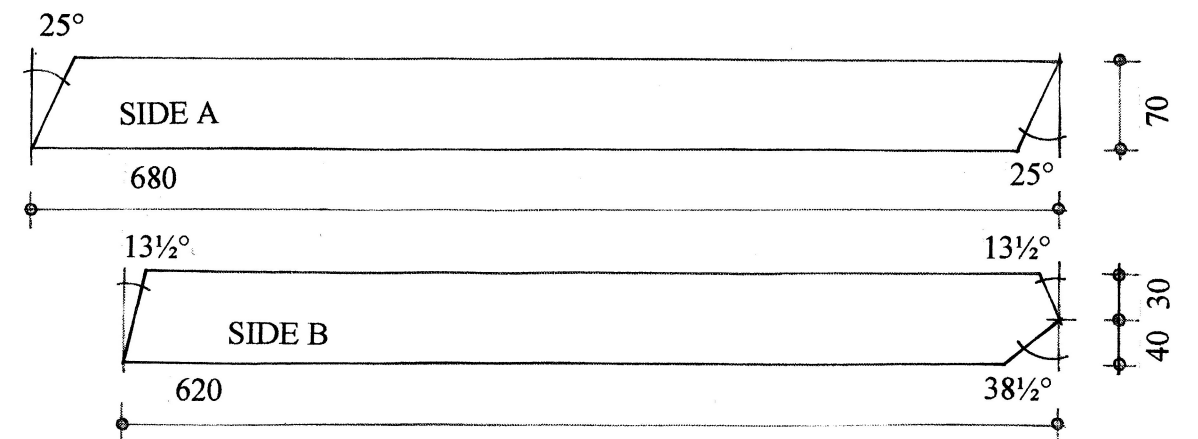
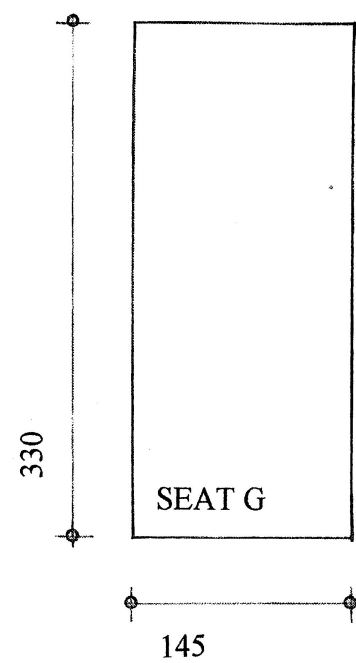
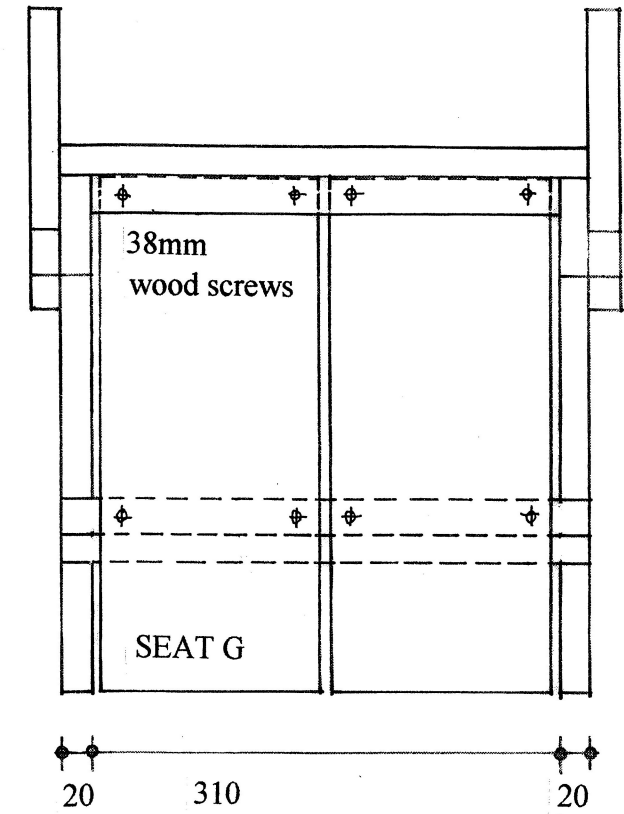

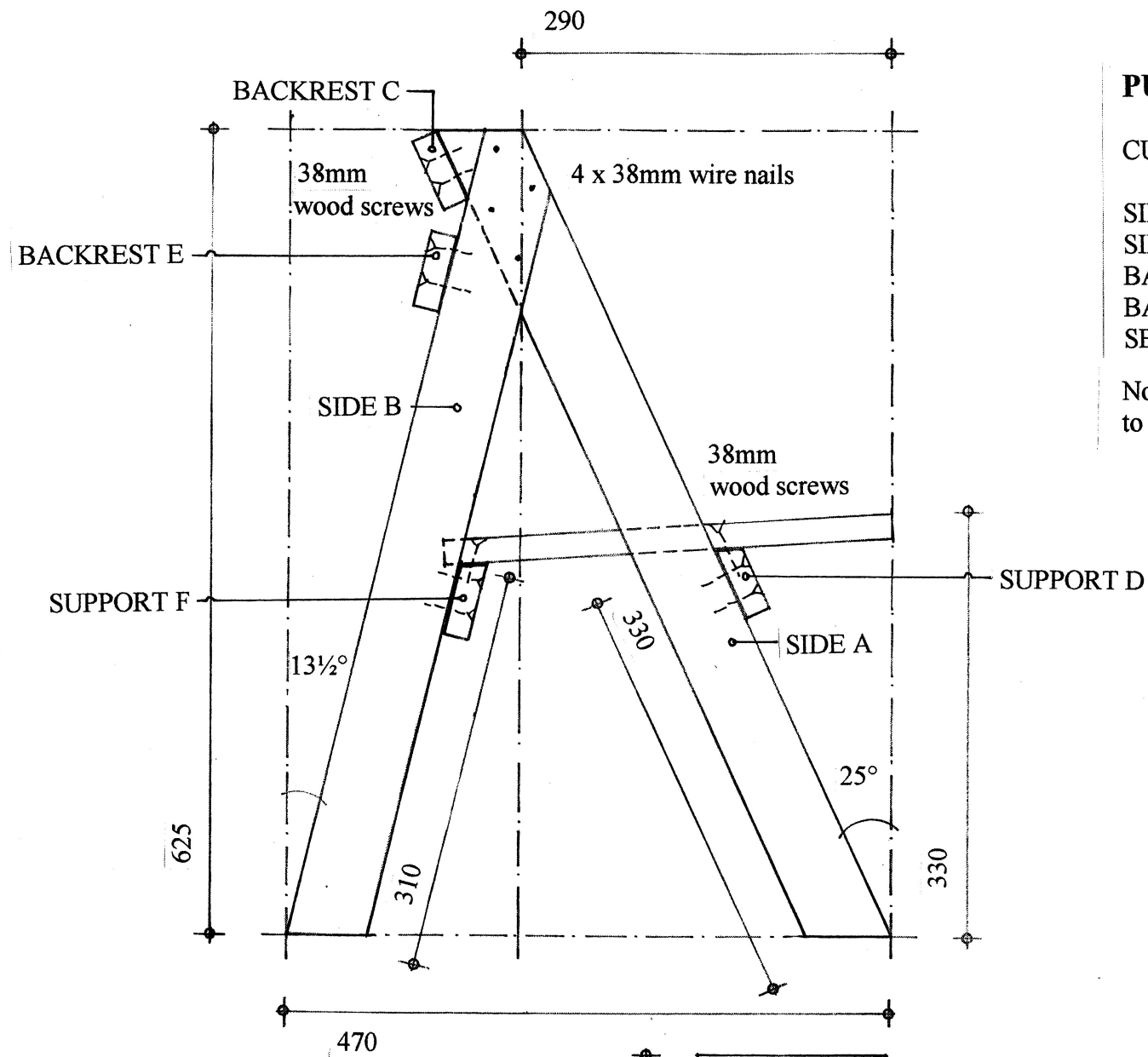

**PUPILS CHAIR: SIZE 2 (9 - 12 YEARS)**

**CUTTING LIST**

- SIDE A: 2N°
- SIDE B: 2N°
- BACKREST C/SEAT SUPPORT D: 2N°
- BACKREST E/SEAT SUPPORT F: 2N°
- SEAT G: 2N°

Note: all joints and contact surfaces to be coated with PVA adhesive

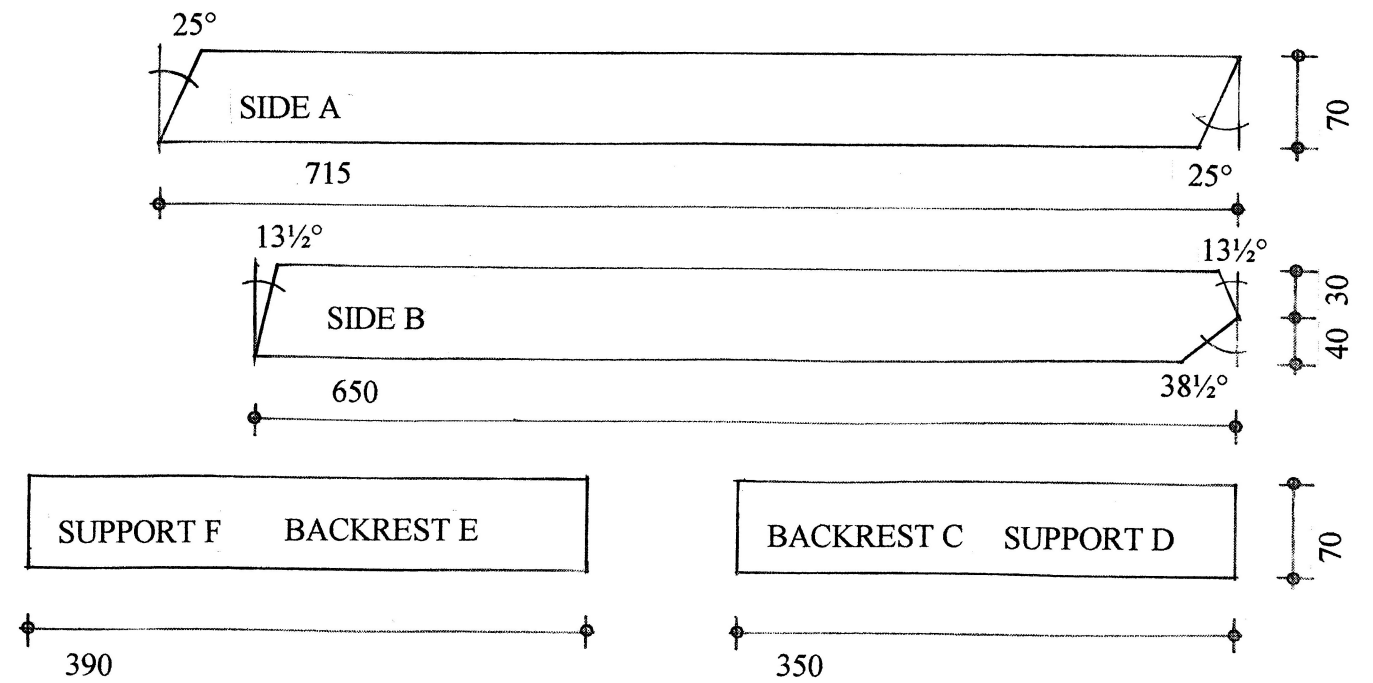
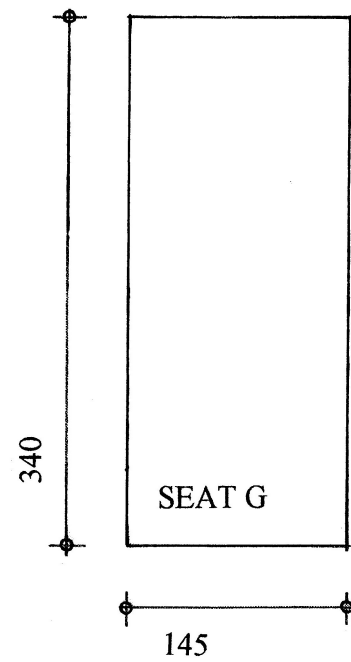
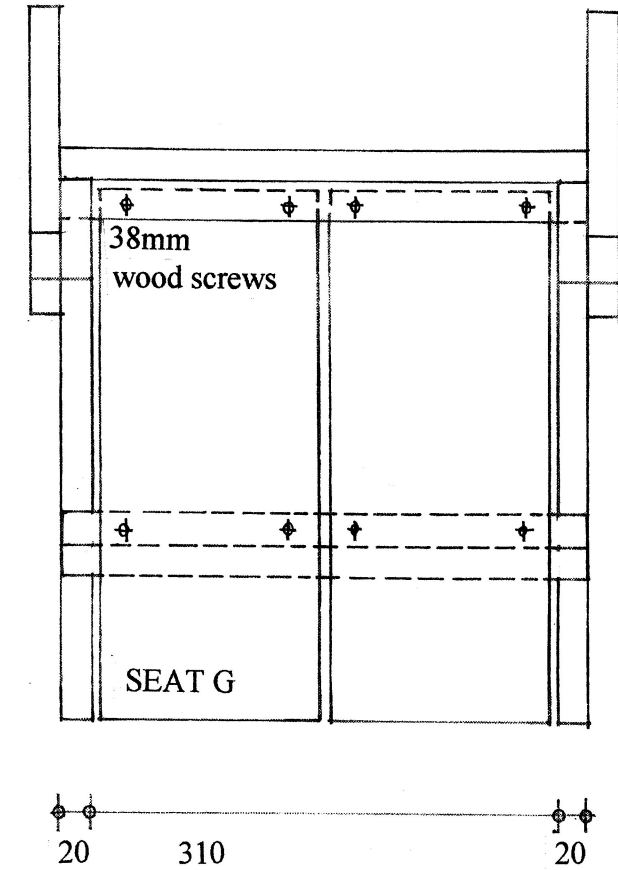

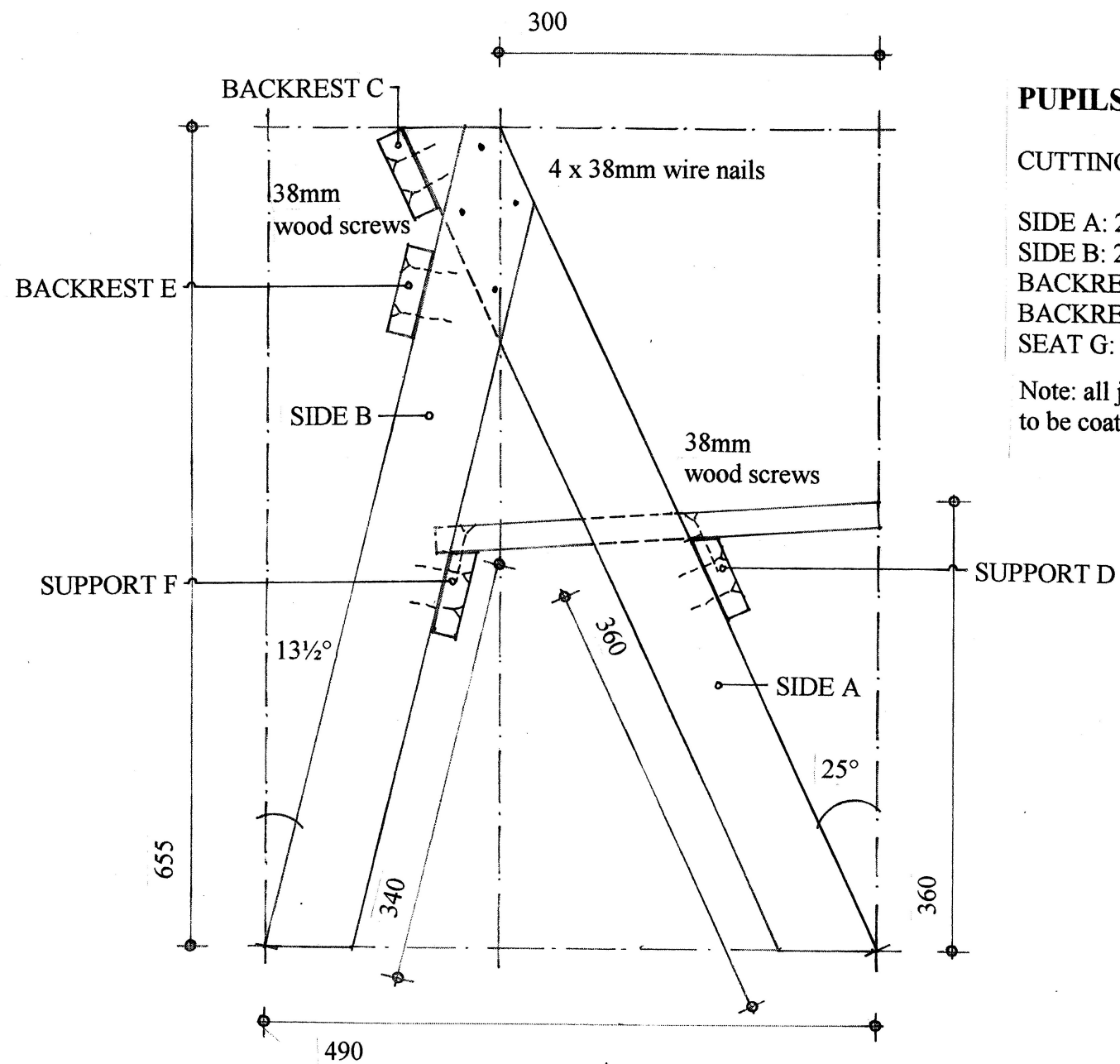

### PUPILS CHAIR: SIZE 3 (12 - 15 YEARS)

#### CUTTING LIST

- SIDE A: 2N°
- SIDE B: 2N°
- BACKREST C/SEAT SUPPORT D: 2N°
- BACKREST E/SEAT SUPPORT F: 2N°
- SEAT G: 2N°

Note: all joints and contact surfaces to be coated with PVA adhesive

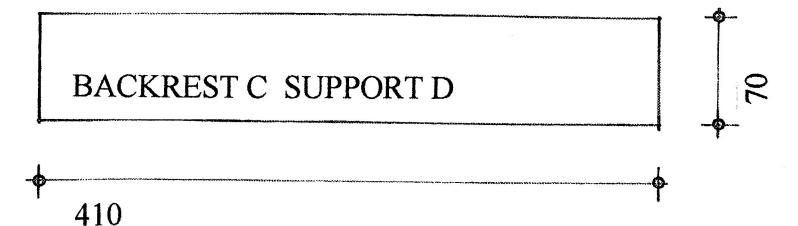
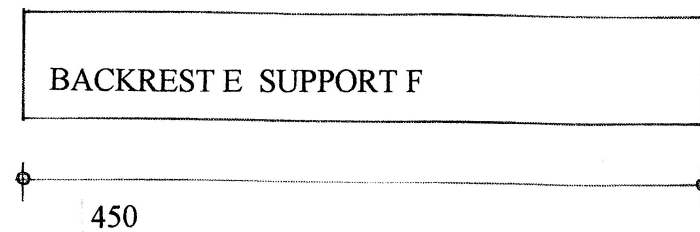
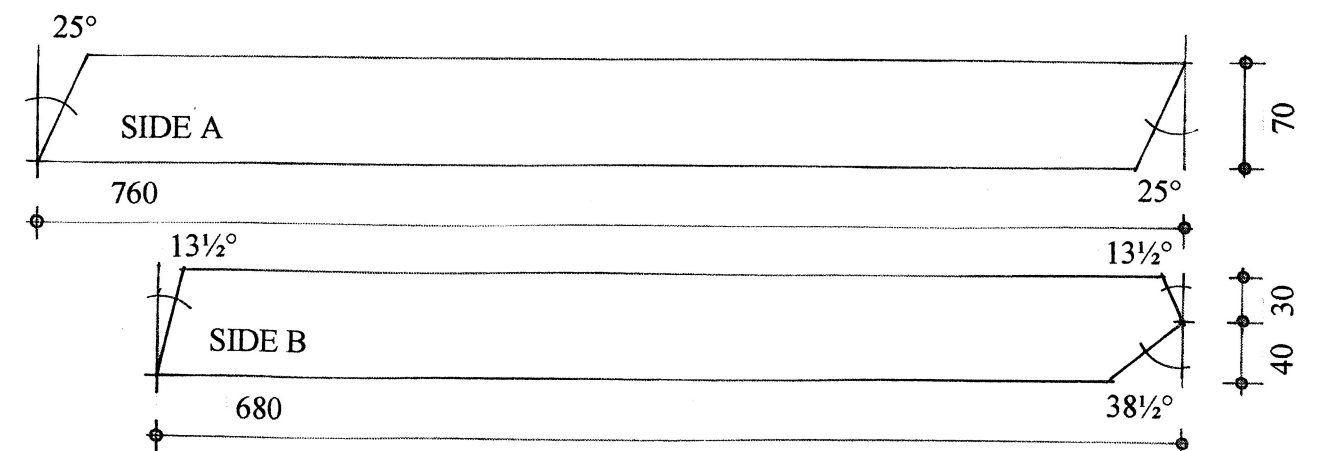
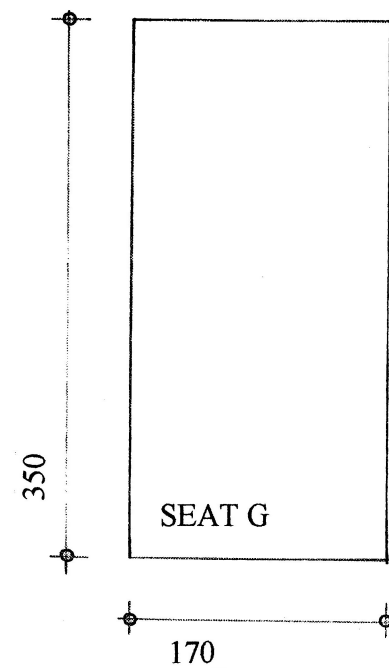
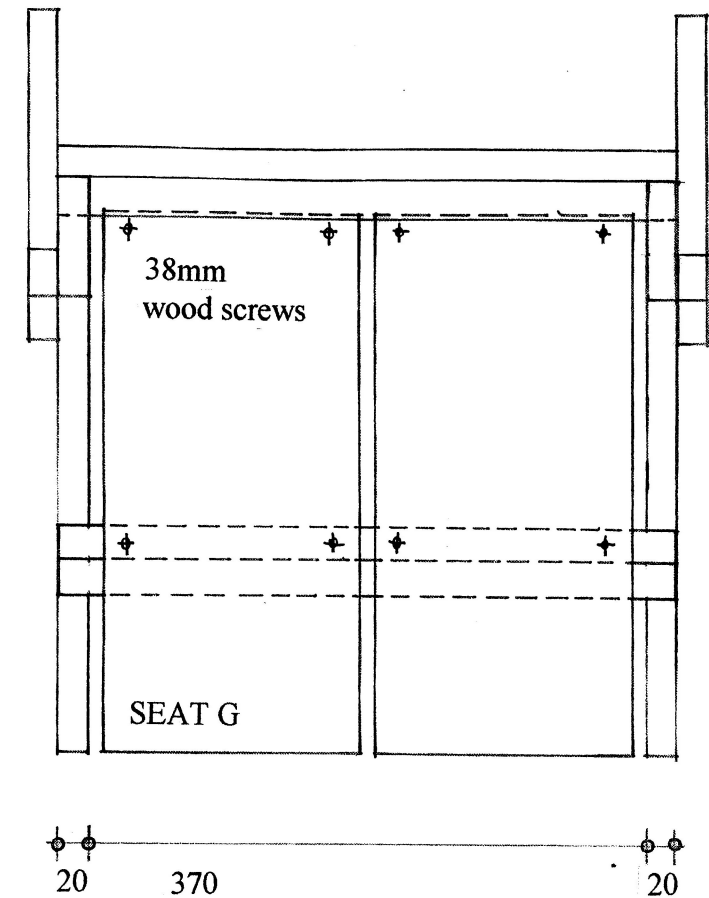

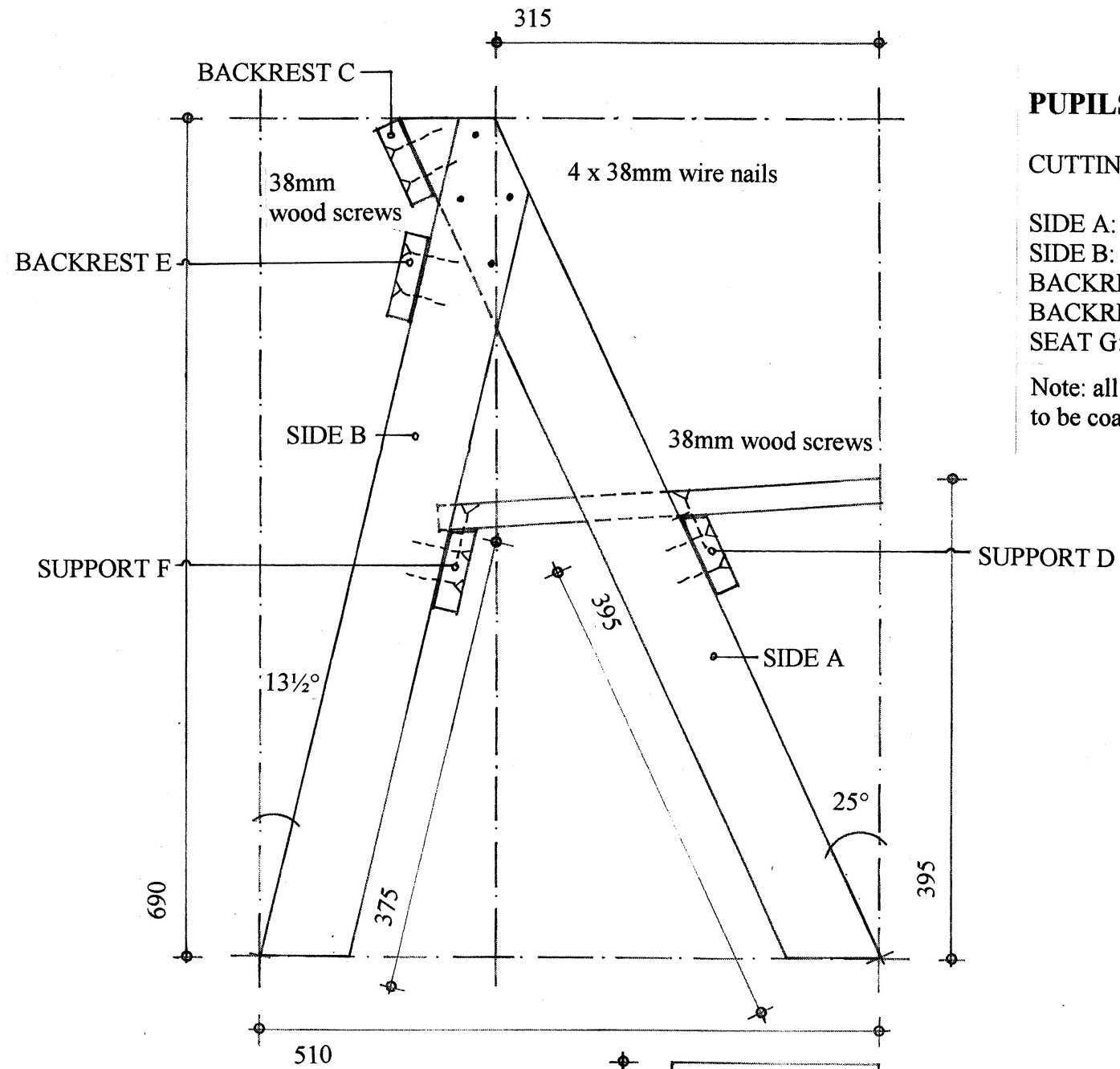

**PUPILS CHAIR: SIZE 4 (15 – 17 YEARS)**

**CUTTING LIST**

- SIDE A: 2N°
- SIDE B: 2N°
- BACKREST C/SEAT SUPPORT D: 2N°
- BACKREST E/SEAT SUPPORT F: 2N°
- SEAT G: 2N°

Note: all joints and contact surfaces to be coated with PVA adhesive

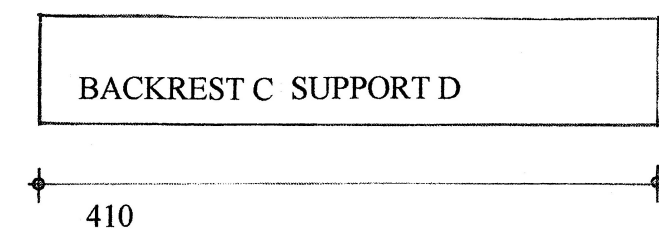
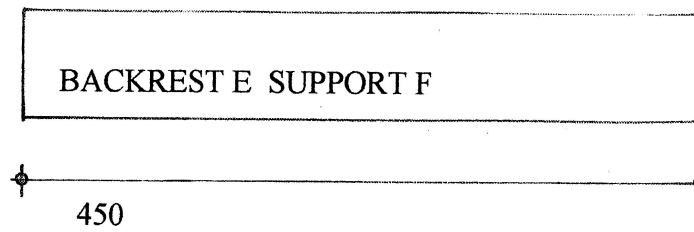
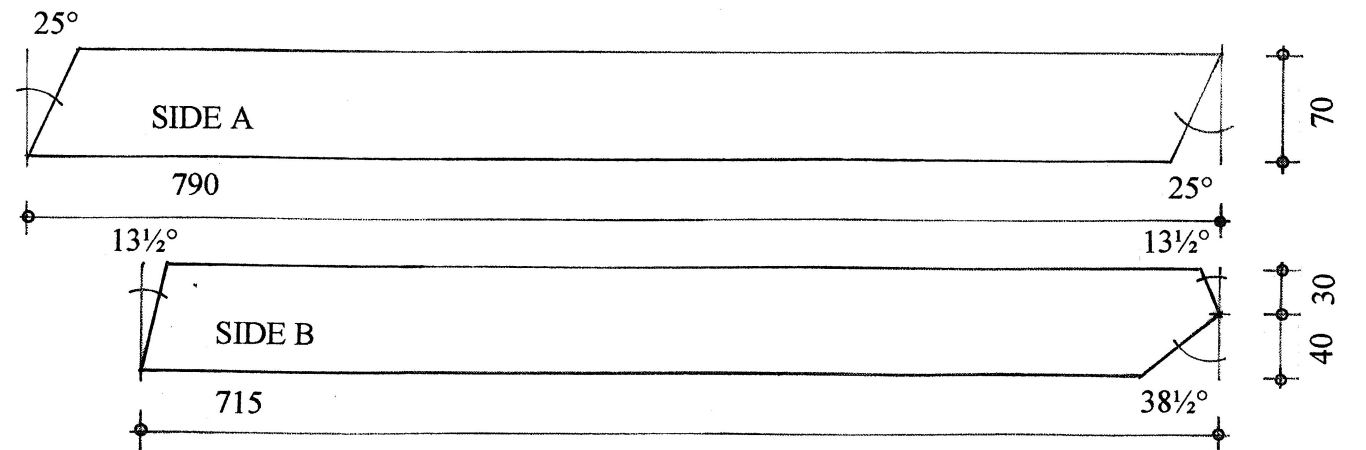
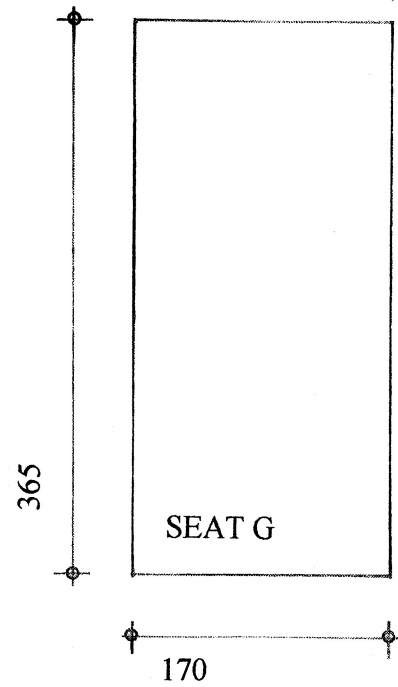
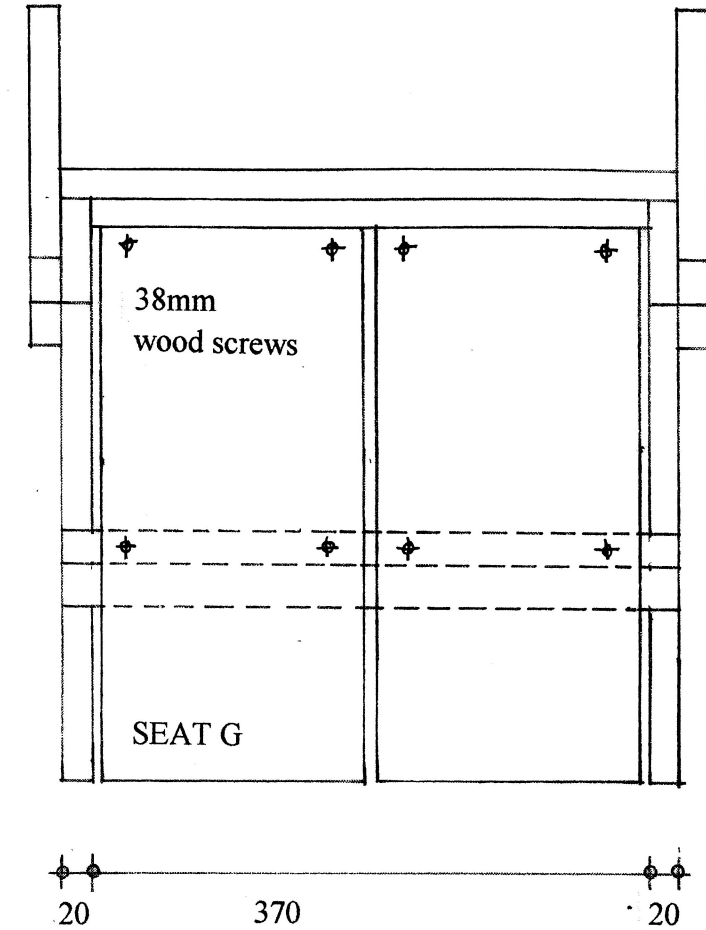

**PUPILS CHAIR: SIZE 5 (17 - 18 YEARS) & ADULT**

**CUTTING LIST**

- SIDE A: 2N°
- SIDE B: 2N°
- BACKREST C/SEAT SUPPORT D: 2N°
- BACKREST E/SEAT SUPPORT F: 2N°
- SEAT G: 2N°

Note: all joints and contact surfaces to be coated with PVA adhesive

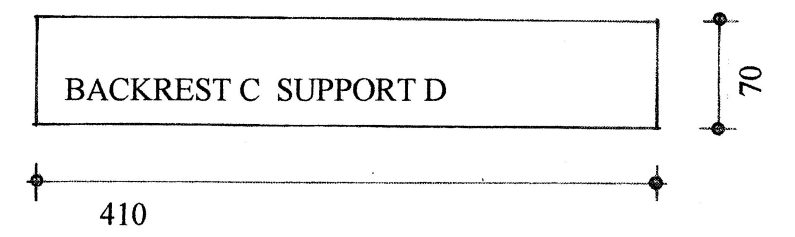
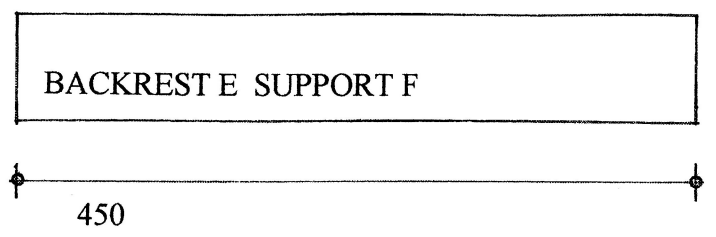
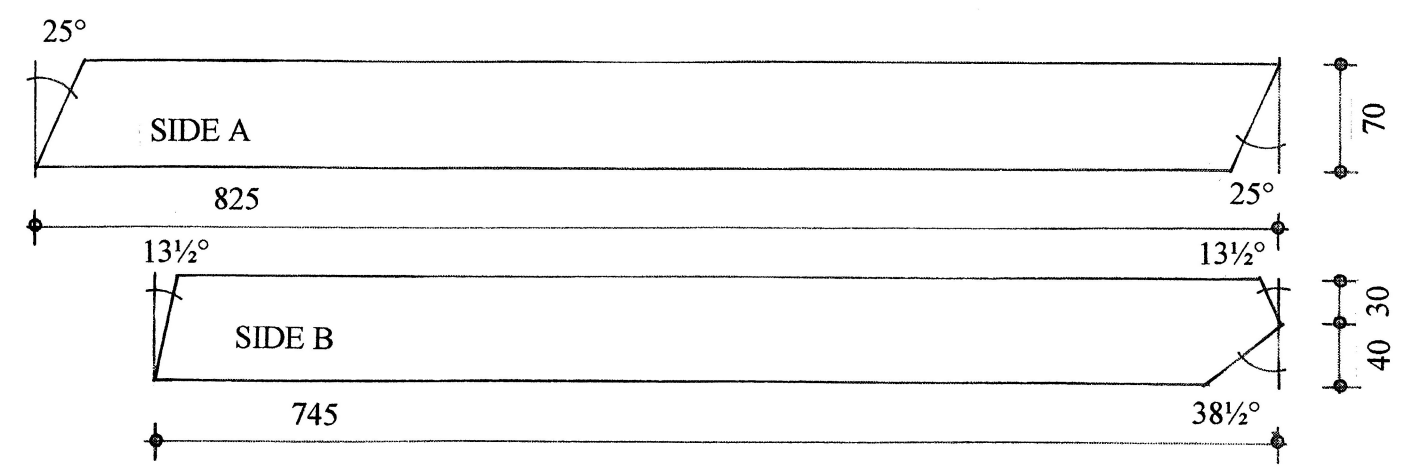
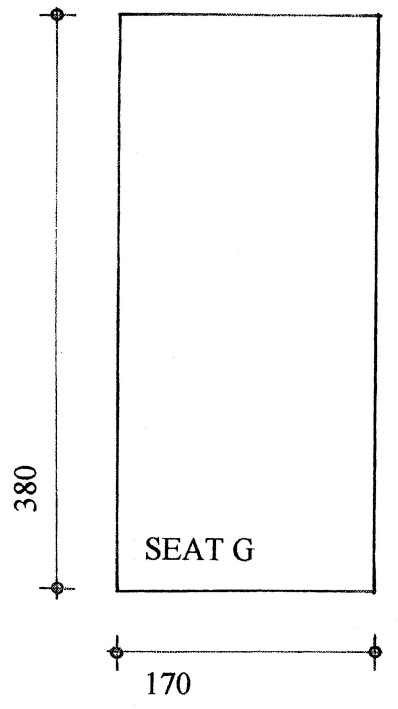
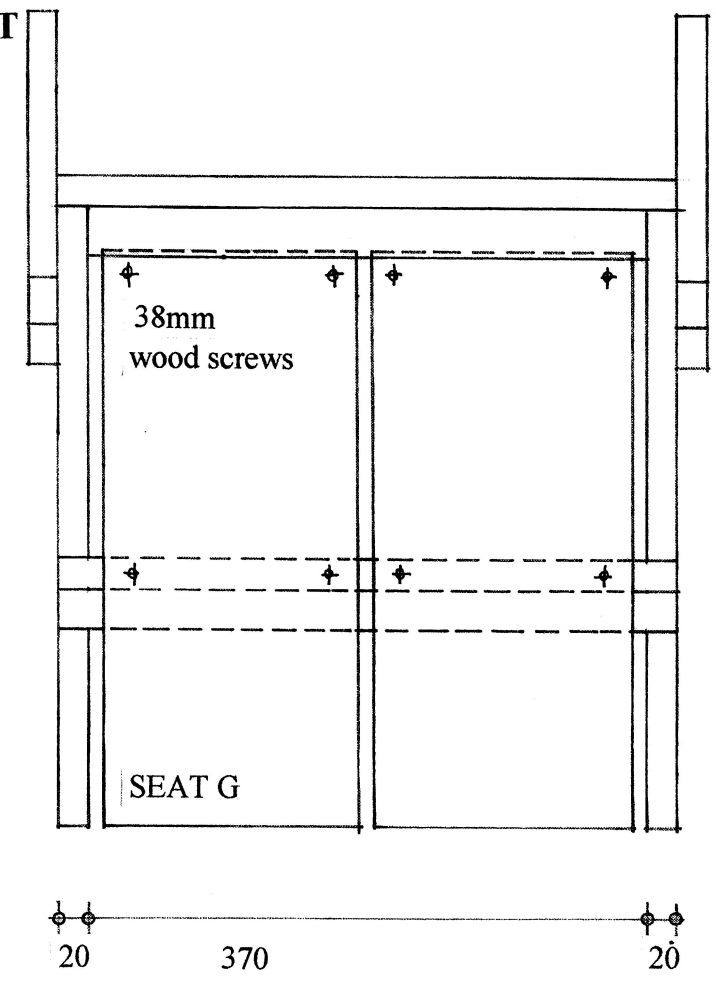
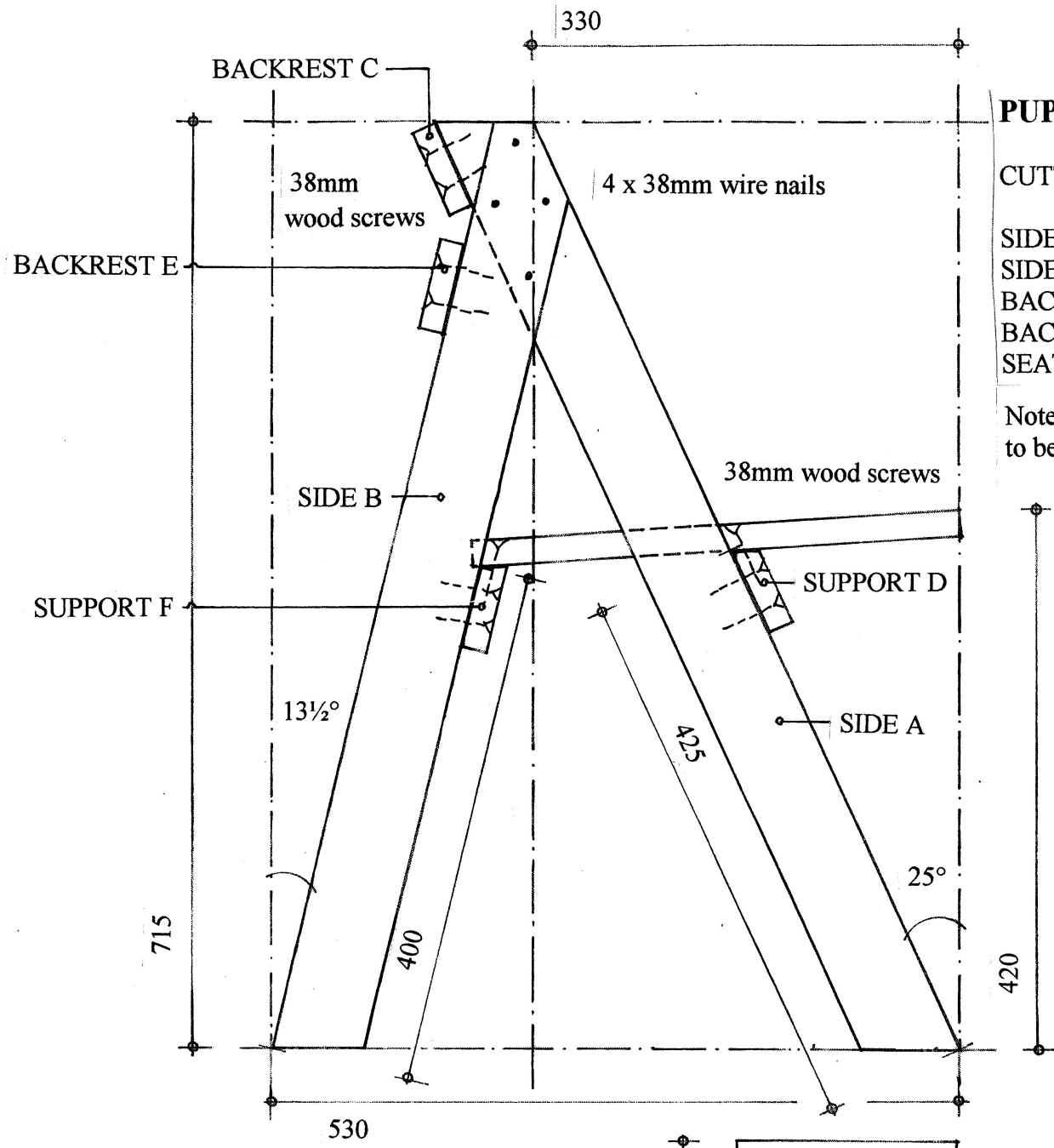

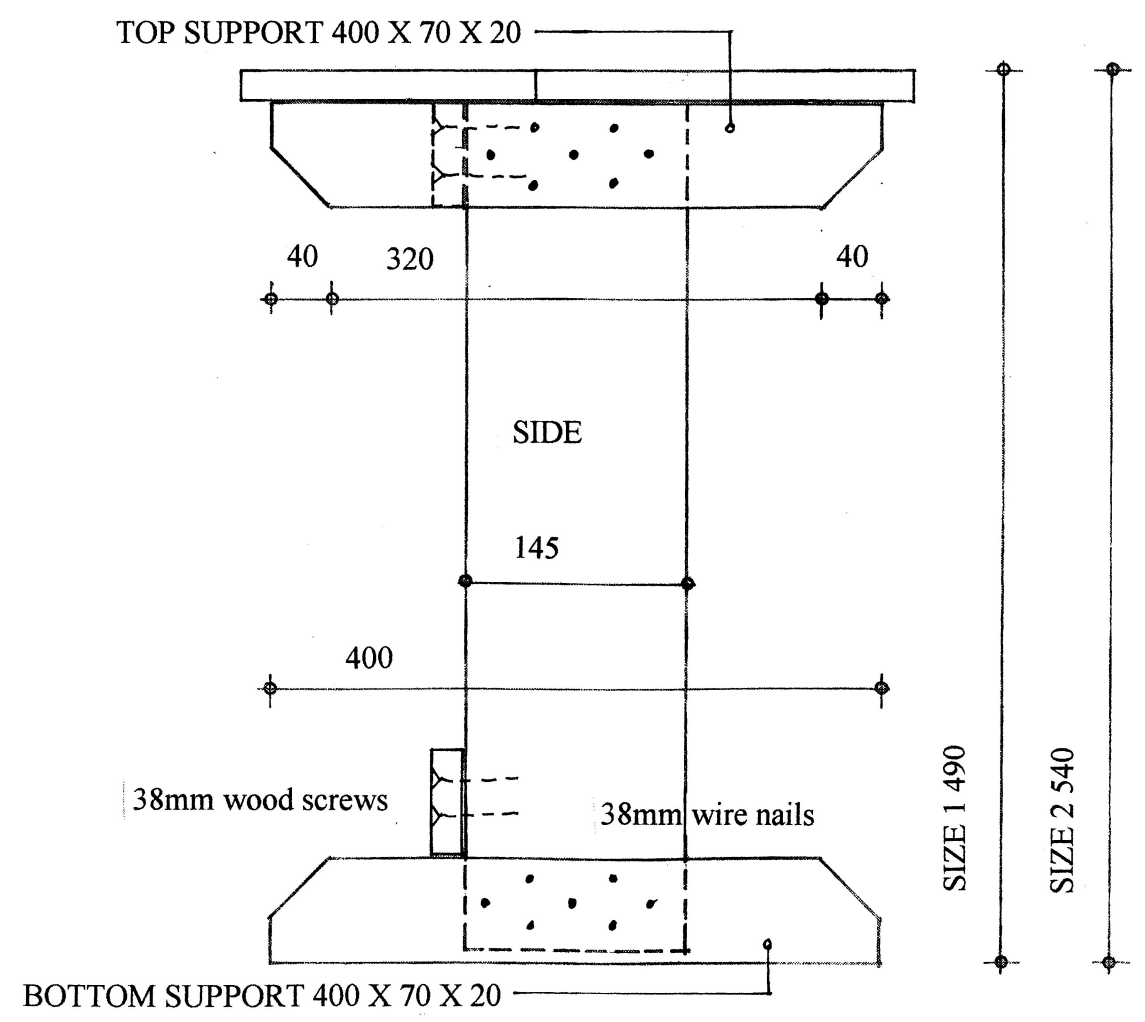
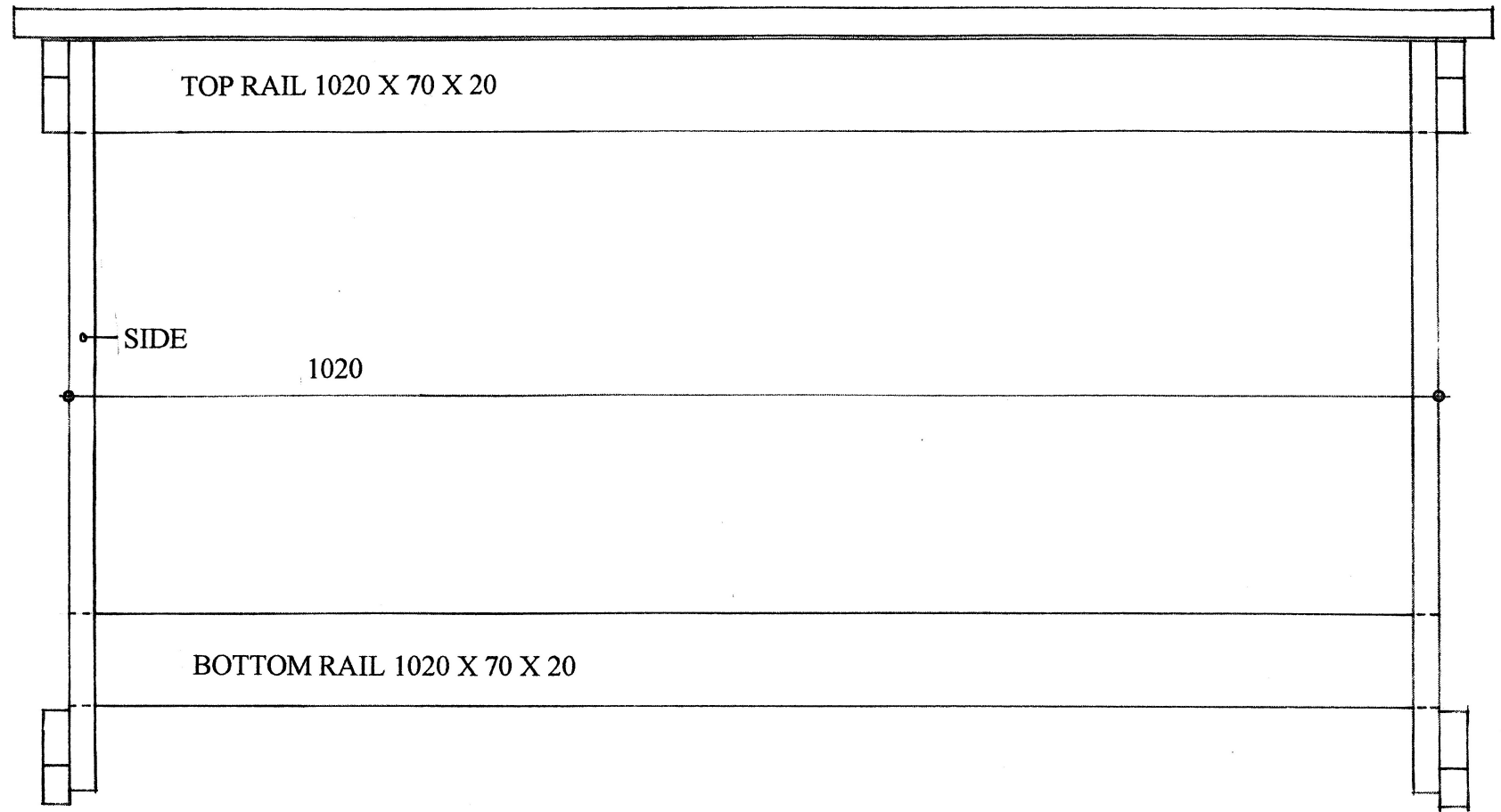
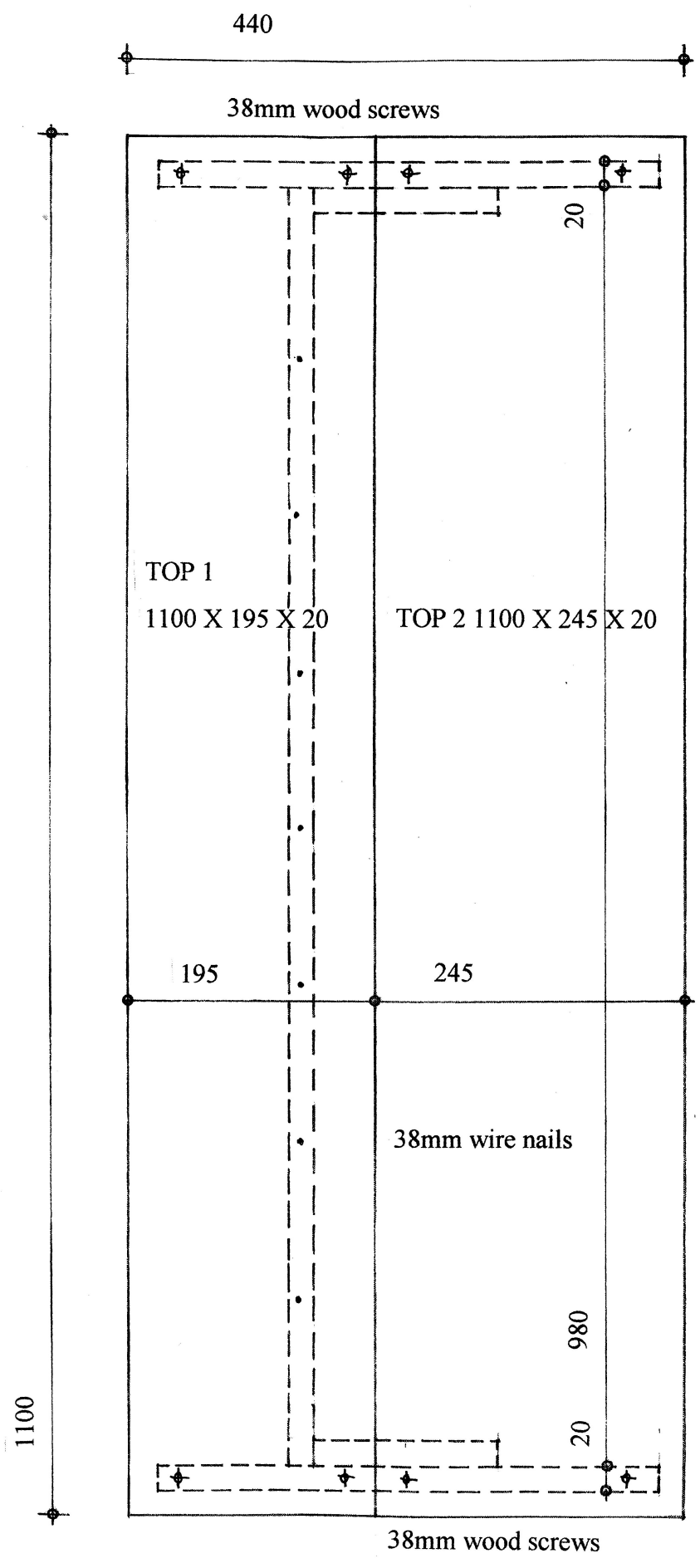

**PUPILS DESK**

**SIZE 1 (6 – 9 YEARS)**  
**SIZE 2 (9 – 12 YEARS)**

Note: all joints and contact surfaces  
to be coated with PVA adhesive

SIDE: SIZE 2 510 X 145 X 20  
SIDE: SIZE 1 490 SIZE 2 540

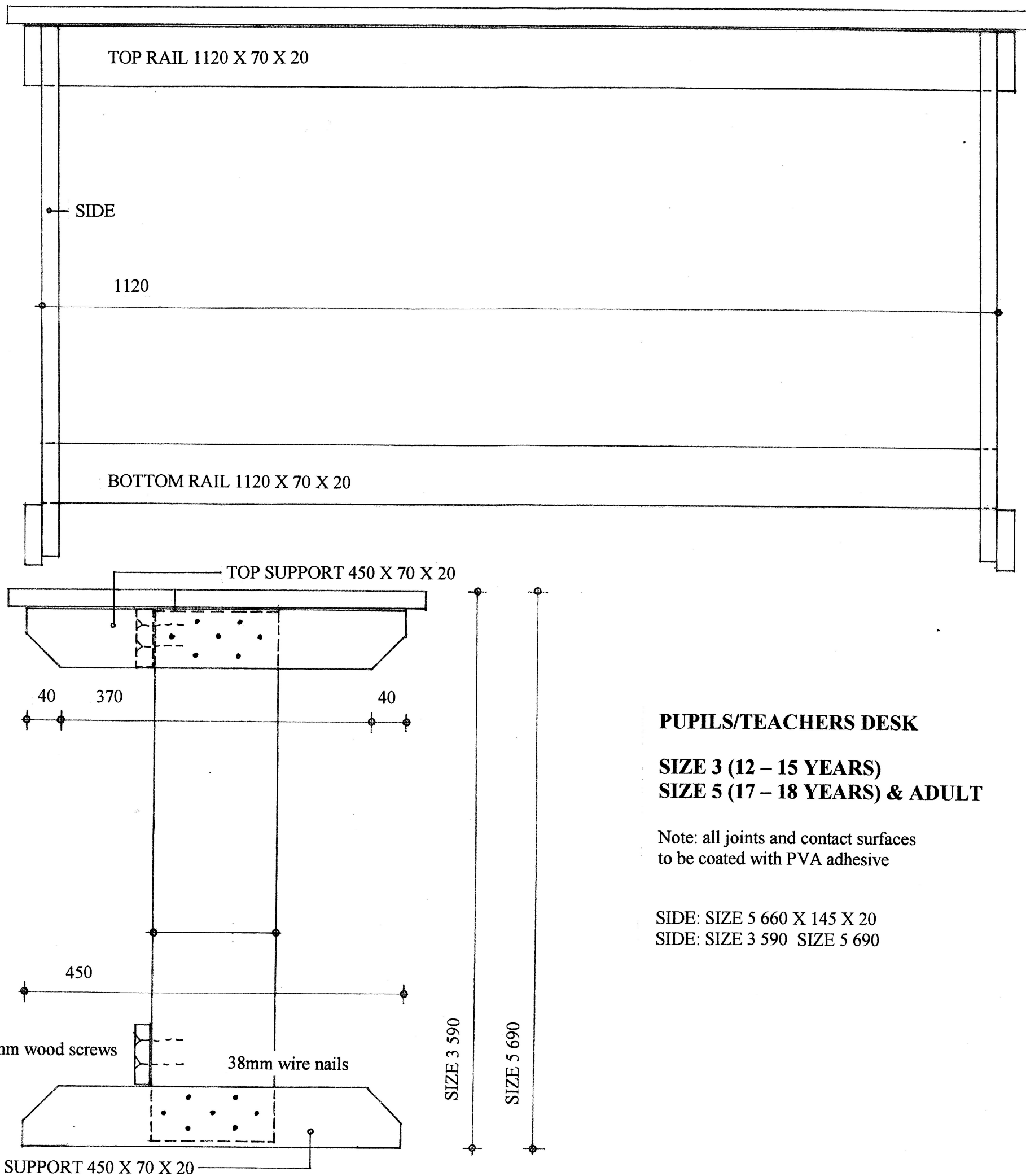
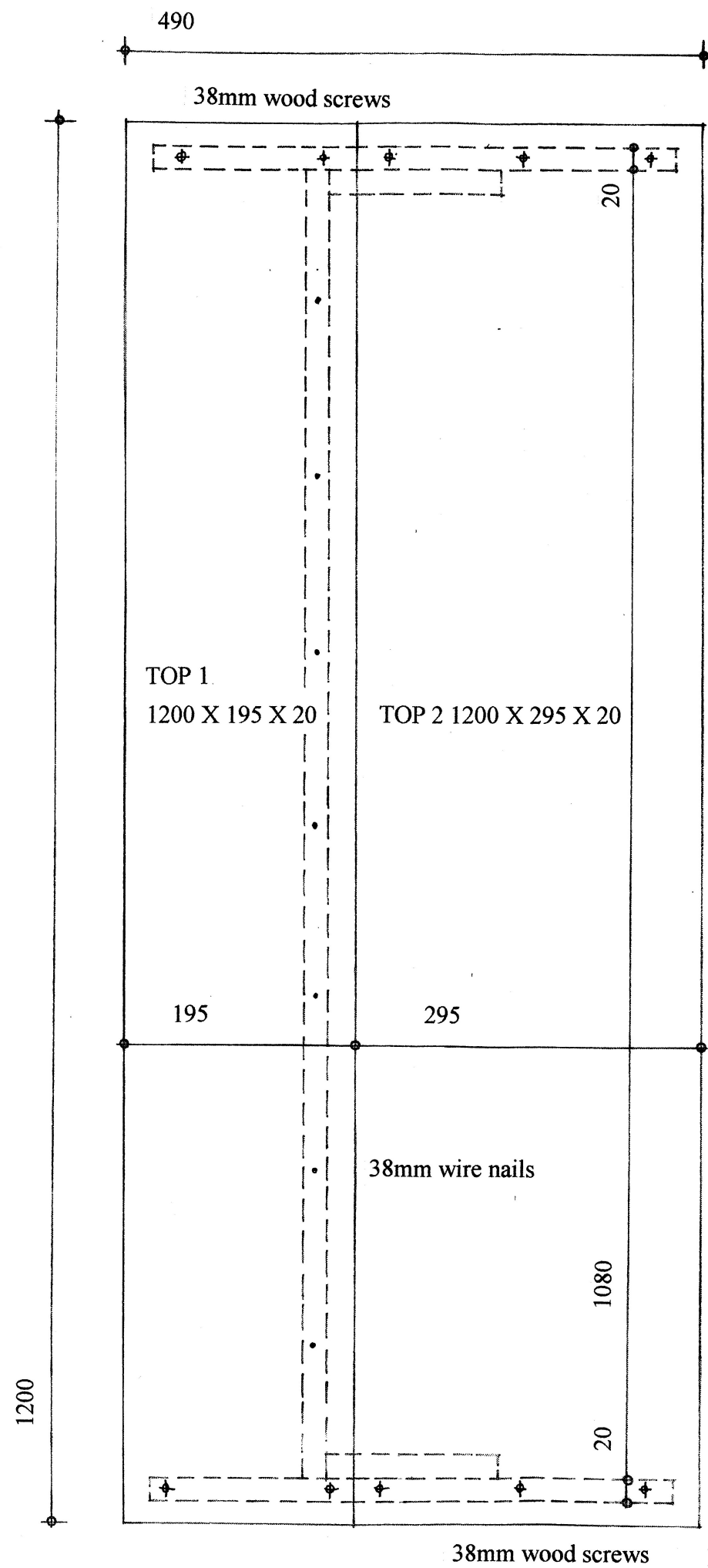

**PUPILS/TEACHERS DESK**

**SIZE 3 (12 – 15 YEARS)**

**SIZE 5 (17 – 18 YEARS) & ADULT**

Note: all joints and contact surfaces  
to be coated with PVA adhesive

SIDE: SIZE 5 660 X 145 X 20

SIDE: SIZE 3 590 SIZE 5 690